

Series
VENTS VUT PB EC

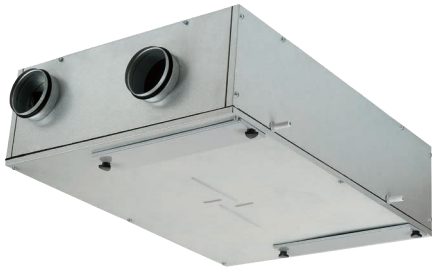

Air handling units in heat- and sound-insulated casing.
Air flow up to 410 m³/h.
Heat recovery efficiency up to 94 %

Description

The VUT PB EC air handling units are the fully-featured ventilation units that ensure air filtration, fresh air supply and stale air extract.

Casing

Made of galvanised steel, internally filled with a 40 mm heat- and sound-insulating layer of mineral wool.

Filter

Built-in panel filters with filtration class F7 provide efficient supply air filtration.
Panel filters with filtration class G4 provide extract air

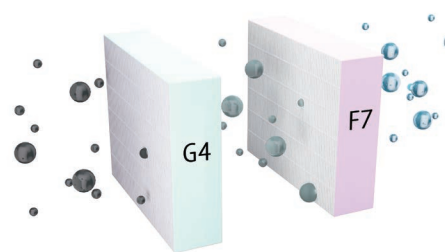

Fans

High-efficient electronically-commutated motors with an external rotor and backward curved blades.

Heat exchanger

The units are equipped with a high-efficient counter-flow polystyrene heat exchanger. In the cold season the extract air heat is captured and transferred to the supply air stream which reduces the ventilation-generated heat losses.

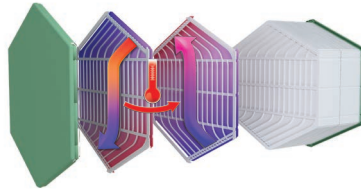

Frost protection

To protect the heat exchanger from freezing in the cold season, the unit has a Frost Protection mode based on the temperature sensor readings. The Frost Protection mode is activated at an exhaust air temperature of +3 °C. After temperature increase the unit returns to the previous operation mode. In case of freezing danger, the supply fan is turned off in VUT 160/250/350 PB EC A14 units.

Three modes of frost protection are available in VUT 160/250/350 PB EC A21 models:

- gradual reduction of the supply fan speed
- with the bypass
- with the electric preheater (available as an accessory).

Bypass

The units are equipped with a 100 % bypass which can be opened for summer cooling.

Control and automation

The **VUT PB EC A21** units are equipped with an integrated automation system.

The A21 controller enables integration of the unit into the **Smart Home System** or **BMS (Building Management Systems)**.

To control the unit via Wi-Fi, download the VENTS Home mobile app.



Google play



Download on the App Store



The **VUT PB EC A14** units are equipped with an integrated automation system and a wall-mounted control panel A14 with LED indication.





Mounting

The units are designed for ceiling or wall mounting (horizontal spigot orientation) in a position allowing condensate collection and removal into a special drain pan. The access for filter maintenance and replacement is available from the bottom panel.

Designation key

Series	Rated air flow [m ³ /h]	Installation type	Bypass	Motor type	Service side	Automation
VENTS VUT	160; 250; 350	P: suspended installation	B: bypass	EC: synchronous electronically commutated motor	L: left R: right	A14 A21

Control and automation

Functions	A21	A14
Wired remote control panel	Option (A22) 	A14 
Control via a wired remote LCD control panel	Option (A25) 	-
Wireless remote control panel	Option (A22 Wi-Fi) 	-
BMS	RS-485 Wi-Fi Ethernet MODBUS (RTU, TCP)	-
Vents Cloud Server service	+	-
Control via Wi-Fi using a mobile application	+	-
Frost protection	+	+
Bypass	Auto + manual	Manual
Week-scheduled operation	+	-
Filter replacement indication	According to filter timer	According to filter timer
	According to filter clogging differential pressure switch readings	
Alarm indication	+	+
Speed selection	+	+
Timers	+	-
RH% sensor	Option	Option
CO ₂ sensor	Option	Option
VOC sensor	Option	Option
PM2.5 sensor	Option	Option
Boost mode	+	-
Fireplace mode	+	-
Preheater connection	Option	-
Reheater connection	Option	-
Cooler connection	Option	-
Fire alarm sensor	Option	Option
Minimum supply air temperature control	+	-

Overall dimensions

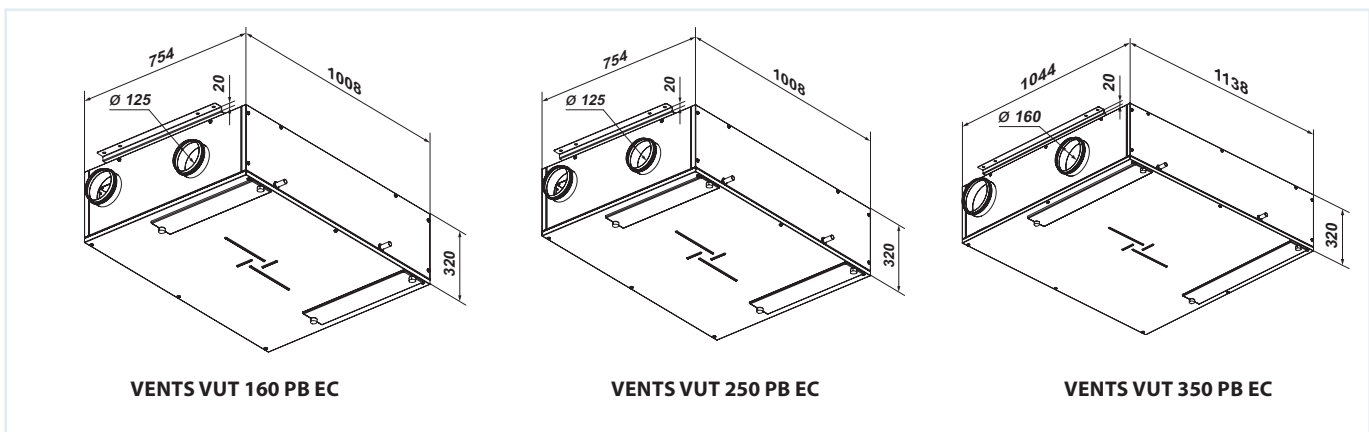

Technical data

	VUT 160 PB EC	VUT 250 PB EC	VUT 350 PB EC
Unit voltage [V/50 (60) Hz]		1~230	
Maximum unit power [W]	50	101	170
Maximum unit current [A]	0.4	0.8	1.3
Maximum air flow [m ³ /h]	190	270	410
Sound pressure level at 3 m distance [dBA]	26	28	34
Transported air temperature [°C]		-25...+40	
Casing material		Aluzinc steel	
Insulation		40 mm mineral wool	
Filter (extract/supply)		G4/F7	
Connected air duct diameter [mm]	Ø 125	Ø 125	Ø 160
Weight [kg]	48	48	70
Heat recovery efficiency [%]	82-94	80-98	80-91
Heat exchanger type		Counter-flow	
SEC class	A+	A	A
Heat exchanger material		Polystyrene	

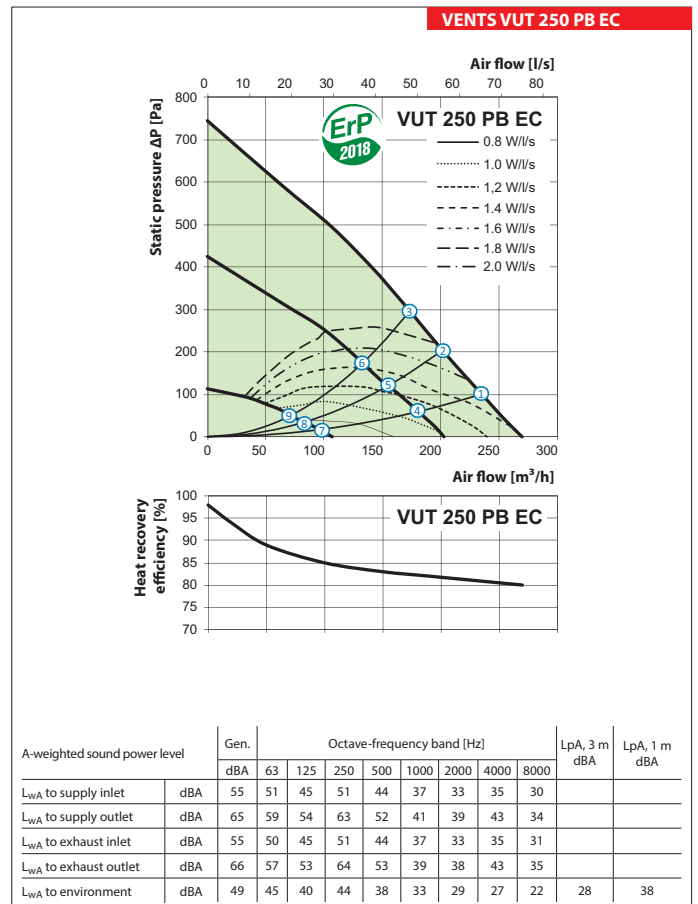
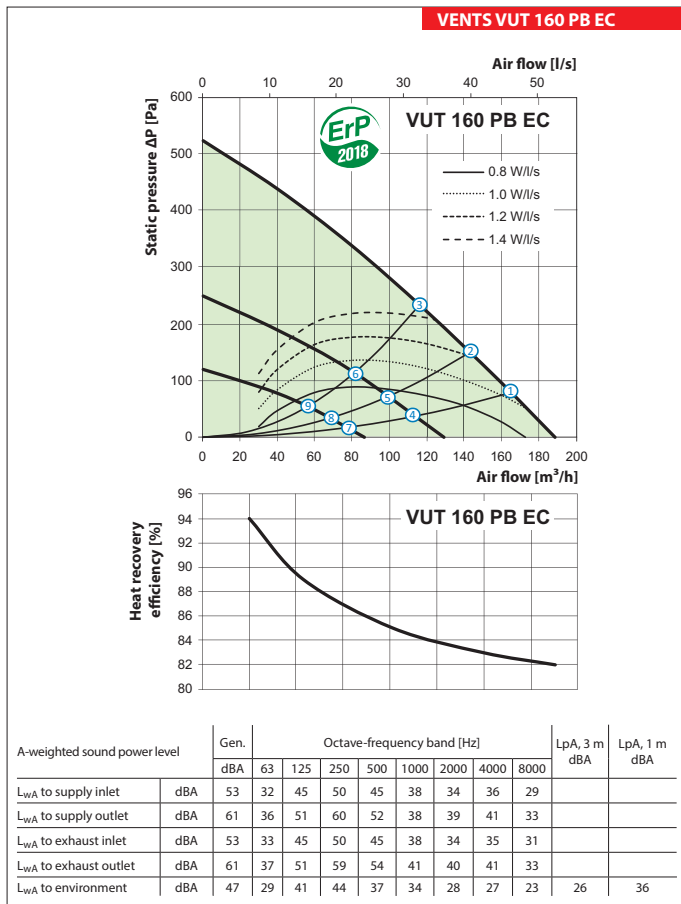

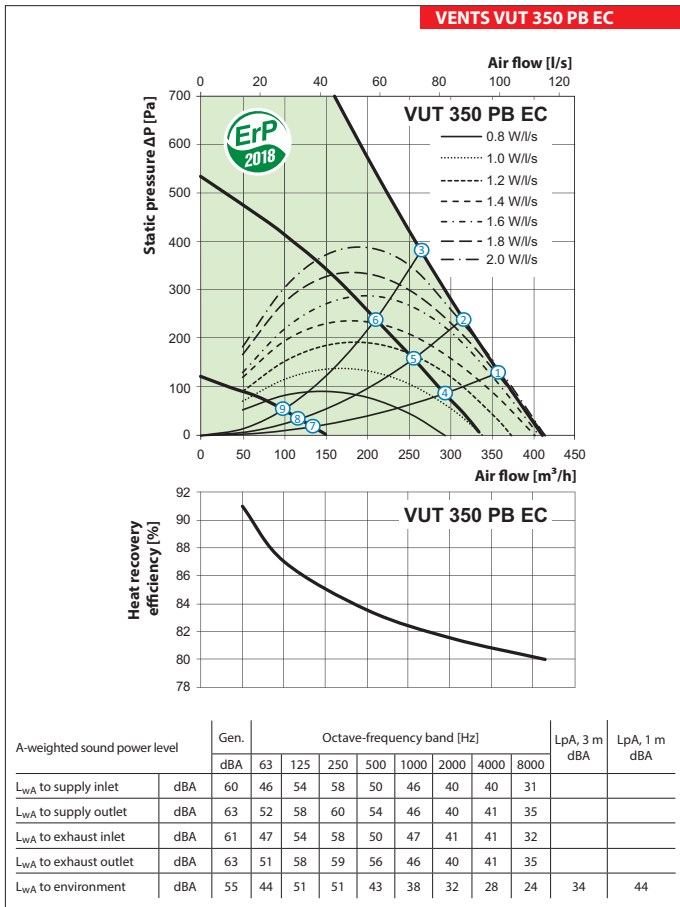

Point	Power [W]			Sound pressure level at 3 m (1 m) distance [dBA]		
	VUT 160 PB EC	VUT 250 PB EC	VUT 350 PB EC	VUT 160 PB EC	VUT 250 PB EC	VUT 350 PB EC
1	49	100	169	26 (36)	28 (38)	34 (44)
2	49	99	169	26 (36)	27 (37)	34 (44)
3	48	98	169	25 (35)	27 (37)	33 (43)
4	21	55	87	22 (32)	23 (33)	28 (38)
5	21	54	86	22 (32)	22 (32)	28 (38)
6	20	54	84	21 (31)	22 (32)	27 (37)
7	8	17	20	19 (29)	15 (25)	22 (32)
8	8	17	19	18 (28)	14 (24)	22 (32)
9	8	16	19	18 (28)	14 (24)	21 (31)

AIR HANDLING UNITS WITH HEAT RECOVERY

Accessories for air handling units

Model	G4 panel filter	F7 panel filter	Control panel	Control panel with WiFi	LCD control panel	Indoor humidity sensor	Outdoor CO ₂ sensor with indication	Outdoor CO ₂ sensor
VUT 160 PB EC A14	SF 403x253x48 G4	SF 403x253x48 F7	-	-	-	HV2	CO2-1	CO2-2
VUT 160 PB EC A21			A22	A22 WiFi	A25			
VUT 250 PB EC A14			-	-	-			
VUT 250 PB EC A21			A22	A22 WiFi	A25			
VUT 350 PB EC A14			-	-	-			
VUT 350 PB EC A21			SF 603x253x48 G4	SF 603x253x48 F7	A22			

Model	Outdoor humidity sensor	Electric heater for preheating	Electric reheater	Hydraulic U-trap	Air damper	Electric actuator
VUT 160 PB EC A14	HR-S	-	-	SH-32	KRV 125	LF230
VUT 160 PB EC A21		NKP 125 A21 V.2	NKD 125 A21 V.2			
VUT 250 PB EC A14		-	-			
VUT 250 PB EC A21		NKP 125 A21 V.2	NKD 125 A21 V.2		KRV 160	
VUT 350 PB EC A14		-	-			
VUT 350 PB EC A21		NKP 160 A21 V.2	NKD 160 A21 V.2			

Application options

