

AOE 24



Die Luftheizungs- und Luftkühlanlagen mit einem Elektro-Heizregister sind geeignet zur Organisation der Luftheizung in verschiedenen Räumen

- Max. Förderleistung: 4000
- Schalldruckpegel LpA @ 3 m: 61
- Motortyp: AC
- Gehäusematerial: Coated steel

	Maßeinheit	AOE 24
Phasen	-	3
Versorgungsspannung min	V	400
Versorgungsspannung max	V	400
Frequenz der Netzversorgung	Hz	50
Leistung	W	253
Stromaufnahme	A	1.1
Max. Förderleistung	m ³ /h	4000
Schalldruckpegel LpA @ 3 m	dB(A)	61
Gewicht	kg	48
Schutzart	-	IP21

Abmessungen

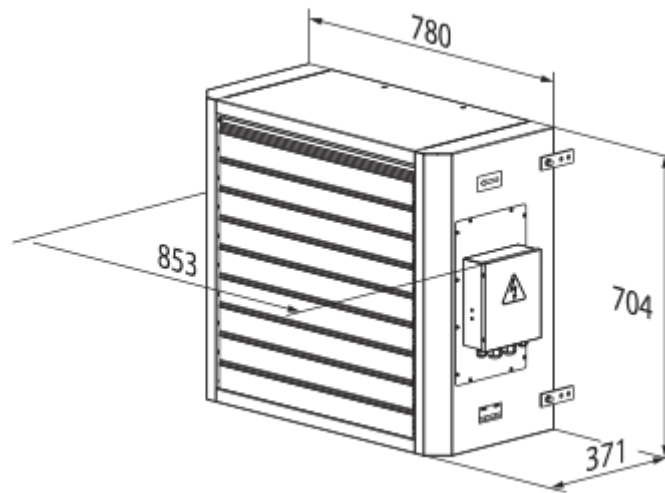

Zubehör

Temperaturregler

Produktname	Foto	Beschreibung
TST-1-300		Temperaturregler
TSTD-1-300		Temperaturregler
RTS-1-400		Temperaturregler
RTSD-1-400		Temperaturregler

Sonstiges Zubehör

Produktname	Foto	Beschreibung
UET-30D		Steuereinheit
MKP-AOW		Montagewinkel
MK-AOW 45		Konsolen