

## AOE 30



Die Luftheizungs- und Luftkühlanlagen mit einem Elektro-Heizregister sind geeignet zur Organisation der Luftheizung in verschiedenen Räumen

- Max. Förderleistung: 4000
- Schalldruckpegel LpA @ 3 m: 61
- Motortyp: AC
- Gehäusematerial: Beschichteter Stahl

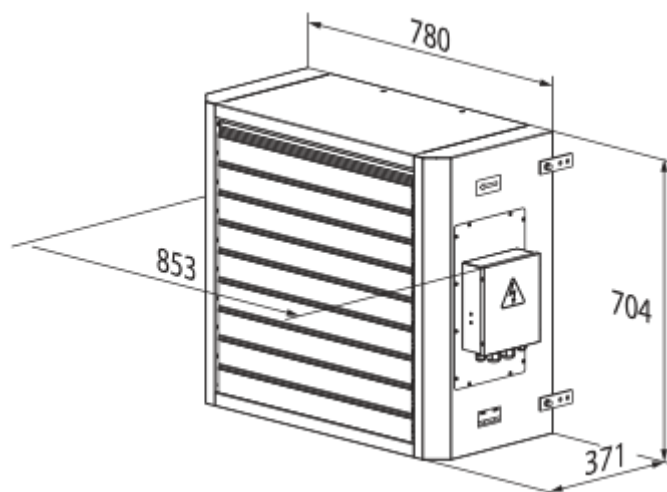

	Maßeinheit	AOE 30
Phasen	-	3
Versorgungsspannung min	V	400
Versorgungsspannung max	V	400
Frequenz der Netzversorgung	Hz	50
Leistung	W	253
Stromaufnahme	A	1.1
Max. Förderleistung	m <sup>3</sup> /h	4000
Schalldruckpegel LpA @ 3 m	dB(A)	61
Gewicht	kg	48
Schutzart	-	IP21

### Abmessungen



## Zubehör

### Temperaturregler

Produktname	Foto	Beschreibung
<a href="#">TST-1-300</a>		Temperaturregler
<a href="#">TSTD-1-300</a>		Temperaturregler
<a href="#">RTS-1-400</a>		Temperaturregler
<a href="#">RTSD-1-400</a>		Temperaturregler

### Sonstiges Zubehör

Produktname	Foto	Beschreibung
UET-30D		Steuereinheit
MKP-AOW		Montagewinkel
MK-AOW 45		Konsolen