

AOE 9



Die Luftheizungs- und Luftkühlanlagen mit einem Elektro-Heizregister sind geeignet zur Organisation der Luftheizung in verschiedenen Räumen

- Max. Förderleistung: 2300
- Schalldruckpegel LpA @ 3 m: 55
- Motortyp: AC
- Gehäusematerial: Coated steel

	Maßeinheit	AOE 9
Phasen	-	3
Versorgungsspannung min	V	400
Versorgungsspannung max	V	400
Frequenz der Netzversorgung	Hz	50
Leistung	W	140
Stromaufnahme	A	0.61
Max. Förderleistung	m ³ /h	2300
Schalldruckpegel LpA @ 3 m	dB(A)	55
Gewicht	kg	32
Schutzart	-	IP21

Abmessungen

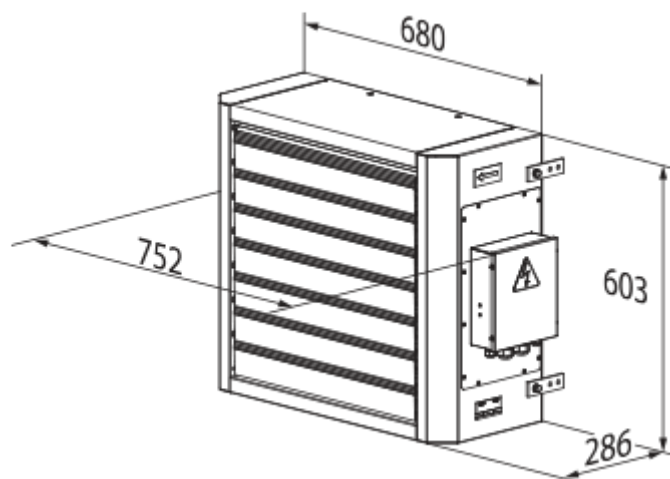

Zubehör

Temperaturregler

Produktname	Foto	Beschreibung
TST-1-300		Temperaturregler
TSTD-1-300		Temperaturregler
RTS-1-400		Temperaturregler
RTSD-1-400		Temperaturregler

Sonstiges Zubehör

Produktname	Foto	Beschreibung
UET-15D		Steuereinheit
MKP-AOW		Montagewinkel
MK-AOW 25		Konsolen