

AOW1 30

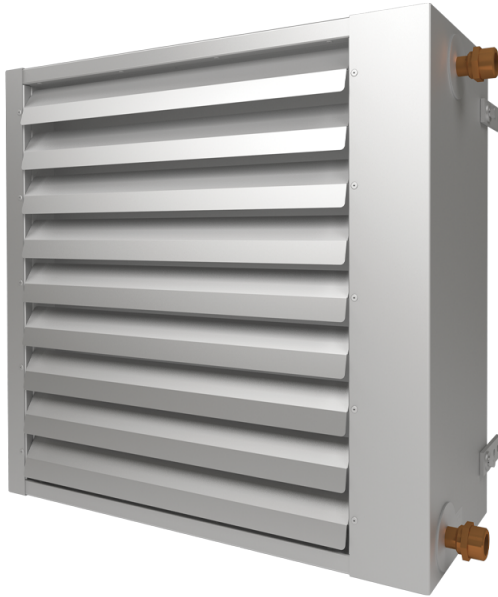

Die Geräte mit einem Warmwasser-Heizregister sind geeignet zur Organisation der rationellen und wirksamen Luftheizung in verschiedenen Räumen

- Max. Förderleistung: 3000
- Schalldruckpegel LpA @ 3 m: 55
- Motortyp: AC
- Gehäusematerial: Coated steel

	Maßeinheit	AOW1 30
Phasen	-	1
Versorgungsspannung min	V	230
Versorgungsspannung max	V	230
Frequenz der Netzversorgung	Hz	50
Leistung	W	191
Stromaufnahme	A	0.85
Max. Förderleistung	m ³ /h	3000
Schalldruckpegel LpA @ 3 m	dB(A)	55
Gewicht	kg	31
Schutzart	-	IP44

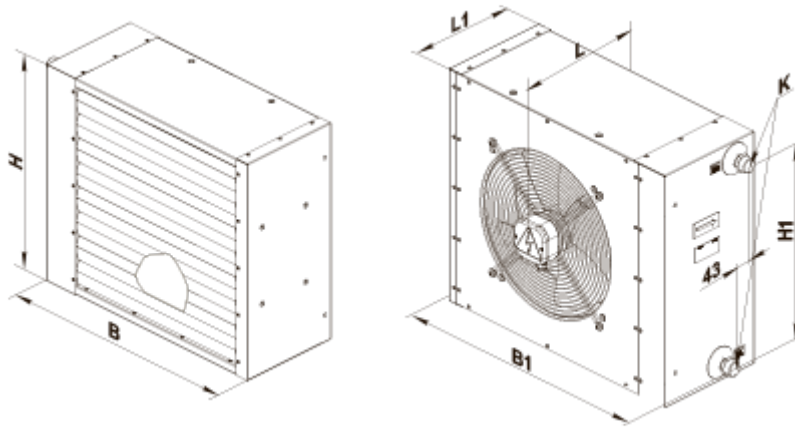

Abmessungen

B	B1	H	H1	L	L1	K
630	690	605	518	355	262	G 3/4"



Zubehör

Sonstiges Zubehör

Produktname	Foto	Beschreibung
UWT-1E		Steuereinheit
MKP-AOW		Montagewinkel
MK-AOW 25		Konsolen

Temperaturregler

Produktname	Foto	Beschreibung
TST-1-300		Temperaturregler
TSTD-1-300		Temperaturregler
RTS-1-400		Temperaturregler
RTSD-1-400		Temperaturregler