

KDT-MK 200

Kanaltemperatursensoren mit Anschlusskasten

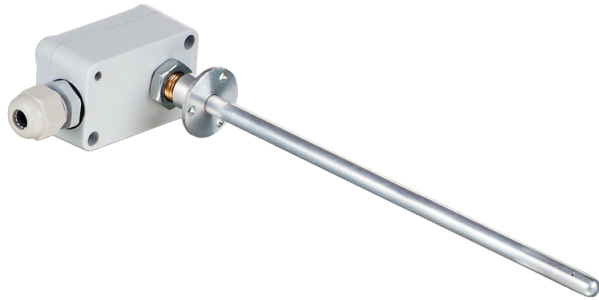

	Maßeinheit	KDT-MK 200
Versorgungsspannung max	V	5
Ambientlufttemperatur, min	°C	-30
Ambientlufttemperatur, max	°C	60
Schutzart	-	IP54

Abmessungen

L
200

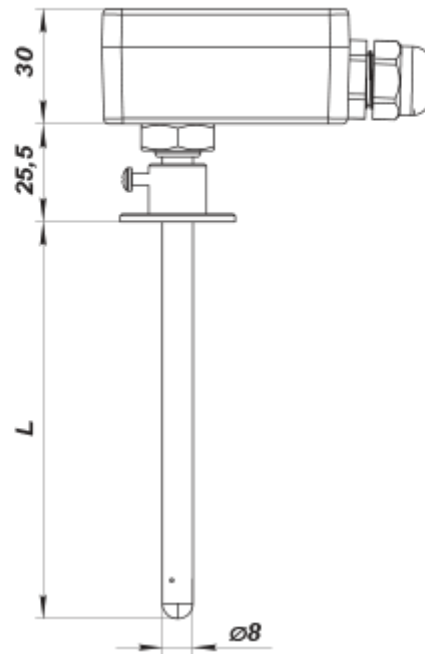
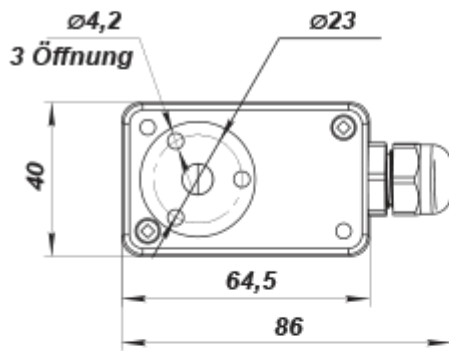

In dieser Abb. wird der
Deckel nicht gezeigt.

