

NK 600x350-12,0-3

Rohr-Elektro-Heizregister mit einem rechteckigen Querschnitt

- Gehäusematerial: Verzinkter Stahl



	Maßeinheit	NK 600x350-12,0-3
Phasen	-	3
Minimale Versorgungsspannung	V	400
Maximale Versorgungsspannung	V	400
Netzfrequenz	Hz	50
Nennleistung	W	12000
Gewicht	kg	9.75





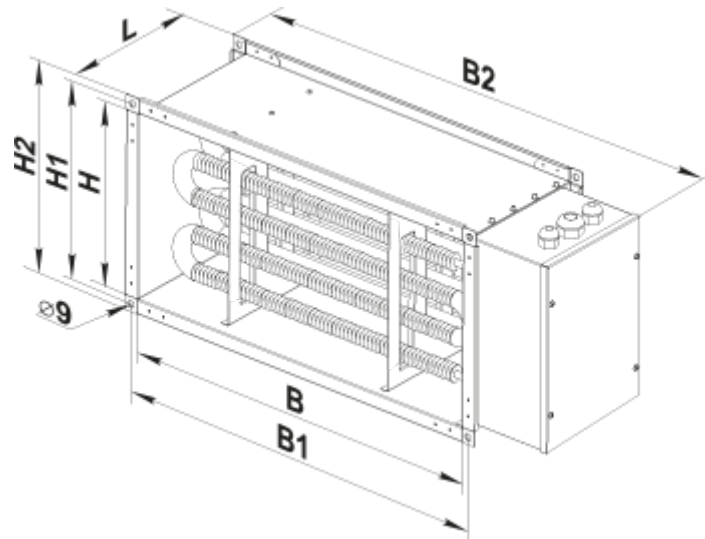



Abmessungen



B	B1	B2	H	H1	H2	L
600	620	740	350	370	390	200



Zubehör

Externer Temperaturregler

Produktname	Foto	Beschreibung
KDT2-M 100		Kanal-Temperatursensoren
KDT2-M 150		Kanal-Temperatursensoren
KDT2-M 200		Kanal-Temperatursensoren
KDT2-M 400		Kanal-Temperatursensoren
KDT2-M1 100		Kanal-Temperatursensoren
KDT2-M1 150		Kanal-Temperatursensoren
KDT2-M1 200		Kanal-Temperatursensoren
KDT2-M1 400		Kanal-Temperatursensoren
KDT2-MK 100		Kanaltemperatursensoren mit Anschlusskasten

KDT2-MK 150		Kanaltemperatursensoren mit Anschlusskasten
KDT2-MK 200		Kanaltemperatursensoren mit Anschlusskasten
KDT2-MK 400		Kanaltemperatursensoren mit Anschlusskasten

Elektrische Triac-Temperaturregler

Produktname	Foto	Beschreibung
RNS-16		Triac Leistungssteller für Elektro-Heizregister
RNS-25		Triac Leistungssteller für Elektro-Heizregister