

# TwinFresh Comfo RA1-50-2 V.3



Die benutzerfreundliche Lüftungsanlage TwinFresh Comfo sorgt für frische und saubere Luft mit einer idealen Luftfeuchtigkeit in Ihrem Haus

- Förderleistung im Regenerationsbetrieb: 25
- Schalldruckpegel LpA @ 3 m: 23
- Schalldruckpegel @ 1 m: 32
- Wärmetauschertyp: Regenerativer
- Filter: G3 (G4 F7 опційно)
- Schalldämmung
- Motortyp: EC
- Steuerung: Remote Control
- Gehäusematerial: Plastic
- Feuchtigkeitssensor: Built-in

	Maßeinheit	TwinFresh Comfo RA1-50-2 V.3		
Speed	-	3		
Versorgungsspannung min	V	100		
Versorgungsspannung max	V	240		
Frequenz der Netzversorgung	Hz	50/60		
Leistung	W	4.50	5.00	7.00
Stromaufnahme	A	0.024	0.026	0.039
Förderleistung im Lüftungsbetrieb	m <sup>3</sup> /h	20	35	50
Förderleistung im Regenerationsbetrieb	m <sup>3</sup> /h	10	18	25
Schalldruckpegel LpA @ 3 m	dB(A)	13	20	23
Schalldruckpegel @ 1 m	dB(A)	22	29	32
Effizienz der Wärmerückgewinnung, max	%	88		
Wärmetauschertyp	-	Regenerativer		
Wärmetauschermaterial	-	Ceramic		
Filter	-	G3 (G4 F7 опційно)		
Fördermitteltemperatur max	°C	40		
Fördermitteltemperatur min	°C	-20		
Ambientlufttemperatur, min	°C	1		
Ambientlufttemperatur, max	°C	40		
Umgebungsluftfeuchtigkeit, max	%	65		

Schutzart

-

IP24



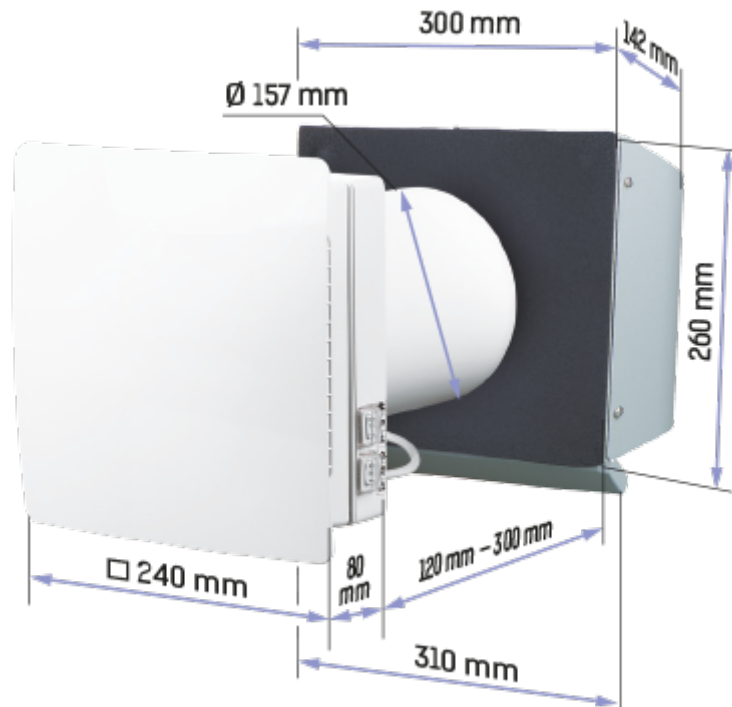





## Abmessungen



## Zubehör

### Sonstiges Zubehör

Produktname	Foto	Beschreibung
<a href="#">EH-14 beige 160</a>		Kunststoff- Lüftungshaube
<a href="#">EH-14 black 160</a>		Kunststoff- Lüftungshaube
<a href="#">EH-14 brown 160</a>		Kunststoff- Lüftungshaube
<a href="#">EH-14 chrome 160</a>		Kunststoff- Lüftungshaube
<a href="#">EH-14 grey 160</a>		Kunststoff- Lüftungshaube

<a href="#">EH-14 terracotta 160</a>		Kunststoff- Lüftungshaube
<a href="#">EH-14 white 160</a>		Kunststoff- Lüftungshaube
<a href="#">EH-17 beige 160</a>		Kunststoff- Lüftungshaube
<a href="#">EH-17 black 160</a>		Kunststoff- Lüftungshaube
<a href="#">EH-17 brown 160</a>		Kunststoff- Lüftungshaube
<a href="#">EH-17 grey 160</a>		Kunststoff- Lüftungshaube
<a href="#">EH-17 terracotta 160</a>		Kunststoff- Lüftungshaube
<a href="#">EH-17 white 160</a>		Kunststoff- Lüftungshaube
<a href="#">MVVM 162 05</a>		Außenlüftungshaube

### Sonstiges Zubehör

Produktname	Foto	Beschreibung
EH-2 chrome 160		Lüftungshaube für dünne Wände
EH-2 grey 160		Lüftungshaube für dünne Wände
EH-13 chrome 160		Lüftungshaube für kalte Klimazonen
EH-13 white 160		Lüftungshaube für kalte Klimazonen
TwinFresh R-50		Bausatz für Vormontage

TwinFresh Comfo RA1-50 V.3 completion kit		Fertigstellungssatz (für das Modell TwinFresh Comfo RA1-50 V.3)
RC TwinFresh Comfo R-50		Fernsteuerung
SF TwinFresh R-50 G3		Filtersatz G3 (2 Stk.)
SFC 150x50 F7		Filter
SFC 150x50 G4		Filter

### Sonstiges Zubehör

Produktname	Foto	Beschreibung
<a href="#">MVMO 150 bV1s An</a>		Runde Metallgitter für Be- und Entlüftung

### Flache Rohre

Produktname	Foto	Beschreibung
<a href="#">3805</a>		Wandmontage
<a href="#">3810</a>		Wandmontage