

TwinFresh Comfo RA1-50-5 V.3



Kleinraum-HRV-Gerät mit Keramik-Wärmetauscher und Fernbedienung, mit einer Förderleistung von 50 m³/h

- Förderleistung im Regenerationsbetrieb: 25
- Schalldruckpegel LpA @ 3 m: 23
- Schalldruckpegel @ 1 m: 32
- Wärmetauschertyp: Regenerativer
- Filter: G3 (G4 F7 optional)
- Schalldämmung
- Motortyp: EC
- Steuerung: Fernbedienung
- Gehäusematerial: Kunststoff
- Feuchtigkeitssensor: Built-in

	Maßeinheit	TwinFresh Comfo RA1-50-5 V.3		
Speed	-	3		
Versorgungsspannung min	V	100		
Versorgungsspannung max	V	240		
Frequenz der Netzversorgung	Hz	50/60		
Leistung	W	4.50	5.00	7.00
Stromaufnahme	A	0.024	0.026	0.039
Förderleistung im Lüftungsbetrieb	m ³ /h	20	35	50
Förderleistung im Regenerationsbetrieb	m ³ /h	10	18	25
Schalldruckpegel LpA @ 3 m	dB(A)	13	20	23
Schalldruckpegel @ 1 m	dB(A)	22	29	32
Effizienz der Wärmerückgewinnung, max	%	88		
Wärmetauschertyp	-	Regenerativer		
Wärmetauschermaterial	-	Ceramic		
Filter	-	G3 (G4 F7 optional)		
Fördermitteltemperatur max	°C	40		
Fördermitteltemperatur min	°C	-20		
Ambientlufttemperatur, min	°C	1		
Ambientlufttemperatur, max	°C	40		
Umgebungsluftfeuchtigkeit, max	%	65		

Schutzart	-	IP24
-----------	---	------



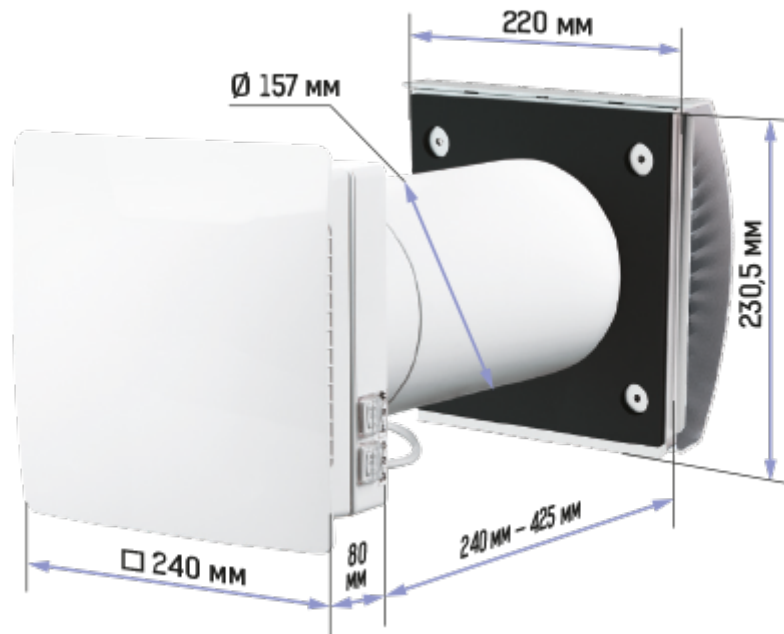





Abmessungen



Zubehör

Kunststoff

Produktname	Foto	Beschreibung
EH-14 beige 160		Kunststoff- Lüftungshaube
EH-14 black 160		Kunststoff- Lüftungshaube
EH-14 brown 160		Kunststoff- Lüftungshaube
EH-14 chrome 160		Kunststoff- Lüftungshaube
EH-14 grey 160		Kunststoff- Lüftungshaube
EH-14 terracotta 160		Kunststoff- Lüftungshaube

EH-14 white 160		Kunststoff- Lüftungshaube
EH-17 beige 160		Kunststoff- Lüftungshaube
EH-17 black 160		Kunststoff- Lüftungshaube
EH-17 brown 160		Kunststoff- Lüftungshaube
EH-17 grey 160		Kunststoff- Lüftungshaube
EH-17 terracotta 160		Kunststoff- Lüftungshaube
EH-17 white 160		Kunststoff- Lüftungshaube
MVVM 162 05		Außenlüftungshaube

Sonstiges Zubehör



Produktname	Foto	Beschreibung
EH-2 chrome 160		Lüftungshaube für dünne Wände
EH-2 grey 160		Lüftungshaube für dünne Wände
EH-13 chrome 160		Lüftungshaube für kalte Klimazonen
EH-13 white 160		Lüftungshaube für kalte Klimazonen
TwinFresh R-50		Bausatz für Vormontage
TwinFresh Comfo RA1-50 V.3 completion kit		Fertigstellungssatz (für das Modell TwinFresh Comfo RA1-50 V.3)

RC TwinFresh Comfo R-50		Fernsteuerung
SF TwinFresh R-50 G3		Filtersatz G3 (2 Stk.)
SFC 150x50 F7		Filter
SFC 150x50 G4		Filter

Metallrohre

Produktname	Foto	Beschreibung
MVMO 150 bV1s An		Runde Metallgitter für Be- und Entlüftung

Flache Rohre

Produktname	Foto	Beschreibung
3805		Wandmontage
3810		Wandmontage