

TwinFresh Comfo RA1-85-1 V.3



Die benutzerfreundliche Lüftungsanlage TwinFresh Comfo sorgt für frische und saubere Luft mit einer idealen Luftfeuchtigkeit in Ihrem Haus

- Förderleistung im Regenerationsbetrieb: 43
- Schalldruckpegel LpA @ 3 m: 34
- Schalldruckpegel @ 1 m: 44
- Wärmetauschertyp: Regenerativer
- Filter: G3 (G4 F7 optional), G3 (G4 F7 опционально)
- Schalldämmung
- Motortyp: EC
- Steuerung: Remote Control
- Gehäusematerial: Plastic
- Feuchtigkeitssensor: Built-in

	Maßeinheit	TwinFresh Comfo RA1-85-1 V.3		
Speed	-	3		
Versorgungsspannung min	V	100		
Versorgungsspannung max	V	240		
Frequenz der Netzversorgung	Hz	50/60		
Leistung	W	4.74	6.56	9.65
Stromaufnahme	A	0.034	0.050	0.071
Förderleistung im Lüftungsbetrieb	m ³ /h	36	59	85
Förderleistung im Regenerationsbetrieb	m ³ /h	18	30	43
Schalldruckpegel LpA @ 3 m	dB(A)	19	25	34
Schalldruckpegel @ 1 m	dB(A)	29	35	44
Effizienz der Wärmerückgewinnung, max	%	90		
Wärmetauschertyp	-	Regenerativer		
Wärmetauschermaterial	-	Ceramic		
Filter	-	G3 (G4 F7 optional), G3 (G4 F7 опционально)		
Fördermitteltemperatur max	°C	40		
Fördermitteltemperatur min	°C	-20		
Ambientlufttemperatur, min	°C	1		
Ambientlufttemperatur, max	°C	40		
Umgebungsluftfeuchtigkeit, max	%	65		



Schutzart	-	IP24
-----------	---	------

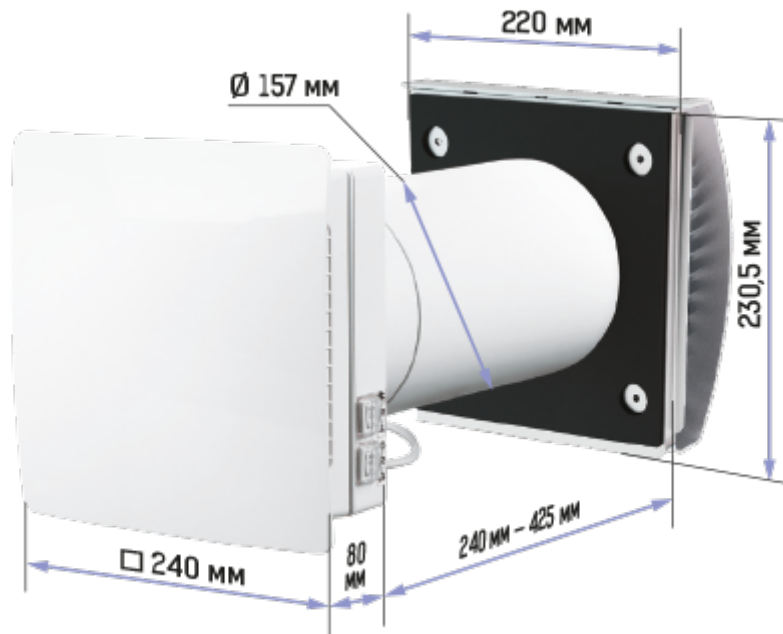













Abmessungen



Zubehör

Sonstiges Zubehör

Produktname	Foto	Beschreibung
EH-14 beige 160		Kunststoff- Lüftungshaube
EH-14 black 160		Kunststoff- Lüftungshaube
EH-14 brown 160		Kunststoff- Lüftungshaube
EH-14 chrome 160		Kunststoff- Lüftungshaube
EH-14 grey 160		Kunststoff- Lüftungshaube
EH-14 terracotta 160		Kunststoff- Lüftungshaube



EH-14 white 160		Kunststoff- Lüftungshaube
EH-17 beige 160		Kunststoff- Lüftungshaube
EH-17 black 160		Kunststoff- Lüftungshaube
EH-17 brown 160		Kunststoff- Lüftungshaube
EH-17 grey 160		Kunststoff- Lüftungshaube
EH-17 terracotta 160		Kunststoff- Lüftungshaube
EH-17 white 160		Kunststoff- Lüftungshaube
EH-2 chrome 160		Lüftungshaube für dünne Wände
EH-2 grey 160		Lüftungshaube für dünne Wände
EH-13 chrome 160		Lüftungshaube für kalte Klimazonen
EH-13 white 160		Lüftungshaube für kalte Klimazonen
MVVM 162 05		Außenlüftungshaube
TwinFresh R-50		Bausatz für Vormontage
TwinFresh Comfo RA1-50 V.3 completion kit		Fertigstellungssatz (für das Modell TwinFresh Comfo RA1-50 V.3)
RC TwinFresh Comfo R-50		Fernsteuerung

SF TwinFresh R-50 G3		Filtersatz G3 (2 Stk.)
SFC 150x50 F7		Filter
SFC 150x50 G4		Filter

Metallrohre

Produktname	Foto	Beschreibung
MVMO 150 bV1s An		Runde Metallgitter für Be- und Entlüftung

Flache Rohre

Produktname	Foto	Beschreibung
3805		Wandmontage
3810		Wandmontage