

TwinFresh Easy-D RL7-50-17



Kleinraum-HRV-Geräte mit Keramik-Wärmetauscher und einer Förderleistung von 50 m³/h

- Förderleistung im Regenerationsbetrieb: 50
- Schalldruckpegel LpA @ 3 m: 20
- Schalldruckpegel @ 1 m: 29
- Wärmetauschertyp: Regenerativer
- Filter: G3 (Option: F8)
- Schalldämmung
- Motortyp: EC
- Steuerung: Wired control panel
- Gehäusematerial: Kunststoff

	Maßeinheit	TwinFresh Easy-D RL7-50-17		
Speed	-	3		
Versorgungsspannung min	V	100		
Versorgungsspannung max	V	240		
Frequenz der Netzversorgung	Hz	50/60		
Leistung	W	2.37	3.80	7.61
Stromaufnahme	A	0.033	0.047	0.080
Förderleistung im Lüftungsbetrieb	m ³ /h	15	35	50
Förderleistung im Regenerationsbetrieb	m ³ /h	15	35	50
Schalldruckpegel LpA @ 3 m	dB(A)	12	18	20
Schalldruckpegel @ 1 m	dB(A)	21	27	29
Effizienz der Wärmerückgewinnung, max	%	92		
Wärmetauschertyp	-	Regenerativer		
Wärmetauschermaterial	-	Ceramic		
Filter	-	G3 (Option: F8)		
Fördermitteltemperatur max	°C	40		
Fördermitteltemperatur min	°C	-15		
Ambientlufttemperatur, min	°C	1		
Ambientlufttemperatur, max	°C	40		
Umgebungsluftfeuchtigkeit, max	%	65		

Abmessungen

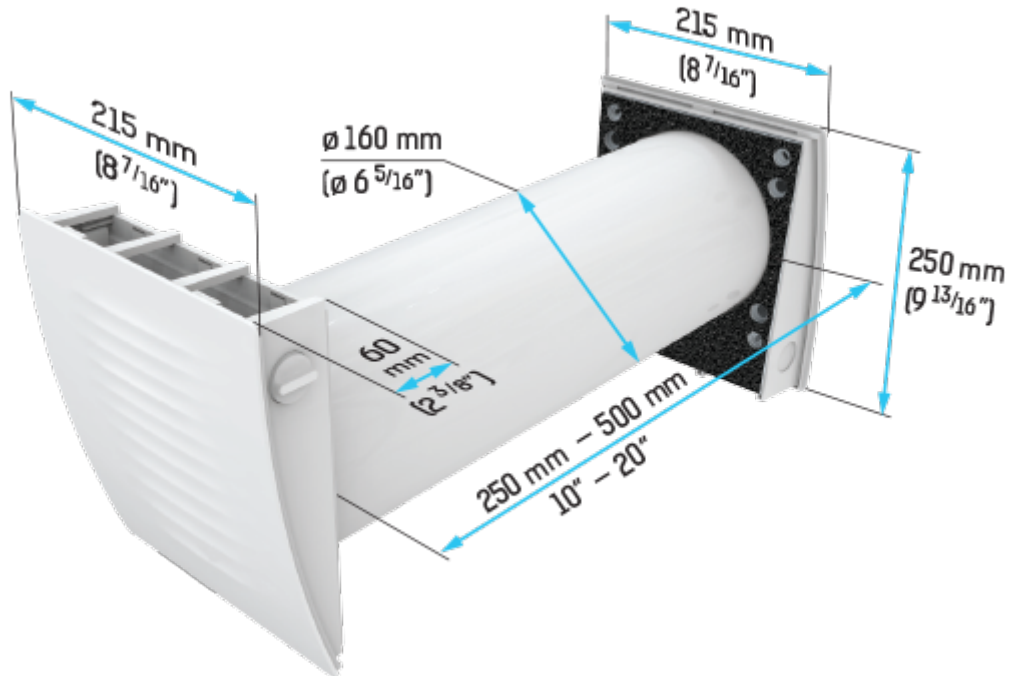



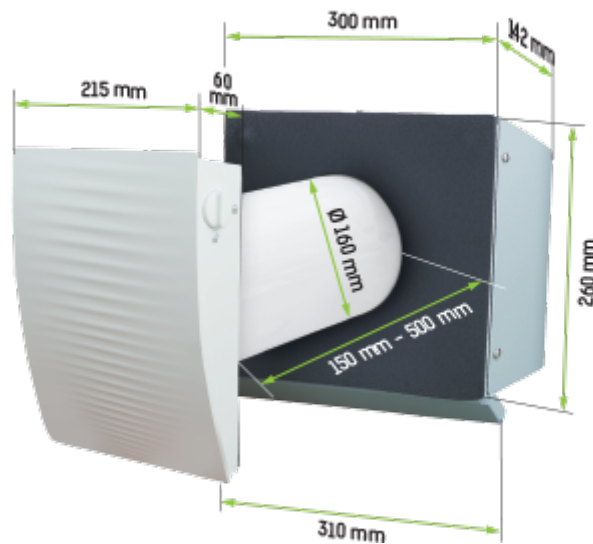









mit einer Haube für dünne Wände



Zubehör

Sonstiges Zubehör

Produktname	Foto	Beschreibung
SF TwinFresh Easy R-50 F8		F8 Filter















SF TwinFresh Easy R-50 G3		Filtersatz G3 (2 Stk.)
RK TwinFresh Easy RL-50		Fernsteuerung
KV TwinFresh Easy RL-50		LCD-Bedienfeld
EH-2 grey 160		Lüftungshaube für dünne Wände
EH-2 chrome 160		Lüftungshaube für dünne Wände
NP white 160		Winkelmontagesatz
NP chrome 160		Winkelmontagesatz
Duct 160-500		Lüftungsrohr
Duct 160-700		Lüftungsrohr
S3 TwinFresh		Patrone für kalte Klimazonen
EH-13 white 160		Lüftungshaube für kalte Klimazonen
EH-13 chrome 160		Lüftungshaube für kalte Klimazonen

Metallrohre

Produktname	Foto	Beschreibung
MVMO 150 bV1s An		Runde Metallgitter für Be- und Entlüftung

Kunststoff

Produktname	Foto	Beschreibung
-------------	------	--------------

MVVM 162 05		Außenlüftungshaube
EH-14 white 160		Kunststoff- Lüftungshaube
EH-14 chrome 160		Kunststoff- Lüftungshaube
EH-14 brown 160		Kunststoff- Lüftungshaube
EH-14 black 160		Kunststoff- Lüftungshaube
EH-14 grey 160		Kunststoff- Lüftungshaube
EH-14 beige 160		Kunststoff- Lüftungshaube
EH-14 terracotta 160		Kunststoff- Lüftungshaube
EH-17 white 160		Kunststoff- Lüftungshaube
EH-17 brown 160		Kunststoff- Lüftungshaube
EH-17 black 160		Kunststoff- Lüftungshaube
EH-17 grey 160		Kunststoff- Lüftungshaube
EH-17 beige 160		Kunststoff- Lüftungshaube
EH-17 terracotta 160		Kunststoff- Lüftungshaube