

Series
OKF



Series
OKF1



■ **Applications**

Direct-expansion duct coolers are designed for cooling of supply air in rectangular ventilation systems and can be used either for supply or supply and exhaust units.

■ **Design**

The DX coolers are available in OKF and OKF1 modifications. The OKF1 cooler has a simplified design. The cooler casing is made of galvanized steel, the piping is made of copper tubes and the heat exchange surface is made of aluminium plates. The coolers are available in 3 rows modification and designed for operation with R123, R134a, R152a, R404a, R407c, R410a, R507, R12, R22 cooling agents. It is equipped with a droplet separator and a drain pan for condensate collection and removal.

For OKF and OKF1 models by default the service side is located on the right side from the air stream direction.

The OKF cooler service side location can be changed by coil turning by 180°. The OKF1 modification does not have this option.

■ **Mounting**

▶ Mounting is effected by means of flange connection. Direct-expansion cooling coils, can be installed horizontally only to enable the condensate draining.

▶ Installation shall be performed in such a way as to provide the uniform air stream distribution along the entire cross section.

▶ The air filter shall be installed at the cooler inlet to ensure the cooler protection against dirt and dusting.

▶ The cooler can be installed at the fan inlet or outlet. If the cooler is located at the fan outlet the air duct between the cooler and the fan shall be at least 1-1.5 m long to ensure the air stream stabilization.

▶ To attain the maximum cooling capacity the cooler must be connected on counter-flow basis. All the nomographic charts in the catalogue are valid for such connection.

▶ The droplet separator is made of polypropylene profile and prevents condensate dripping from the cooling tubes by the cooling air flow. While selecting a cooler type consider that the most suitable speed of the air flow for the efficient droplet separator operation is up to 4 m/s.

▶ Condensate draining from the cooler shall be performed through the U-trap. The U-trap height depends on the total pressure in the fan. The trap height can be calculated using the figure and the table below.

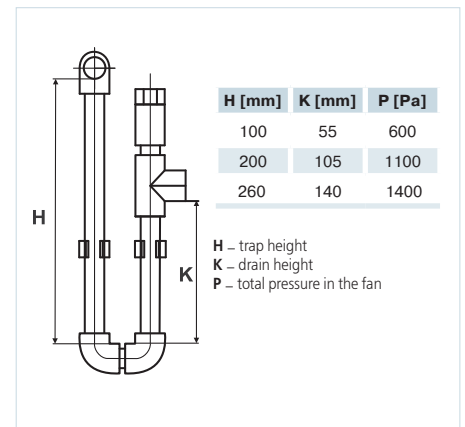

▶ To ensure the correct and safe cooler operation use the automation system providing the complex control and automatic regulation of the cooling capacity and air cooling temperature.

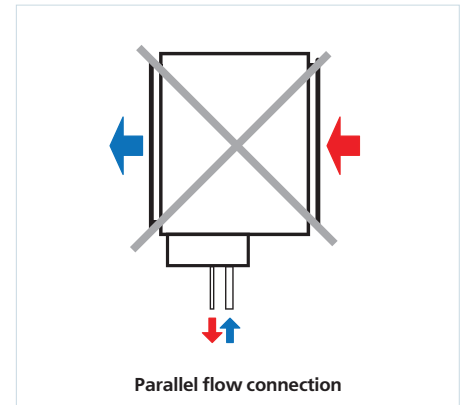
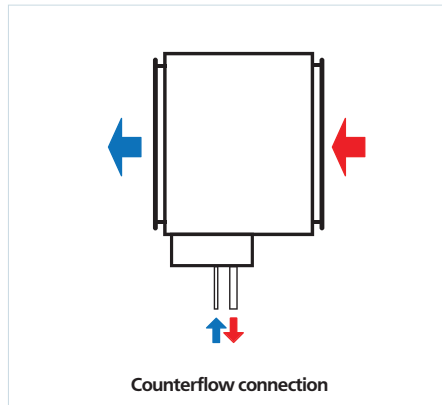

Designation key:

Series	Flange dimensions (WxH) [mm]	-	Number of cooling coils
OKF / OKF1	400x200; 500x250; 500x300; 600x300; 600x350; 700x400; 800x500; 900x500; 1000x500		3

Overall dimensions:

Type	Dimensions [mm]											
	B	B1	B2	B3	H	H1	H2	H3	H4	L	D1	D2
OKF 400x200-3	400	420	440	470	200	220	240	295	103	44	12	22
OKF 500x250-3	500	520	540	570	250	270	290	345	155	44	12	22
OKF 500x300-3	500	520	540	570	300	320	340	395	210	33	12	22
OKF 600x300-3	600	620	640	670	300	320	340	395	199	44	18	28
OKF 600x350-3	600	620	640	670	350	370	390	445	199	44	18	28
OKF 700x400-3	700	720	740	770	400	420	440	495	224	44	22	28
OKF 800x500-3	800	820	840	870	500	520	540	595	340	44	22	28
OKF 900x500-3	900	920	940	970	500	520	540	595	340	44	22	28
OKF 1000x500-3	1000	1020	1040	1070	500	520	540	595	325	44	22	28

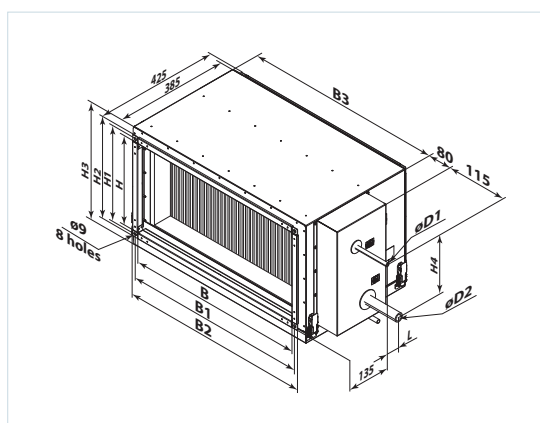

Overall dimensions:

Type	Dimensions [mm]										
	B	B1	B2	H	H1	H2	H3	L	D1	D2	
OKF1 400x200-3	400	420	580	200	220	270	103	44	12	22	
OKF1 500x250-3	500	520	680	250	270	320	155	44	12	22	
OKF1 500x300-3	500	520	680	300	320	370	210	33	12	22	
OKF1 600x300-3	600	620	780	300	320	370	199	44	18	28	
OKF1 600x350-3	600	620	780	350	370	420	199	44	18	28	
OKF1 700x400-3	700	720	880	400	420	470	224	44	22	28	
OKF1 800x500-3	800	820	980	500	520	570	340	44	22	28	
OKF1 900x500-3	900	920	1080	500	520	570	340	44	22	28	
OKF1 1000x500-3	1000	1020	1180	500	520	570	325	44	22	28	

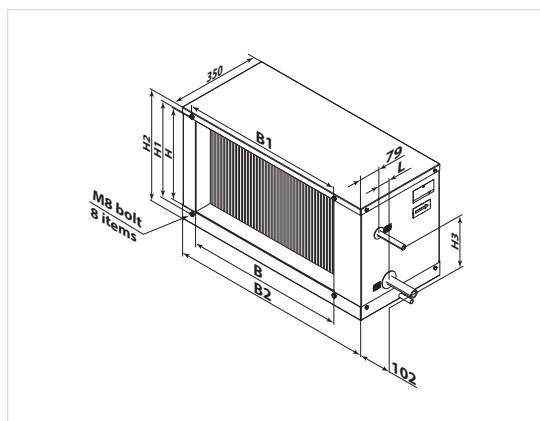

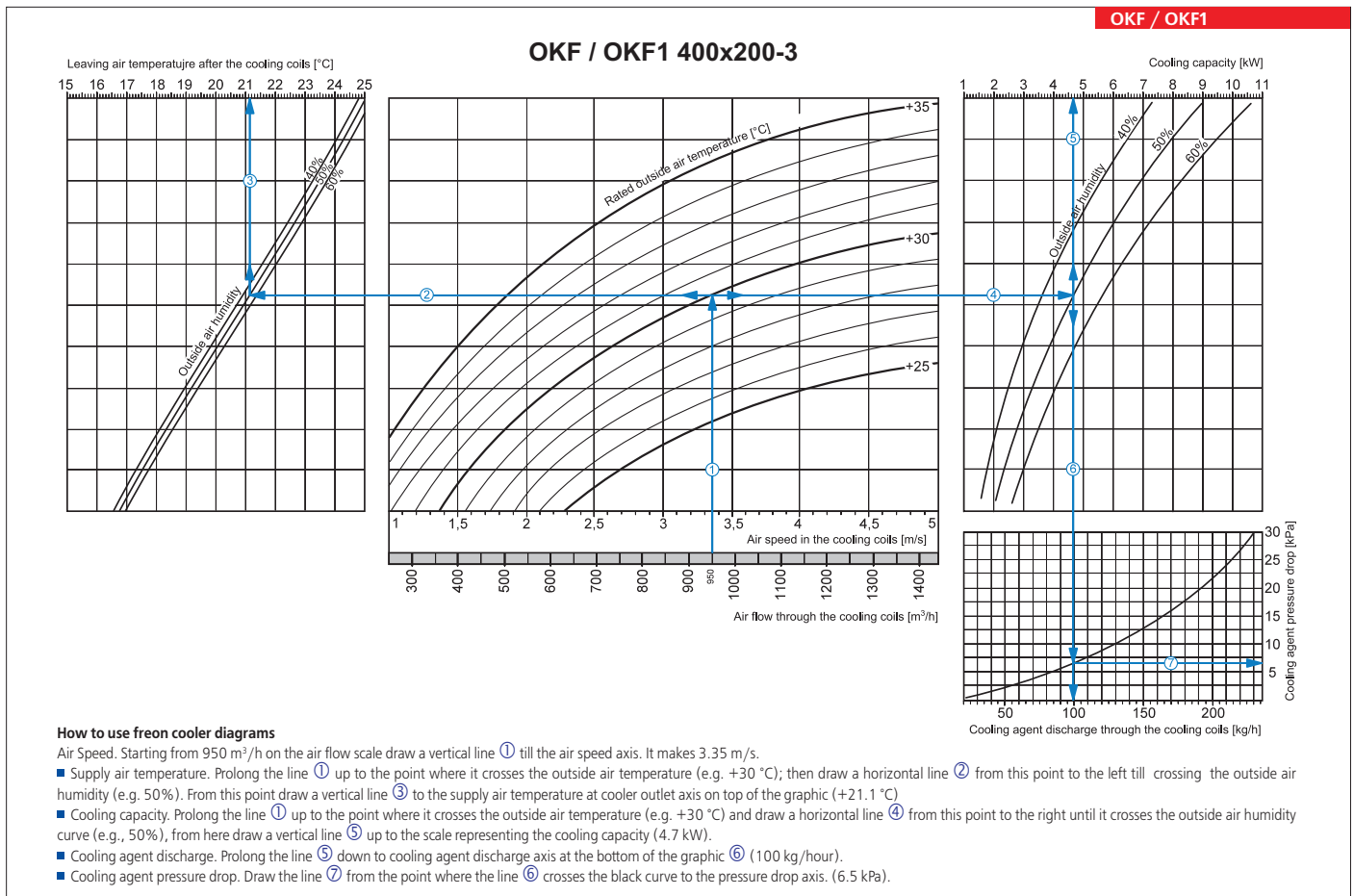
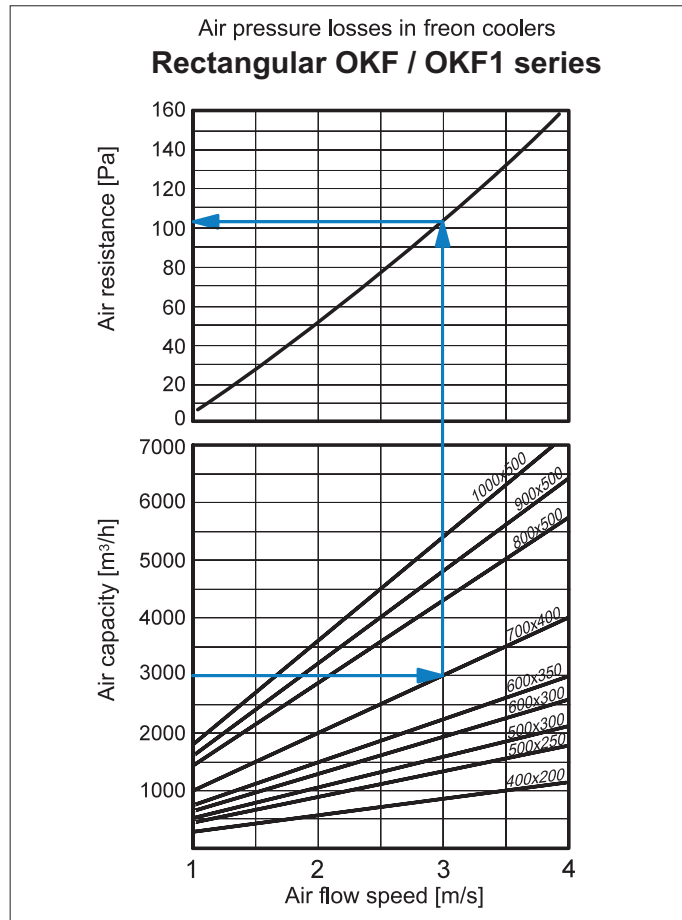

OKF / OKF1

OKF / OKF1 500x250-3

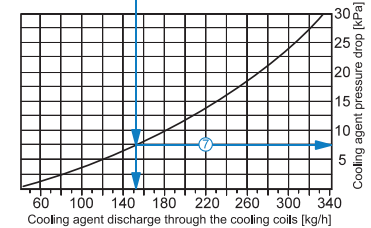
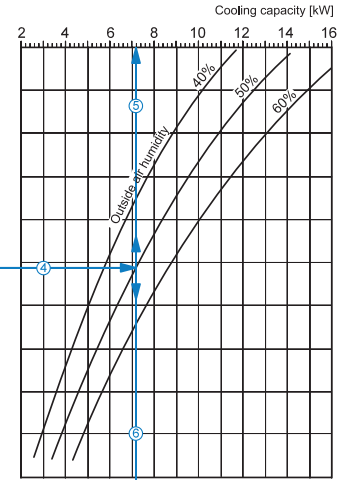
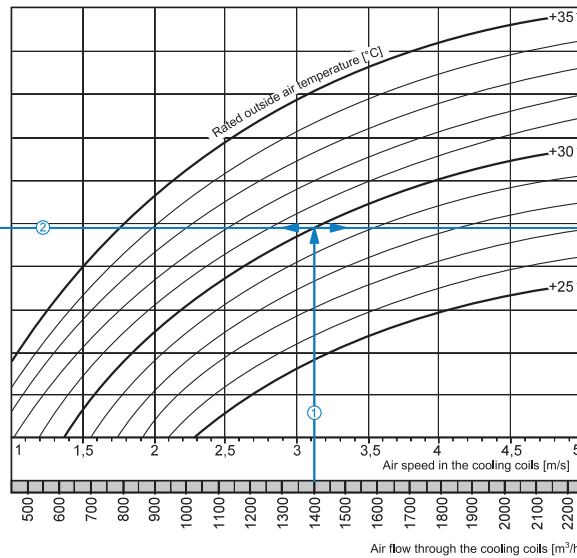
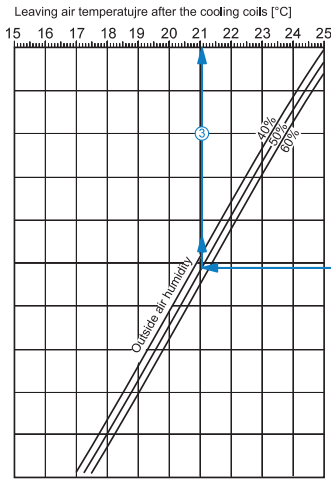

How to use freon cooler diagrams

Air Speed. Starting from 1400 m³/h on the air flow scale draw a vertical line ① till the air speed axis. It makes 3.1 m/s.

Supply air temperature. Prolong the line ① up to the point where it crosses the outside air temperature (e.g. +30 °C); then draw a horizontal line ② from this point to the left till crossing the outside air humidity (e.g. 50%). From this point draw a vertical line ③ to the supply air temperature at cooler outlet axis on top of the graphic (+21.1 °C).

Cooling capacity. Prolong the line ① up to the point where it crosses the outside air temperature (e.g. +30 °C) and draw a horizontal line ④ from this point to the right until it crosses the outside air humidity curve (e.g., 50%), from here draw a vertical line ⑤ up to the scale representing the cooling capacity (7.2 kW).

Cooling agent discharge. Prolong the line ⑤ down to cooling agent discharge axis at the bottom of the graphic ⑥ (152 kg/hour).

Cooling agent pressure drop. Draw the line ⑦ from the point where the line ⑥ crosses the black curve to the pressure drop axis. (7.5 kPa).

OKF / OKF1

OKF / OKF1 500x300-3

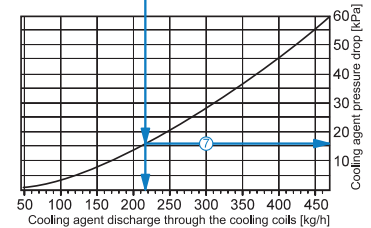
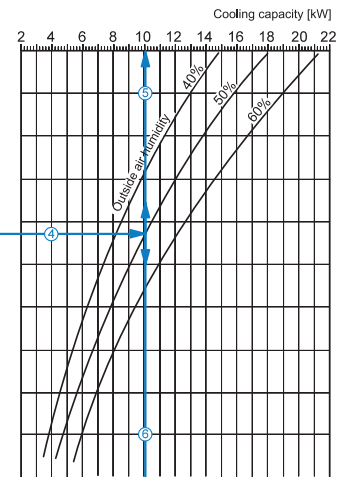
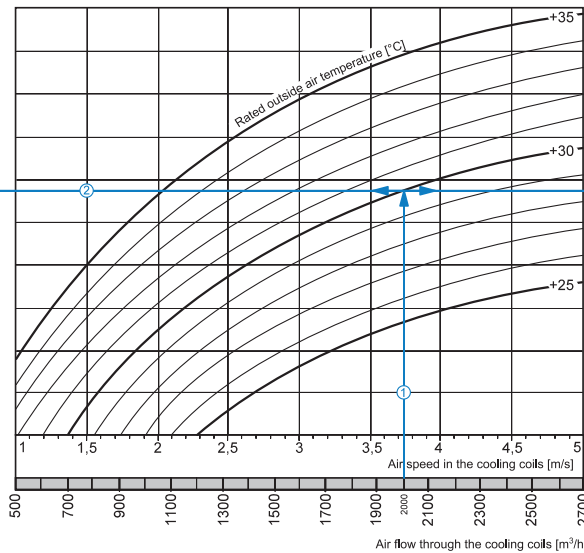
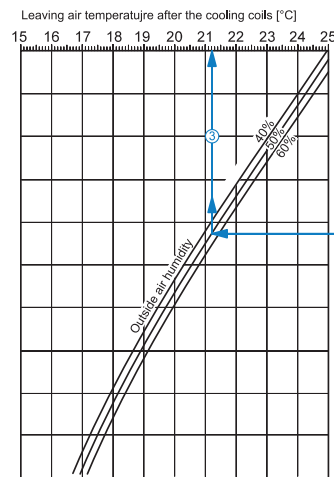

How to use freon cooler diagrams

Air Speed. Starting from 2000 m³/h on the air flow scale draw a vertical line ① till the air speed axis. It makes 3.75 m/s.

Supply air temperature. Prolong the line ① up to the point where it crosses the outside air temperature (e.g. +30 °C); then draw a horizontal line ② from this point to the left till crossing the outside air humidity (e.g. 50%). From this point draw a vertical line ③ to the supply air temperature at cooler outlet axis on top of the graphic (+21.2 °C).

Cooling capacity. Prolong the line ① up to the point where it crosses the outside air temperature (e.g. +30 °C) and draw a horizontal line ④ from this point to the right until it crosses the outside air humidity curve (e.g., 50%), from here draw a vertical line ⑤ up to the scale representing the cooling capacity (10 kW).

Cooling agent discharge. Prolong the line ⑤ down to cooling agent discharge axis at the bottom of the graphic ⑥ (215 kg/hour).

Cooling agent pressure drop. Draw the line ⑦ from the point where the line ⑥ crosses the black curve to the pressure drop axis. (16.0 kPa).

OKF / OKF1 600x300-3

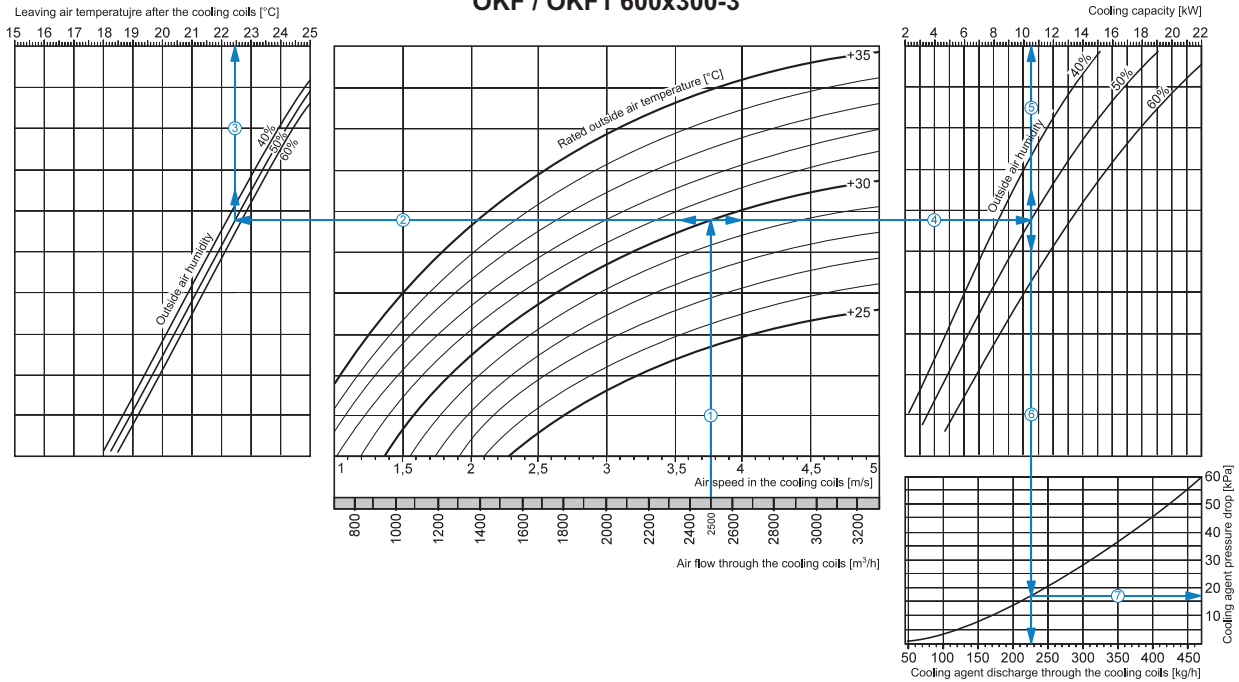

How to use freon cooler diagrams

- Air Speed. Starting from 2500 m³/h on the air flow scale draw a vertical line ① till the air speed axis. It makes 3.75 m/s.
- Supply air temperature. Prolong the line ① up to the point where it crosses the outside air temperature (e.g. +30 °C); then draw a horizontal line ② from this point to the left till crossing the outside air humidity (e.g. 50%). From this point draw a vertical line ③ to the supply air temperature at cooler outlet axis on top of the graphic (+22.5 °C).
- Cooling coil capacity. Prolong the line ① up to the point where it crosses the outside air temperature (e.g. +30 °C) and draw a horizontal line ④ from this point to the right until it crosses the outside air humidity curve (e.g., 50%), from here draw a vertical line ⑤ up to the scale representing the cooling capacity (10.5 kW).
- Cooling agent discharge. Prolong the line ⑤ down to cooling agent discharge axis at the bottom of the graphic ⑥ (225 kg/hour).
- Cooling agent pressure drop. Draw the line ⑦ from the point where the line ⑥ crosses the black curve to the pressure drop axis. (17.0 kPa).

OKF / OKF1 600x350-3

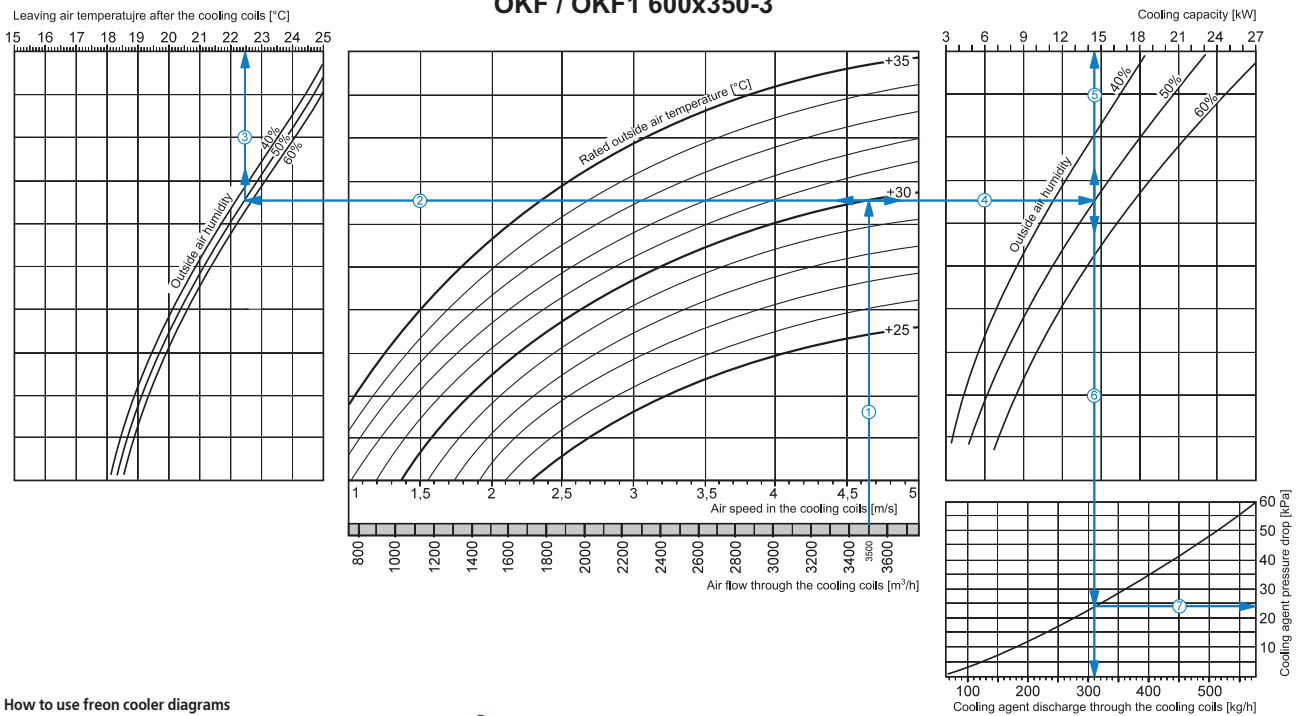

How to use freon cooler diagrams

- Air Speed. Starting from 3500 m³/h on the air flow scale draw a vertical line ① till the air speed axis. It makes 4.65 m/s.
- Supply air temperature. Prolong the line ① up to the point where it crosses the outside air temperature (e.g. +30 °C); then draw a horizontal line ② from this point to the left till crossing the outside air humidity (e.g. 50%). From this point draw a vertical line ③ to the supply air temperature at cooler outlet axis on top of the graphic (+22.5 °C).
- Cooling coil capacity. Prolong the line ① up to the point where it crosses the outside air temperature (e.g. +30 °C) and draw a horizontal line ④ from this point to the right until it crosses the outside air humidity curve (e.g., 50%), from here draw a vertical line ⑤ up to the scale representing the cooling capacity (14.5 kW).
- Cooling agent discharge. Prolong the line ⑤ down to cooling agent discharge axis at the bottom of the graphic ⑥ (310 kg/hour).
- Cooling agent pressure drop. Draw the line ⑦ from the point where the line ⑥ crosses the black curve to the pressure drop axis. (24.0 kPa).

OKF / OKF1

OKF / OKF1 700x400-3

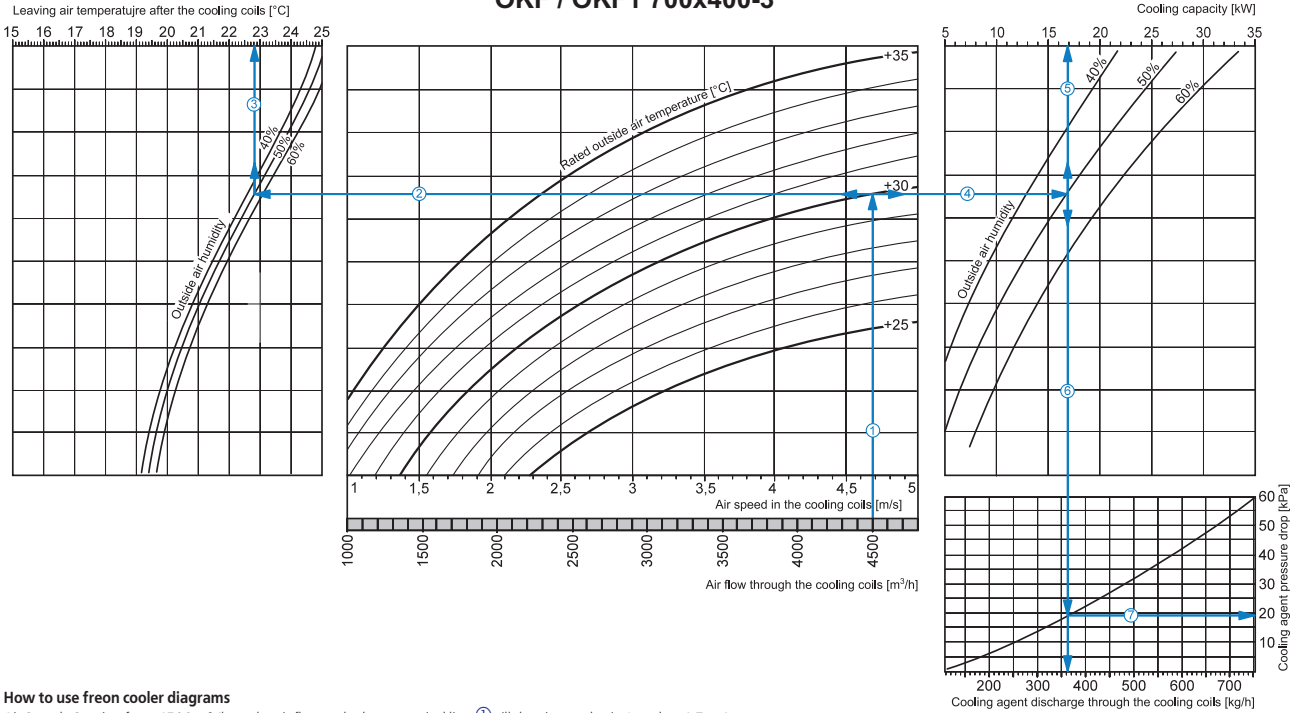

How to use freon cooler diagrams

- Air Speed. Starting from 4500 m³/h on the air flow scale draw a vertical line ① till the air speed axis. It makes 4.7 m/s.
- Supply air temperature. Prolong the line ① up to the point where it crosses the outside air temperature (e.g. +30 °C); then draw a horizontal line ② from this point to the left till crossing the outside air humidity (e.g. 50%). From this point draw a vertical line ③ to the supply air temperature at cooler outlet axis on top of the graphic (+22.8 °C).
- Cooling coil capacity. Prolong the line ① up to the point where it crosses the outside air temperature (e.g. +30 °C) and draw a horizontal line ④ from this point to the right until it crosses the outside air humidity curve (e.g., 50%), from here draw a vertical line ⑤ up to the scale representing the cooling capacity (17.0 kW).
- Cooling agent discharge. Prolong the line ⑤ down to cooling agent discharge axis at the bottom of the graphic ⑥ (360 kg/hour).
- Cooling agent pressure drop. Draw the line ⑦ from the point where the line ⑥ crosses the black curve to the pressure drop axis. (19.0 kPa).

OKF / OKF1

OKF / OKF1 800x500-3

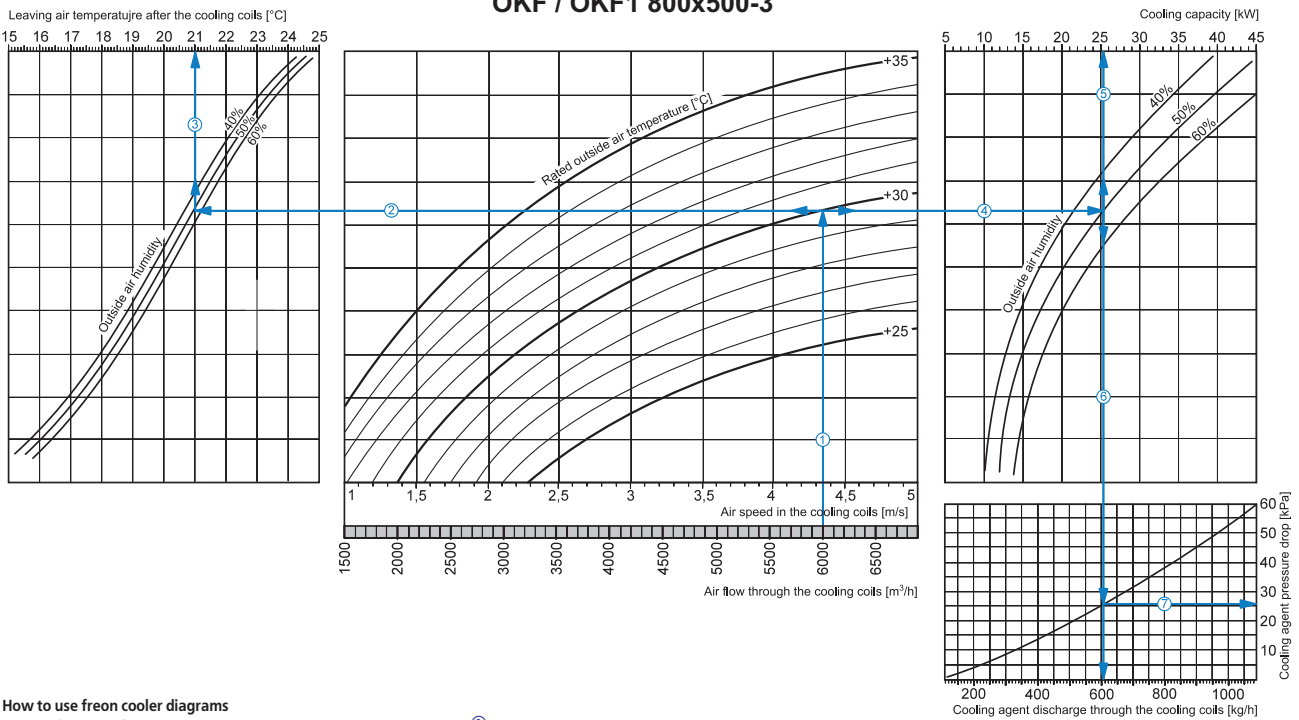

How to use freon cooler diagrams

- Air Speed. Starting from 6000 m³/h on the air flow scale draw a vertical line ① till the air speed axis. It makes 4.35 m/s.
- Supply air temperature. Prolong the line ① up to the point where it crosses the outside air temperature (e.g. +30 °C); then draw a horizontal line ② from this point to the left till crossing the outside air humidity (e.g. 50%). From this point draw a vertical line ③ to the supply air temperature at cooler outlet axis on top of the graphic (+21.0 °C).
- Cooling coil capacity. Prolong the line ① up to the point where it crosses the outside air temperature (e.g. +30 °C) and draw a horizontal line ④ from this point to the right until it crosses the outside air humidity curve (e.g., 50%), from here draw a vertical line ⑤ up to the scale representing the cooling capacity (25.5 kW).
- Cooling agent discharge. Prolong the line ⑤ down to cooling agent discharge axis at the bottom of the graphic ⑥ (605 kg/hour).
- Cooling agent pressure drop. Draw the line ⑦ from the point where the line ⑥ crosses the black curve to the pressure drop axis. (26.0 kPa).

OKF / OKF1 900x500-3

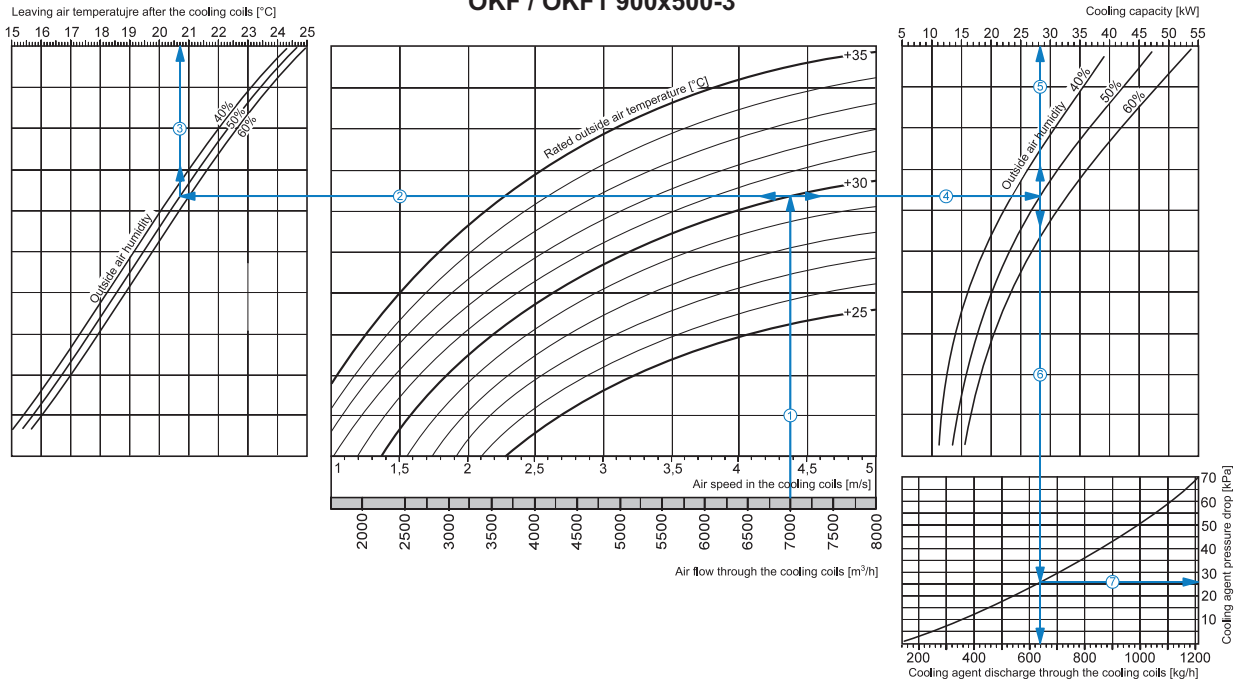

How to use freon cooler diagrams

Air Speed. Starting from 7000 m³/h on the air flow scale draw a vertical line ① till the air speed axis. It makes 4.4 m/s.

Supply air temperature. Prolong the line ① up to the point where it crosses the outside air temperature (e.g. +30 °C); then draw a horizontal line ② from this point to the left till crossing the outside air humidity (e.g. 50%). From this point draw a vertical line ③ to the supply air temperature at cooler outlet axis on top of the graphic (+20.7 °C).

Cooling coil capacity. Prolong the line ① up to the point where it crosses the outside air temperature (e.g. +30 °C) and draw a horizontal line ④ from this point to the right until it crosses the outside air humidity curve (e.g., 50%), from here draw a vertical line ⑤ up to the scale representing the cooling capacity (28.0 kW).

Cooling agent discharge. Prolong the line ⑤ down to cooling agent discharge axis at the bottom of the graphic ⑥ (640 kg/hour).

Cooling agent pressure drop. Draw the line ⑦ from the point where the line ⑥ crosses the black curve to the pressure drop axis. (26.0 kPa).

OKF / OKF1

OKF / OKF1 1000x500-3

Leaving air temperature after the cooling coils [°C]

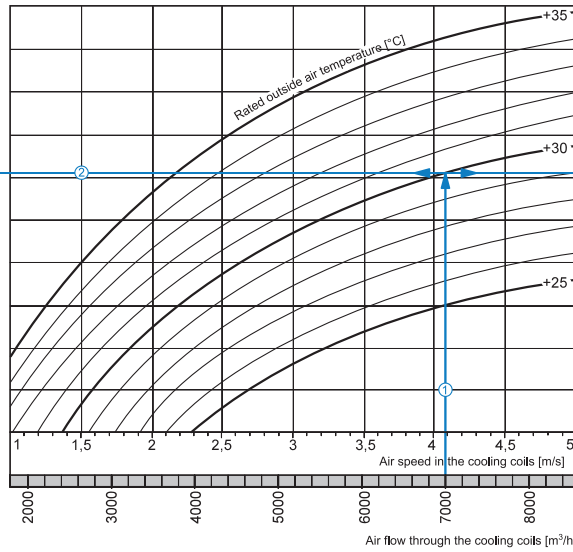
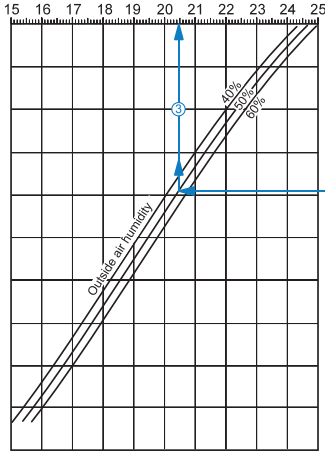

Cooling capacity [kW]

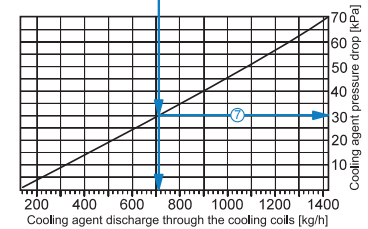
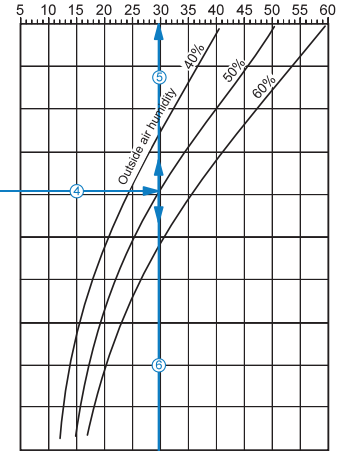

How to use freon cooler diagrams

Air Speed. Starting from 7000 m³/h on the air flow scale draw a vertical line ① till the air speed axis. It makes 4.1 m/s.

- Supply air temperature. Prolong the line ① up to the point where it crosses the outside air temperature (e.g. +30 °C); then draw a horizontal line ② from this point to the left till crossing the outside air humidity (e.g. 50%). From this point draw a vertical line ③ to the supply air temperature at cooler outlet axis on top of the graphic (+20.5 °C).
- Cooling coil capacity. Prolong the line ① up to the point where it crosses the outside air temperature (e.g. +30 °C) and draw a horizontal line ④ from this point to the right until it crosses the outside air humidity curve (e.g., 50%), from here draw a vertical line ⑤ up to the scale representing the cooling capacity (30.0 kW).
- Cooling agent discharge. Prolong the line ⑤ down to cooling agent discharge axis at the bottom of the graphic ⑥ (710 kg/hour).
- Cooling agent pressure drop. Draw the line ⑦ from the point where the line ⑥ crosses the black curve to the pressure drop axis. (30.0 kPa).