

2023

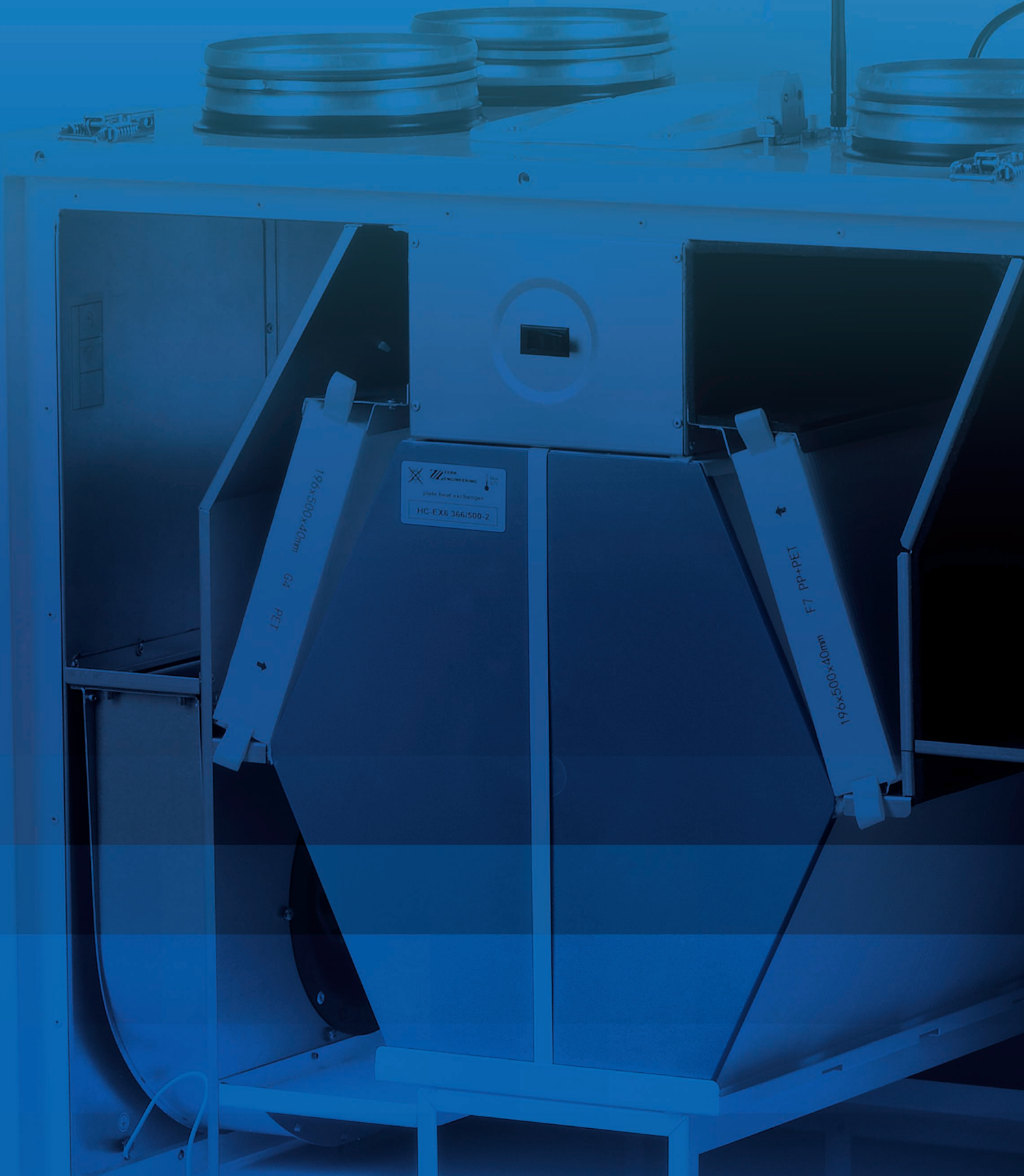

AIR HANDLING UNITS



AIR HANDLING UNITS WITH HEAT RECOVERY

COMPACT HEAT RECOVERY AIR HANDLING UNITS



VENTS VUT 100 P mini/VENTS VUE 100 P mini
Air handling units with heat recovery

Air flow – up to 100 m³/h

page
16



VENTS VUT/VUE 250 V mini/VUT/VUE 250 H mini
Air handling units with heat recovery

Air flow – up to 250 m³/h

page
18



VENTS VUT V2/H2 mini EC, VENTS VUE V2/H2 mini EC
Air handling unit with heat recovery and EC motor

Air flow – up to 350 m³/h

page
20

HEAT RECOVERY AIR HANDLING UNITS IN EPP CASING



VENTS VUE P3
Air handling units with heat recovery

Air flow – up to 400 m³/h

page
22



VENTS VUE P3B EC
Air handling units with heat recovery

Air flow – up to 400 m³/h

page
26



VENTS VUT/VUE 180 P5B EC
Air handling units with heat recovery

Air flow – up to 220 m³/h

page
30



VENTS VUT/VUE 270 V5B EC
Air handling unit with heat recovery and EC motor

Air flow – up to 300 m³/h

page
34



AIR HANDLING UNIT WITH HEAT RECOVERY AND EC MOTOR



VENTS VUT PB EC
Air handling unit with heat recovery and EC motor

Air flow – up to 410 m³/h

page
38



VENTS VUT VB EC/VENTS VUE VB EC
Air handling unit with heat recovery and EC motor

Air flow – up to 690 m³/h

page
44



VENTS VUT/VUE HB EC/VENTS VUT/VUE HBE EC
Air handling units with heat recovery

Air flow – up to 830 m³/h

page
54



VENTS VUT PBE EC/VENTS VUT PBW EC
Air handling unit with heat recovery and EC motor

Air flow – up to 4300 m³/h

page
62

VENTILATION UNITS WITH HEAT RECOVERY



VENTS VUT H
Air handling units with heat recovery

Air flow – up to 2200 m³/h

page
72



VENTS VUT EH/VENTS VUT WH
Air handling units with heat recovery

Air flow – up to 2200 m³/h

page
76

AIR HANDLING UNITS WITH ROTARY HEAT EXCHANGER

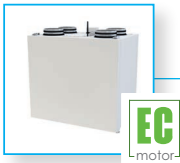

VENTS VUTR VE EC
Air handling unit with heat recovery and EC motor

Air flow – up to 670 m³/h

page
84



VENTS VUTR PE EC
Air handling unit with heat recovery and EC motor

Air flow – up to 710 m³/h

page
90



VUTR EH EC/VUTR WH EC
Air handling unit with heat recovery and EC motor

Air flow – up to 2250 m³/h

page
98



VENTS VUTR 200 V6E EC
Air handling unit with heat recovery and EC motor

Air flow – up to 270 m³/h

page
106

SUPPLY UNITS, EXHAUST UNITS



VENTS VPA series supply units

Air flow – up to 1520 m³/h

page
110



VENTS MPA...E series supply units

Air flow – up to 3500 m³/h

page
114



VENTS MPA...W series supply units

Air flow – up to 6500 m³/h

page
114



VENTS PA...E series supply units

Air flow – up to 3350 m³/h

page
124







VENTS PA...W series supply units

Air flow – up to 4100 m³/h

page
124

ACCESSORIES

	<p>Silencers</p> <p>SR, SRF, SRP, SRN</p>	<p>page</p> <p>132</p>
	<p>Heaters</p> <p>NKP, NKP A21 V.2, NKD, NKD A21 V.2</p>	<p>page</p> <p>140</p>
	<p>Coolers</p> <p>OKW, OKW1, OKF, OKF1</p>	<p>page</p> <p>154</p>
	<p>Mixing units</p> <p>USWK</p>	<p>page</p> <p>170</p>
	<p>Hydraulic U-trap</p> <p>SH-32</p>	<p>page</p> <p>172</p>
	<p>Dampers</p> <p>DN-2</p>	<p>page</p> <p>173</p>
	<p>Dampers</p> <p>KOM, KOMu, KOM1</p>	<p>page</p> <p>174</p>
	<p>Air dampers</p> <p>KR, KRV</p>	<p>page</p> <p>177</p>
	<p>Air flow controllers</p> <p>RRV</p>	<p>page</p> <p>180</p>
	<p>Flexible connectors</p> <p>VVG, VVGF</p>	<p>page</p> <p>182</p>
	<p>Control panels</p> <p>A22, A22 Wi-Fi, A25</p>	<p>page</p> <p>184</p>

ACCESSORIES



Electro-mechanical humidistats
HR-S

page
186



Electric actuator BELIMO
TF230/TF24

page
187



Humidity sensor
DPWC1120

page
188



VOC sensor
DPWQ30600

page
189



CO₂ sensors
DPWQ40200, CO2-1, CO2-2

page
192



Kitchen exhaust hood
KH-1

page
194

WELCOME TO THE WORLD OF VENTS!



- The company's product range includes over 50,000 items
- Over the years the company has produced 100 million fans
- The production facilities spread across 150,000 square meters of territory
- The company employs more than 3,500 professionals involved in the entire life cycle of creating ventilation equipment – from concept to high-tech product
- Among other assets the facilities include the climatic equipment research and development centre and a suite of state-of-the-art laboratories manned by 200 engineers
- The company utilises the latest metal and polymer processing technology
- 99 % of our products are made in-house
- We are the only company in the industry which develops and builds 85 % of its ventilation equipment components

Being the world's ventilation leader VENTS offers a wide range of cutting-edge ventilation equipment to satisfy most demanding customers. Since the inception, the company's products have become popular in more than 100 countries worldwide while the VENTS brand has earned a solid reputation for quality, reliability and innovation. Every tenth domestic fan in the world rolled off the assembly line of the VENTS factory. Every time you buy a product carrying the VENTS

brand you can be confident that you have made the right choice. Thanks to a comprehensive range of ventilation equipment for home, commercial and industrial applications you can always find the necessary equipment and components to suit your needs. The climatic engineering and design solutions department is tasked with developing bespoke ventilation and air conditioning systems for even the most challenging projects.

Technology of the future

The VENTS factory is not just about state-of-the-art production lines equipped with processing machines from the leading global suppliers. Today this is a full-on research and development facility spreading across 150,000 square metres of territory which includes a climatic equipment research and development centre and a comprehensive suite of state-of-the-art laboratories.

The full-time staff of more than 200 engineers are continuously seeking to improve the VENTS products. The company utilises cutting-edge metal and polymer processing technology manufacturing 99 % of its products in-house.

We are the only company in the industry which develops and builds 85 % of its ventilation equipment components including electric motors, heat exchangers as well as control and automation equipment.



Getting better every day

The world of today is nothing but stable or permanent. Each day the market comes up with new expectations with regards to ventilation equipment quality and performance. Therefore, VENTS places a strong emphasis on constant development and improvement.

To this end the company has adopted a policy which includes continuous upgrades to its process equipment fleet, implementing the latest in manufacturing technology, and holding regular training workshops for its staff. Not only does this help us keep abreast with the times – these efforts help us to exceed our customers' expectations.



Uncompromising quality

VENTS maintains a stringent quality control system to make sure that its products always meet most demanding international standards as confirmed by numerous certificates issued by the world's largest and most reputable organisations for quality control. The VENTS production process is certified according to ISO 9001:2015 international

standard for quality management systems of organizations and enterprises. The company operates in accordance with all the applicable environmental standards and continuously implements new technology in order to ensure compliance with the latest environmental regulations.

Energy efficiency and energy saving

Energy resources are finite and costly. This is why energy-saving is among the company's top priorities. We pay a special attention to using heat and electricity in the most efficient manner which helps us reduce the environmental footprint of the manufacturing process and develop

more competitive products. The outstanding energy efficiency and low power consumption of our ventilation equipment are achieved by using high-performance EC motors and heat exchangers.

Human resources: a valuable asset



Besides maintaining technical leadership and developing new technology the company also values the people that it owes its success to.

Today VENTS employs more than 3,500 professionals involved in the entire life cycle of ventilation equipment creation – from concept to high-tech product. The company strives to create a comfortable working environment for its employees to maximise their performance and encourage their professional and personal development.

Responsible corporate citizen



Being a responsible corporate citizen VENTS takes an active part in various academic and charity initiatives. The company has a long history of cooperation with a number of educational establishments extending its support to talented youth.

The company takes an active part in student competitions and workshops sharing its wealth of practical knowledge and providing access to state-of-the-art ventilation equipment. The company employees participate in a range of charitable events and sporting competitions on a regular basis.

Following the customer's lead

VENTS uses its extensive research and technical capabilities to develop bespoke ventilation products and solutions for its customers from around the world.

Our products have earned a reputation for reliability being used in polar regions and in the Sahara desert, in the jungle of South-Eastern Asia and in the Pamir mountains.

Wherever our customers are they can always depend on prompt delivery thanks to our worldwide network of strategically located logistics centres.

The company's newest arrivals are presented by its engineers at numerous international exhibitions every year.



Welcome to the world of modern ventilation by VENTS!

VENTILATION IN OUR LIFE



▶ What Is Ventilation?

Ventilation is a set of actions and techniques used to arrange air exchange and to provide a specific air medium condition in the premises and in working places. Ventilation maintains desirable indoor climatic parameters in compliance with set hygienic norms and technology requirements.

▶ What Is Ventilation Required For?

We are surrounded with air and breathe in and out 20 000 litres of air every day. How much healthy is the air we breathe in? There is a range of aspects to determine air quality.

- ▶ **Oxygen and carbon dioxide concentration in the air.** Oxygen decrease and carbon dioxide cause stuffiness in the premises.
- ▶ **Concentration of harmful substances and dust in the air.** High concentration of dust, tobacco smoke and other substances in the air is harmful for health and can cause various lung and skin diseases.
- ▶ **Odours.** Bad smell causes discomfort and irritates.
- ▶ **Air humidity.** Too high or low humidity makes us feel uncomfortable and even may provoke acute conditions. Air humidity is important also for inner climate. For instance, doors, window frames, furniture may shrink because of too low humidity in winter and get swollen in humid environments, e.g. in swimming-pools, bathrooms.
- ▶ **Air temperature.** The comfortable indoor temperature is within 21-23 °C. Higher or lower temperatures influence physical and mental activity and health condition.
- ▶ **Air motion.** Increased air motion in the premises causes drafts and low air motion causes air blanketing. Any of these factors influence our well-being.

▶ Ventilation system arrangement

Properly arranged ventilation system is the only solution in this situation. It provides supply of filtered air in summer and supply of filtered and warmed up air in winter as well as extract stale air removal from the premises.

Any ventilation system must include synchronous fresh air supply and extract air exhaust thus ensuring the ideal air balance in the room. In case of poor or insufficient

air intake from outside the oxygen content decreases, humidity and dustiness level increase. If exhaust ventilation is not provided or it is not efficient, polluted air, smells, humidity and harmful substances are not removed.

One more important factor for properly arranged ventilation system is joint operation of supply and exhaust air vents. If indoor ventilation is provided by air exhaust only, e.g. by an extract bathroom fan, the only possible air supply source is the gaps in windows, doors and construction elements. This uncontrollable air supply results in dust ingress, smells and draughts.

Ventilation grilles in the bathroom doors, wall or window vents, open windows are the only natural supply air sources that may compensate for air extraction. However mechanical ventilation is the only solution to provide central air supply in the rooms.

▶ Calculation of the required air exchange.

Ventilation design recommendations

Calculation of air exchange according to air exchange rate:

Ventilation air volume is determined for each premise separately considering concentration of harmful substances. Alternatively, ventilation air volume calculated be set according to the research results. If the nature and concentration of harmful substances is not possible to determine, air exchanged is calculated as following:

$$L = V_{\text{prem.}} \cdot \text{Ach} \quad [\text{m}^3/\text{h}],$$

where **V_{prem.}** – premise volume [m³];

Ach – minimum air exchange per hour, refer air exchange table.

How to determine a premise volume?

Use a simple formula:

length x width x height = volume of the premises in cubic meters

$$A \times B \times H = V \text{ [m}^3\text{]}$$

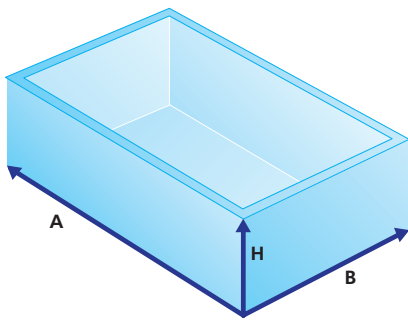

Example: a premise with 7 m length, 4 m width and 2.8 m height. To determine the air volume required for ventilation of this premises, calculate the room volume $7 \times 4 \times 2.8 = 78.4 \text{ m}^3$. After that determine the required efficiency of the fan using the following tables of recommended ventilation rate.

Calculation of air exchange according to number of inhabitants:

$$L = L_1 * N_L \text{ [m}^3\text{/hour]},$$

where L_1 – rated value for air volume per one person, $\text{m}^3/\text{h} \cdot \text{person}$;

N_L – number of inhabitants in the premises

20-25 m^3/h per one person at low physical activity

45 m^3/h per one person at light physical activity

60 m^3/h per one person at heavy physical activity

Calculation of air exchange with vapor emission:

$$L = \frac{D}{(d_v - d_n) * \rho} \text{ [m}^3\text{/hour]}$$

D : moisture, g/hour

d_v : moisture content in the exhaust air, gram of water/kg of air

d_n : moisture content in the intake air, gram of water/kg of air

ρ : air density, kg/m^3 (at $20^\circ\text{C} = 1.205 \text{ kg}/\text{m}^3$)

Calculation of air exchange to remove excessive heat:

$$L = \frac{Q}{\rho * C_p * (t_v - t_n)} \text{ [m}^3\text{/hour]}$$

Q : heat emission in the premises, kW

t_v : exhaust air temperature, $^\circ\text{C}$

t_n : intake air temperature, $^\circ\text{C}$

ρ : air density [kg/m^3] at $20^\circ\text{C} = 1.205 \text{ kg}/\text{m}^3$

C_p : heat capacity of air [$\text{kJ}/(\text{kg} \cdot \text{K})$] at 20°C ; $C_p = 1.005 \text{ kJ}/(\text{kg} \cdot \text{K})$

Air ventilation rate:

Premise	Air exchange rate	
Domestic premises	Living room of apartments or hostel residential premises	3 m^3/h for 1 m^2 in residential premises
	Kitchen in flat or hostel	6-8
	Bathroom	7-9
	Shower cabin	7-9
	WC	8-10
	Home laundry room	7
	Cloakroom	1.5
	Storeroom	1
	Garage	4-8
	Cellar	4-6
	Industrial premises and large premises	Theatre, cinema, confrence hall
Office		5-7
Bank		2-4
Restaurant		8-10
Bar, café, pub, billiard room		9-11
Professional kitchen		10-15
Supermarket		1.5-3
Chemist's		3
Garages and vehicle repair shops		6-8
Public WC		10-12 (or 100 m^3 per each WC pan)
Dance halls and disco clubs		8-10
Smoking rooms		10
Server rooms		5-10
Sport hall		80 m^3 or more for each sportsman and 20 m^3 or more for each viewer
Hair dresser's		
Up to 5 working places		2
More than 5 working places		3
Warehouses		1-2
Laundryroom		10-13
Swimming pool		10-20
Industrial painting shop	25-40	
Machine shop	3-5	
School classroom	3-8	

Calculation of air exchange depending on maximum permissible concentration of aggressive substances in the air:

$$L = \frac{G_{\text{CO}_2}}{U_{\text{PDK}} - U_p} \text{ [m}^3\text{/hour]}$$

G_{CO_2} : CO_2 release amount [l/hour]

U_{PDK} : CO_2 maximum permissible concentration, l/m^3

U_p : gas concentration in the intake air, l/hour

Automation

▶ The **VUT 300 EH EC A21** units are equipped with integrated control system. The A21 controller allows integrating the unit into the **Smart Home system** or **BMS (Building Management Systems)**.

Filter

▶ High degree of air purification is achieved due to G4-F7 incorporated panel type filters on metal frames. Filter size match the European Norms and Standards. Filter clogging control by means of integrated automation system as well as filter easy removal and cleaning ensure their quality and durability.

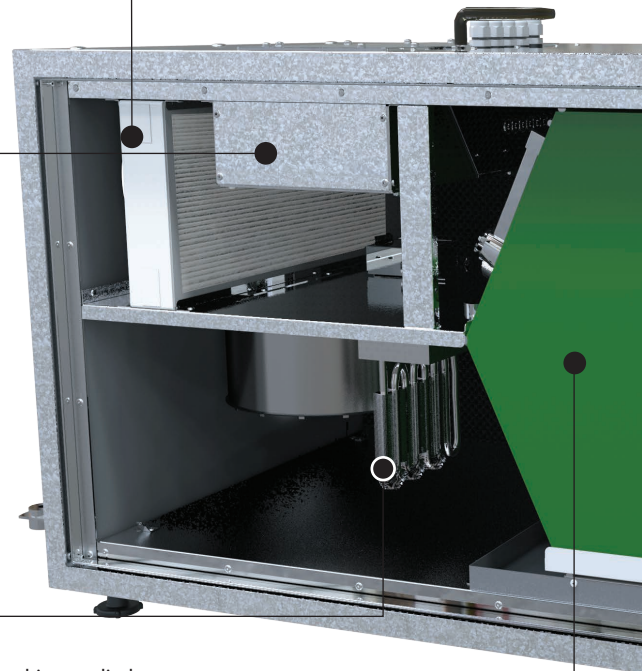
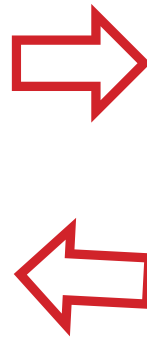

Heater:

▶ Electric heater is designed for air handling unit operation at low outside temperature and is supplied as a standard.
 ▶ Electric heater is made of heat-resisting stainless steel ribbed to increase the heat exchange surface area and equipped with two overheating protecting thermostats.

Heat exchanger (recuperator)

▶ Plate heat exchanger with a great surface area and high efficiency made of polystyrene. The extract air transfers heat to the plates and the plates transfer heat to supply air flow. The heat exchange efficiency is up to 95 % which allows reducing heating costs. The supply and extract air flows do not get mixed which ensures no contamination, odours, microbes transfer. By-pass damper provides switching to no heat recovery mode if required.

Heat recovery



Control system



Effective insulation



Photo:
VUT 300 EH EC A21

Casing

▶ The casing is made of two-layers aluminum-zinc compound internally filled with the mineral wool layer for heat and sound insulation. The internal sheet is made of aluminum-zinc steel plates with varnish coating to ensure long service life. The internal galvanized steel plate provides the surface hygienic purity of the unit and disables dirt accumulation on the panel. The side panels can be easily removed for inspection and service of all the unit elements.

Fan with EC motor:



▶ Air supply and exhaust is effected by means of two centrifugal single-inlet EC fans equipped with forward curved blades.
 ▶ EC motor is a synchronous brushless electronically commutated motor. EC motors have energy consumption by up to 50 % less as compared to standard motors of the same capacity. The operating costs for their maintenance are by 30 % less.
 ▶ Such fan design ensures minimum noise level combined with high capacity.

Anti-vibration rubber mount:

▶ Mounting the unit onto the rubber anti-vibration mounts makes its operation totally quiet and vibration-free and disables vibration transfer to buildings.

Drain pan:

▶ The unit is equipped with the drain pan of painted steel for condensate collection. Draining pipes for condensate drainage on the bottom are connected to the draining system.

Simple installation



Energy-saving EC motors

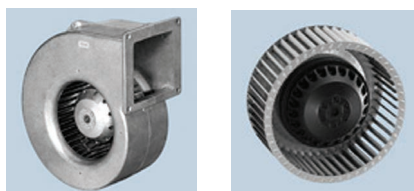

Easy maintenance

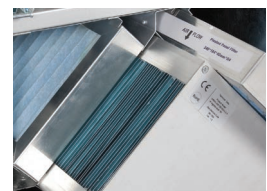

The issue of ventilation from the point of view of thermal energy saving (maintaining permanent temperature) is the most essential subject. The factors that influence the heat loss dynamics vary from wall thermal protection to heaters and heating system quality, density of wall panels joints and window joints as well as personal consumption habits.

In modern buildings ventilation demands up to 45 % of the total heat energy consumption. The reasons are as follows:

- a) One half of air volume is exchanged through the open window within 30-60 min. During this process the heat losses grow tremendously;
- b) Energy saving houses are equipped with all available facilities for sealing and thermal isolation of the buildings. Such houses are so well insulated that the heat loss through the walls makes only 30 to 40 % of the total amount.

Thus the heat losses caused by ventilation process remove 2/3 of the total heat. So we come to the point of providing air exchange with minimum heat losses. From 30 % to 70 % of heat loss is variously estimated for the traditional for residential houses exhaust ventilation. Controllable air exchange and heat recovery are the compulsory attributes in the modern construction that are ensured by means of air handling units. The forced ventilation allows recuperating up to 90 % of the exhaust air heat. Such effect is attained due to installation of the heat exchanger (recuperator).

The heat exchanger allows saving heat in winter period and contributes to better operation of air conditioners jointly with ventilation system in summer period. In addition the heat exchangers have heat- and soundinsulated casing that reduces the noise level produced by equipment in the room. As of today the ventilation systems based on heat exchangers are the most state-of-the-art and progressive solution for air exchange arranging in the premises.

Due to recuperation of the unit its owner can save good money for operation costs. Use of the ventilation units with heat recovery jointly with the air conditioning systems is not only the most effective way to arrange the required microclimate in the room but to cut costs as well. In winter the heat exchanger saves heat and in summer it saves cool.

Structure and operating principle of the plate heat exchangers

The design of the plate heat exchangers is such as to exclude the transfer of contaminants, odours and microbes from the exhaust air flow to the supply air flow as both warm (exhaust) and cold (supply) air flows are divided by wall elements of heat exchanger plates made of aluminium or polystyrene. Thermal energy quantity that is transferred from the exhaust air to the supply air depends exclusively on the thermal conductivity of the applied materials and temperature difference between two flows. Concurrently the warm exhaust air is heated and the cold supply air is cooled. Though there is no moisture exchange between the extract and supply air streams, a part of latent wet extract air energy is used for heat recovery. In case of low outside

- ▶ low energy demand;
- ▶ low investment for thermal energy generation and its distribution;
- ▶ no removable parts which means durability and long service life at continuous operation;
- ▶ high-efficient heat recovery and little investment result in high self-repayment;
- ▶ environmental protection.

The plate heat exchanger of cross-flow or counter-flow type is the simplest one and contains no movable parts and electrical connections; it separates the air streams fully; maintenance-free and requires no additional energy consumption.

Utilization of units with heat recovery in ventilation systems results in shortening of payback period and improving its ecological characteristics in view of low energy demand, low investment for heat energy generation and its distribution, careful attitude to environment.

New series of compact air handling units with EC (electronically commutated) motors provide energy consumption reducing up to 50 % as compared to traditional asynchronous motors. Operating costs will be by 30 % in general reduced.

Fans with EC motors have the following advantages:

- ▶ efficient operation at any rotation speed of fan impeller (up to zero) and significant winding electrical resistance;
- ▶ low heat generation that enables reducing performance losses of refrigeration equipment and compensate for heat generation of fan motors in case of utilization of EC motor fans in conditioning systems;
- ▶ fan overall dimensions can be reduced in case of the design with external rotor and EC motor advantages. Consequently the disadvantages related to large-scale overall dimensions that are typical for fans with standard motors are minimized;
- ▶ the maximum motor speed does not depend upon frequency (operation both at 50 Hz and 60 Hz is possible);
- ▶ high efficiency at low speed;
- ▶ design with external rotor to make it compact.

temperature and high extract air temperature the exhaust air temperature can drop down to dew point. Thus condensate is generated and the latent evaporation heat is released. During condensate generation the temperature difference between the warm and cold air streams in the heat exchanger is higher as compared to the process with no condensate. Thus that means higher heat energy extraction and higher heat recovery efficiency.

For that reason free condensate drainage shall be provided.

Use of plate heat exchangers in ventilation system results in shorter payback period and better ecological characteristics ensuring the further advantages:

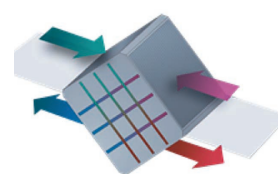

Plate cross-flow heat exchanger operating logic

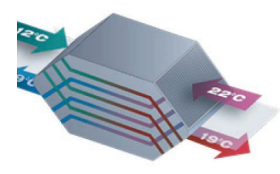

Plate counter-flow heat exchanger operating logic

Series
VENTS VUT(E) 100 P mini



A3 speed switch

Air handling units with heat recovery in the compact sound- and heat-insulated casing. Air flow up to **100 m³/h**. Heat recovery efficiency from 64 up to 76 %.

Description

Compact air supply and exhaust ventilation unit VUE 100 P mini is a simple and effective energy-saving solution ventilation of apartments, cottages, single-family houses, workshops and trade premises. The unit is a fully-featured ventilation unit that provides air cleaning, fresh air supply to the premise and removal of extract air from the premise. Extract air thermal energy is transferred to the cross-flow heat exchanger and is used to warm up the supply air flow. Built-in heat exchanger prevents heat losses and saves operating costs for heating in winter and air conditioning in summer.

Casing

The casing is made of corrosion-resistant aluzink and sound-insulated with 15 mm cellular polyethylene layer. For easy mounting the casing is fitted with mounting brackets. The detachable panel is swivel connected to the unit to provide fast and easy access to the casing internal components for servicing and maintenance. The unit is equipped with two backdraft dampers, one in the supply and the other in the exhaust air duct.

Filter

Supply and extract air flows are purified through two filters with filtering class G4. The filters prevent dirt and dust ingress into the room and protect the unit components against contaminations.

Fans

The unit is equipped with reliable supply and exhaust fans with forward curved blades that are powered by motors with low energy demand. The motor has maintenance-free ball bearings that ensure long service life about 40 000 hrs and are greased for the operation period.

Heat exchanger VENTS VUE 100 P mini

Cross-flow enthalpy heat exchanger with heat recovery efficiency from 64 % up to 72 % enables not only heat but humidity recovery and provides indoor humidity balance. In summer season the heat exchanger serves for intake air cooling down and drying and in

winter season for warming up and moisturizing. Water vapour is extracted from wet extract air and is absorbed by the heat exchanging plates.

Heat exchanger VENTS VUT 100 P mini

The unit is equipped with a high-efficient cross-flow plastic heat exchanger and a drain pan for condensate drainage.

Control

Air flow (speed) is regulated with A3 (P3-1-300) speed switch.

Low speed – 55 m³/h, 24 dBA

Medium speed – 74 m³/h, 32 dBA

Maximum speed – 100 m³/h, 41 dBA

The external speed switch is comfortable to use at any place.

Heat exchanger protection

For freeze protection at low temperatures the unit is equipped with a thermostat inside the casing that switches the supply fan off in case of freezing danger to let extract air warm up the heat exchanger.

Mounting

Due to the compact casing height the unit is designed for horizontal indoor installation behind suspended ceilings and connection to Ø 125 mm round air ducts.

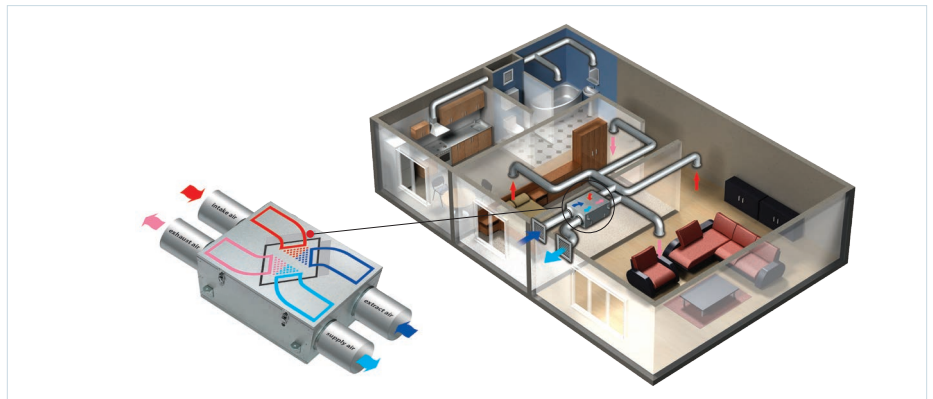

Designation key

Series	Rated air flow [m ³ /h]	Mounting type	Type
VUT: ventilation with heat recovery VUE: ventilation with energy recovery	100	P: suspended	mini

Accessories for air handling units

Model	G4 panel filter	Summer blocks	Silencers		Back valves	Air dampers	Clamps
	VUT 100 P mini	SF 200x190x18 G4	SB C4 200/190	SR 125	SRF 125	KOM 125	KR 125
VUE 100 P mini			600/900/1200	600/900/1200			

Technical data

	VUT 100 P mini			VUE 100 P mini		
Speed	min.	med.	max.	min.	med.	max.
Voltage [V/Hz]	1~230/50			1~230/50		
Unit power [W]	30	38	56	30	38	56
Unit current [A]	0.18	0.23	0.34	0.18	0.23	0.34
Air flow [m³/h]	55	74	100	55	74	100
RPM	1300	1950	2500	1300	1950	2500
Noise level at 3m [dBA]	24	32	41	24	32	41
Transported air temperature [°C]	-25...+40					
Casing material	aluzinc					
Insulation	15 mm cellular polyethylene					
Filter: extract /supply	G4/G4					
Connected air duct diameter [mm]	Ø 125					
Weight [kg]	13			10		
Heat recovery efficiency	from 65 up to 76 %			from 64 up to 72 %		
Heat exchanger type				cross-flow		
Heat exchanger material	plastic			enthalpy		
SEC Class				D		

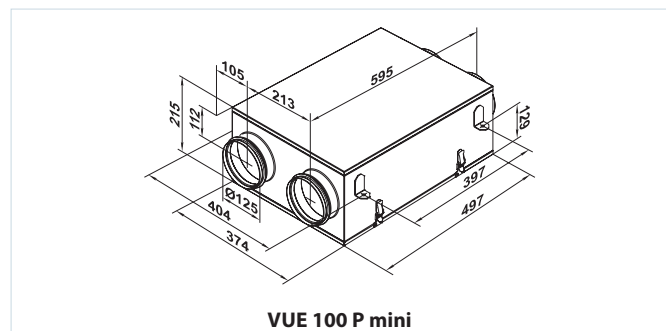
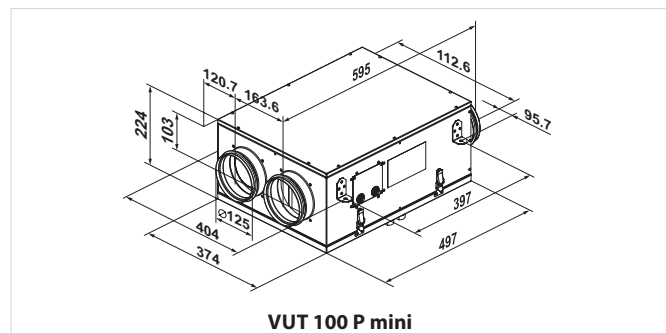
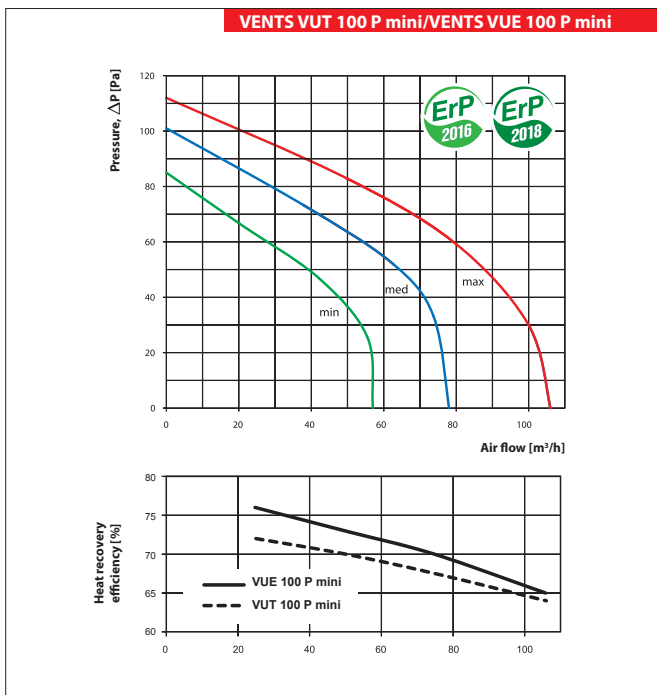

Series
VENTS
VUT/VUE 250 V mini



Air handling units in compact sound- and heat-insulated casing with vertical duct connections.
Maximum air flow – **260 m³/h**

■ **Description**

The VUT/VUE 250 H/V mini A12 air handling units are the fully-featured ventilation units that ensure air filtration, fresh air supply and stale air extract. During the operation process the extract air heat is transferred to the supply air through the plate heat exchanger.

■ **Modifications**

VUT 250 V mini A12: models with vertical duct connections, fans with AC motors with polystyrene heat exchanger.

VUT 250 H mini A12: models with horizontal duct connections, fans with AC motors with polystyrene heat exchanger.

VUE 250 V mini A12: models with vertical duct connections, fans with AC motors with a heat exchanger made of enthalpy.

VUE 250 H mini A12: models with horizontal duct connections, fans with AC motors with a heat exchanger made of enthalpy.

Series
VENTS
VUT/VUE 250 H mini



Air handling units in compact sound- and heat-insulated casing with horizontal duct connections.
Maximum air flow – **260 m³/h**

■ **Casing**

The casing of the VUT/VUE 250 V/H unit is made of aluzinc steel, internally filled with 20 mm mineral wool heat- and sound-insulating layer.

■ **Filter**

Two built-in filters with filtering class G4 provide efficient supply and extract air filtration. F8 filter is available as an option for supply air filtration.

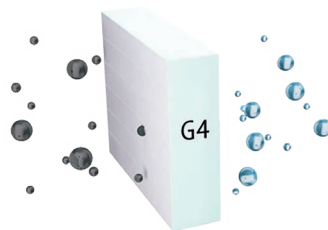

■ **Fans**

The unit is equipped with a supply and exhaust centrifugal fan with backward curved blades and integrated overheating protection thermostat with automatic restart. The motors and the impellers are dynamically balanced.

■ **Heat exchanger**

VUE mini: plate heat exchanger made of enthalpy with heat recovery efficiency up to 78 %. The applied heat exchanger enables not only heat but also humidity recovery, which helps maintaining a comfortable humidity level.

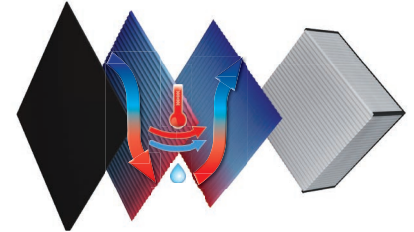

VUT mini: plate heat exchanger made of polystyrene. Whenever heat recovery is not required for unit operation, the heat exchanger block can be easily replaced by a summer block.

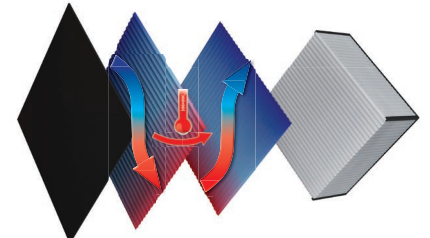

To prevent the heat exchanger freezing, electronic protection system is applied. It switches the supply fan off as the temperature sensor requires.

■ **Control**

The unit is equipped with the A12 (SRS-1) control panel. Speed and rotation control of the single-phase power-controlled motors allows turning the unit on/off and controlling its capacity.

■ **Installation**

Mounting to wall, floor or ceiling with fixing brackets. While mounting provide free access to the service panel for filter replacement and servicing. The correct mounted unit must provide condensate collecting and drainage.

Designation key

Series	Rated air flow [m³/h]	Spigot modification	Model	Casing colour	Integrated automation system
VUT: ventilation with heat recovery VUE: ventilation with energy recovery	250	V: vertical H: horizontal	mini	_: aluzinc White: white painted	A12: control panel (SRS-1)

Overall dimensions of units

Model	Dimensions [mm]					
	ØD	B	H	H1	L	L1
VUT/VUE 250 V mini	125	300	443	490	713	43
VUT/VUE 250 H mini	125	300	443	43	713	810

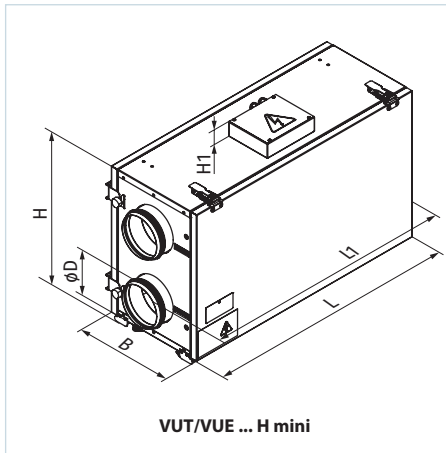
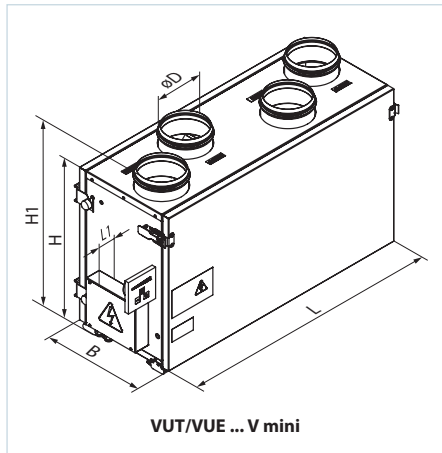







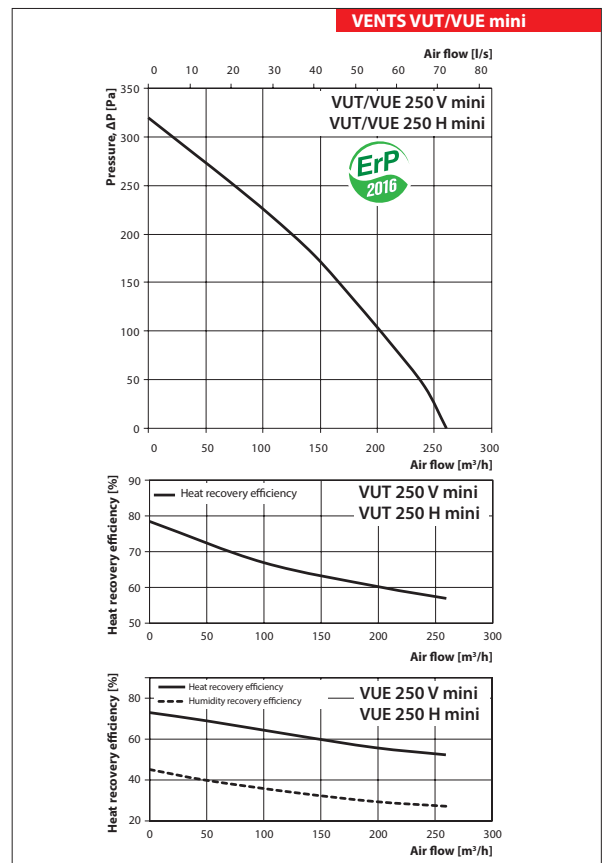

Technical data

	VUT 250 V mini VUT 250 H mini	VUE 250 V mini VUE 250 H mini
Unit voltage [V/50 (60) Hz]	1~230	
Power [W]	126	
Current [A]	0.6	
Maximum air flow [m³/h]	260	
RPM [min⁻¹]	2700	
Sound pressure level at 3 m distance [dBA]	28-47	
Transported air temperature [°C]	-25...+40	
Insulation	20 mm mineral wool	
Filter: extract	G4	
Filter: supply	G4 (F8 PM2.5 81 % – option)	
Connected air duct diameter [mm]	Ø125	
Heat recovery efficiency* [%]	57-78	52-73
Humidity recovery efficiency* [%]	-	27-45
Heat exchanger type	cross-flow	
Heat exchanger material	polystyrene	enthalpy

*Heat recovery efficiency is specified in compliance with EN308 EU.



Accessories for air handling units

Model	G4 panel filter	F8 panel filter	Silencers		Back valves	Air dampers	Clamps	Summer blocks
VUT 250 V mini A12								
VUE 250 V mini A12	SF 240x184x40 G4	SF 240x184x40 F8	SR 125	SRF 125	KOM 125	KR 125	X 125	VL C4 200/240
VUT 250 H mini A12								
VUE 250 H mini A12								

Series
VENTS VUT/VUE V2 mini EC



Air handling units with air flow up to **300 m³/h**.
Heat recovery efficiency up to **79 %**.

■ **Description**

The air handling units are the fully featured ventilation units with heat recovery for air filtration, fresh air supply and stale air extract. During operation the extract air heat is transferred to the supply air stream by the highly efficient plate heat exchanger.

■ **Casing**

The casing of the VUT/VUE 300 V/H mini EC units is of aluzinc steel, internally filled with 20 mm mineral wool heat- and sound-insulating layer.

■ **Fans**

The units are equipped with high-efficient EC motors with an external rotor and forward curved blades.

Series
VENTS VUT/VUE H2 mini EC



Air handling units with air flow up to **300 m³/h**.
Heat recovery efficiency up to **79 %**.

■ **Heat exchanger**

The **VUT V2/H2 mini EC** units are equipped with a cross-flow polystyrene heat exchanger.

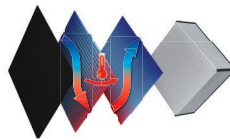

The **VUE V2/H2 mini EC** units are equipped with an enthalpy cross flow heat exchanger.

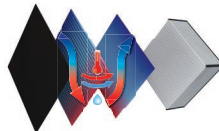

■ **Filter**

Two built-in filters with filtration class G4 and F8 provide efficient supply air filtration. Extract air is cleaned by a built-in filter with filtration class G4.

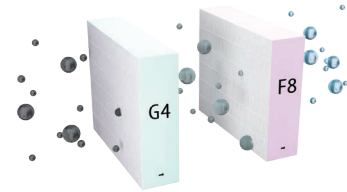

■ **Control and automation**

The VUT/VUE 300 H2/V2 mini EC A2 units are equipped with an A2 speed controller (R-1/010). The VUT/VUE 300 H2/V2 mini EC A14 units are equipped with a remote control panel with touch buttons and LED indication.



To prevent the heat exchanger freezing, electronic protection system is applied. It switches the supply fan off as the temperature sensor requires.



■ **Installation**

Mounting to floor or wall with fixing brackets. The VUE 300 H2 mini EC can also be suspended to the ceiling. The VUT 300 H2 mini EC unit installation position must provide proper condensate drainage.

Accessories

Model	Panel filter G4	Panel filter F8	Indoor humidity sensor (0-10 V)	Outdoor CO ₂ sensor with indication	Outdoor CO ₂ sensor	Outdoor humidity sensor	Kitchen hood
VUT 300 V2/H2 mini EC A2	SF 240x184x40 G4	SF 240x184x40 F8	-	-	-	-	-
VUE 300 V2/H2 mini EC A2							
VUT 300 V2/H2 mini EC A14			HV-2	CO2-1	CO2-2	HR-S	KH-1
VUE 300 V2/H2 mini EC A14							

Model	Silencers		Back valves	Air dampers	Clamps	Hydraulic U-trap	Electric actuator
VUT 300 V2/H2 mini EC A2	SR 125	SRF 125	KOM 125	KRV 125	S 125	SH-32	-
VUE 300 V2/H2 mini EC A2							
VUT 300 V2/H2 mini EC A14							LF230
VUE 300 V2/H2 mini EC A14							

Designation key

Series	Rated air flow [m³/h]	Mounting type	Casing type	Model	Motor type	Casing colour	Control type
VUT: ventilation with heat recovery VUE: ventilation with energy recovery	300	V: vertical installation H: horizontal installation	2: 20 mm insulation	mini	EC: synchronous electronically commutated motor	_: aluzinc White: white painted	A2: speed controller A14: sensor control panel with LED indication

Overall dimensions

Model	Dimensions [mm]					
	Ø D	B	H	H1	L	L1
VUT 300 V2 mini EC	125	287	447	495	714	776
VUT 300 H2 mini EC				510		810

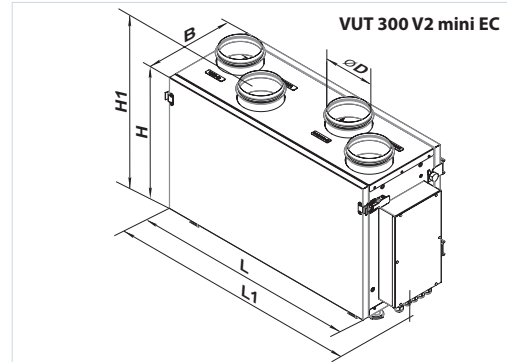
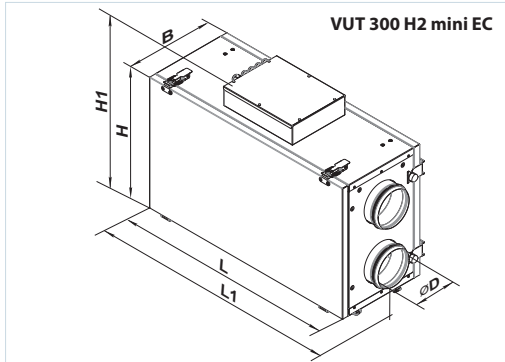

Technical data

	VUT 300 V2 mini EC VUT 300 H2 mini EC	VUE 300 V2 mini EC VUE 300 H2 mini EC
Voltage [V/Hz]	1~230	
Maximum unit power (without a heater) [W]	165	
Maximum unit current (without a heater) [A]	1.3	
Max. air flow [m³/h]	300	
RPM [min ⁻¹]	2050	
Sound pressure level at a distance of 3 m [dBA]	33	
Transported air temperature [°C]	-25...+40	
Insulation	20 mm mineral wool	
Filter: extract filter	G4	
Filter: supply filter	G4, F8 (PM2.5 87%)	
Connected air duct diameter [mm]	Ø125	
Mass [kg]	32	28
Heat recovery efficiency [%]	from 55 up to 79	from 51 up to 73
Humidity recovery efficiency [%]	-	from 26 up to 45
Heat exchanger type	cross-flow	
Heat exchanger material	polystyrene	enthalpy
SEC class (A2)	B	C
SEC class (A14)	A	A

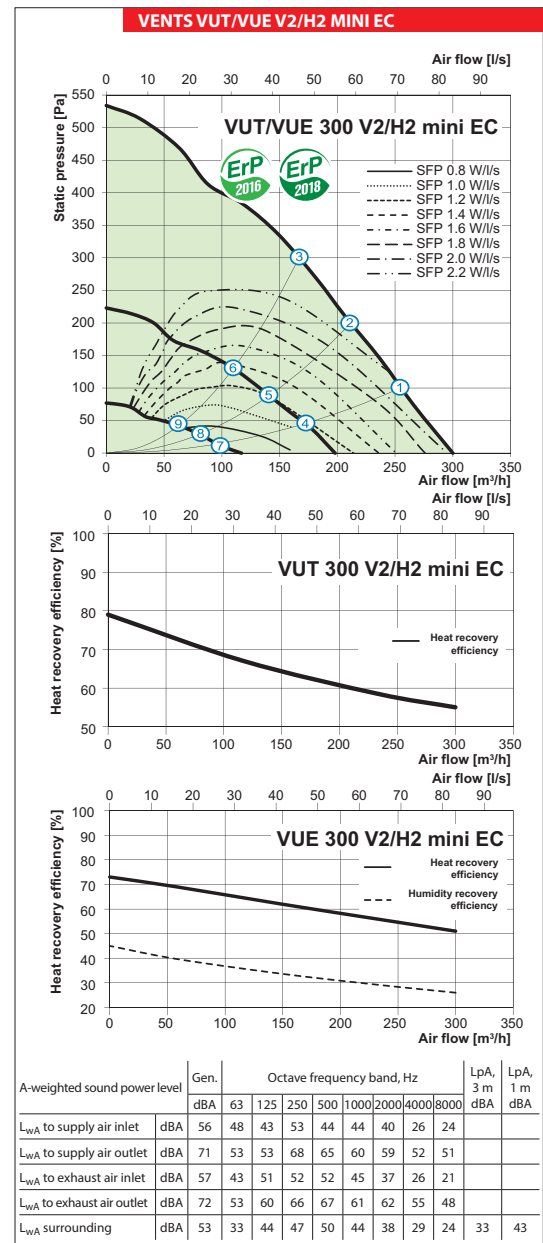

Application options

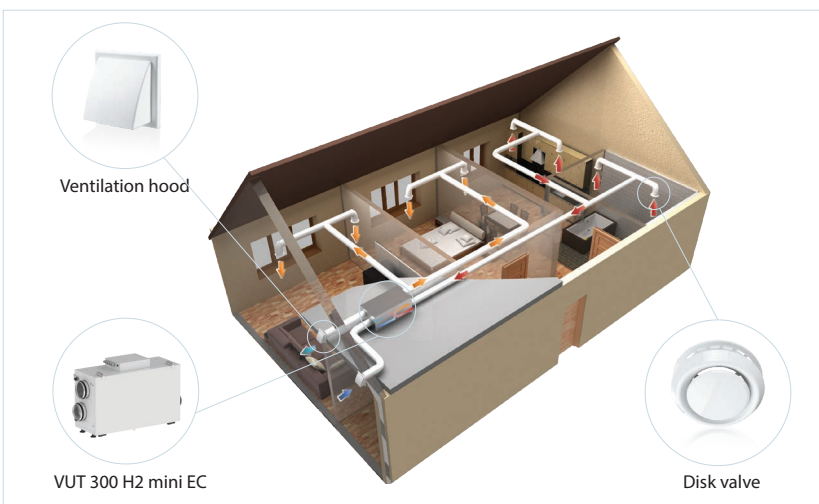

A-weighted sound power level	Gen.	Octave frequency band, Hz								LpA, 3 m dBA	LpA, 1 m dBA	
		63	125	250	500	1000	2000	4000	8000			
L _{WA} to supply air inlet	dBA	56	48	43	53	44	44	40	26	24		
L _{WA} to supply air outlet	dBA	71	53	53	68	65	60	59	52	51		
L _{WA} to exhaust air inlet	dBA	57	43	51	52	52	45	37	26	21		
L _{WA} to exhaust air outlet	dBA	72	53	60	66	67	61	62	55	48		
L _{WA} surrounding	dBA	53	33	44	47	50	44	38	29	24	33	43

Series
VENTS VUE P3



Heat recovery air handling units in heat- and sound-insulated casing with max. air flow **400 m³/h** and heat recovery efficiency **87 %**

■ **Application**

The VUE P3 air-handling units are the fully featured ventilation units with heat recovery for air filtration, fresh air supply and stale air extract. Designed for application in various ventilation systems that require cost-saving and controllable ventilation.

■ **Design**

The casing is made of polymer coated steel panels, internally lined with 5 or 10 mm heat- and sound-insulating layer of cellular polyurethane.

■ **Fans**

Single-phase external rotor motors with forward curved blades. The motors have overheating protection with automatic restart.

■ **Heat recovery**

Enthalpy cross-flow heat exchanger with recovery efficiency to 87 %. The enthalpy heat exchanger enables not only heat, but also humidity recovery.

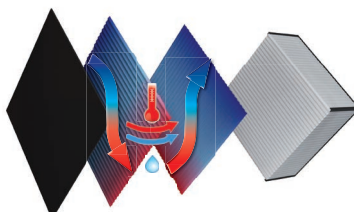

■ **Air filtration**

Efficient supply air filtration with two built-in G4 and F8 panel filters. Extract air filtration with a panel G4 filter.

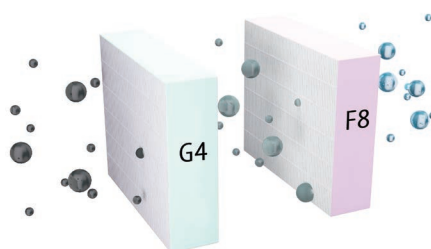

■ **Control and automation**

The VUE P3 A1 unit is equipped with the speed controller RS-1-400.



The VUE P3 A12 unit has the speed controller with touch buttons and LED indication SRS-1.



■ **Freeze protection**

In case of freezing danger determined by the temperature sensor the supply fan is turned off to let extract air warm up the heat exchanger.

■ **Mounting**



Due to low height of the casing the unit offers the optimum solution for the suspended ceiling installation in limited installation space.

Overall dimensions [mm]

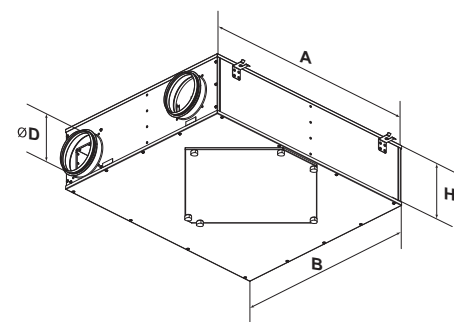
Model	A	B	H	ØD
VUE 150 P3	854	704	227	100
VUE 250 P3	854	704	227	150
VUE 350 P3	1024	754	277	150



Accessories

Model	G4 panel filter	F8 panel filter
		
VUE 150 P3	SF 300 x 220 x 48 G4	SF 300 x 220 x 48 F8
VUE 250 P3	SF 300 x 220 x 48 G4	SF 300 x 220 x 48 F8
VUE 350 P3	SF 300 x 270 x 48 G4	SF 300 x 270 x 48 F8

Designation key

Series	Rated air flow [m ³ /h]	Design features	Casing modification	Service side	Control panel
VENTS VUE: energy recovery ventilation	150; 250; 350	P: suspended mounting	3: low-profile unit	L: left R: right	A1: speed switch RS-1-400 A12: sensor speed control panel SRS-1

Technical data

	VUE 150 P3	VUE 250 P3	VUE 350 P3
Unit supply [V/50 (60) Hz]		1~230	
Power [W]	125	250	310
Current [A]	0.6	1.1	1.4
Max. air flow [m ³ /h]	230	370	400
RPM [min ⁻¹]	2235	2400	2150
Noise level at 3m [dBA]	49	52	57
Transported air temperature [°C]		-5...+40	
Casing material	polymer coated steel		
Insulation	5 mm, 10 mm polyurethane foam		
Extract filter	G4		
Supply filters	G4 and F8 (PM 2,5 93 %)	G4 and F8 (PM 2,5 83 %)	G4 and F8 (PM 2,5 87 %)
Connected air duct diameter [mm]	100	150	150
Heat recovery efficiency [%]*	72 up to 87	66 up to 76	71 up to 87
Humidity recovery efficiency [%]	27 up to 47	22 up to 32	23 up to 40
Heat exchanger type	cross-flow		
Heat exchanger material	enthalpy		
Mass [kg]	26	29	42
SEC class	D	E	E

* Heat recovery efficiency is calculated in compliance with EN 13141-7

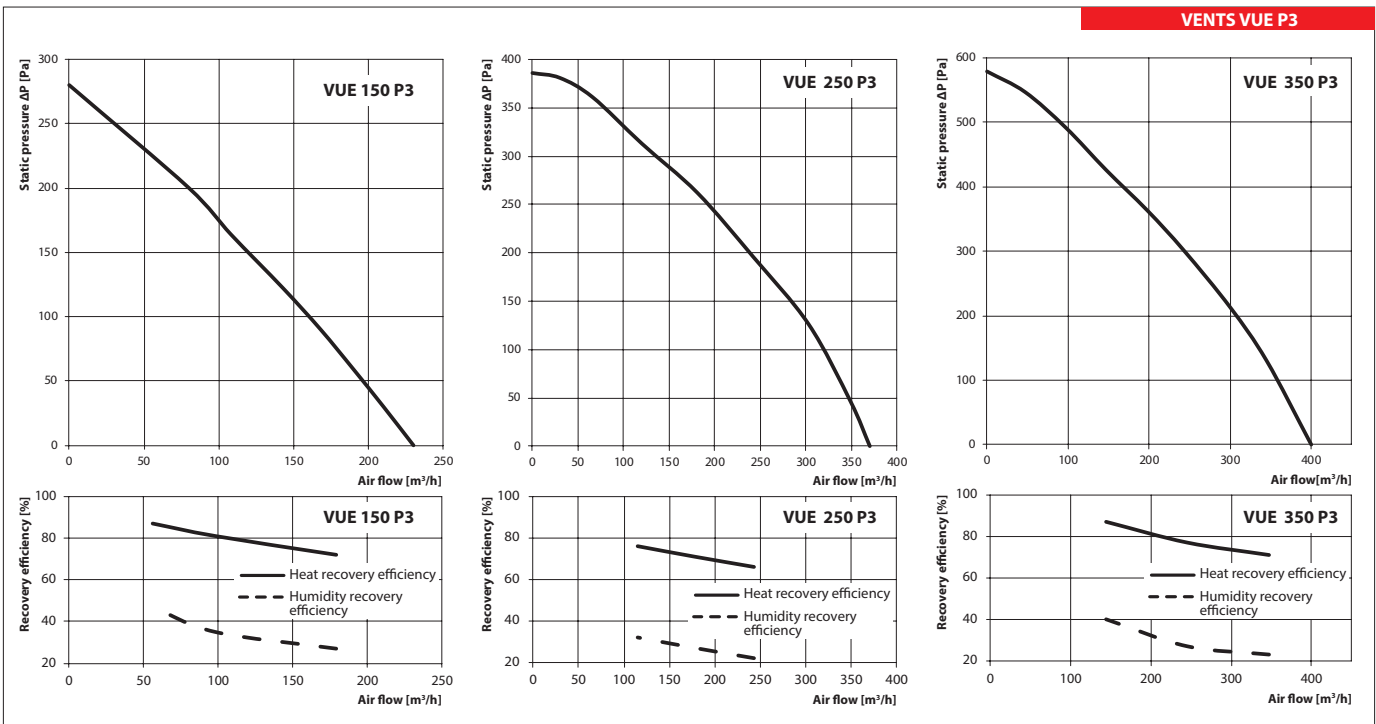

Application example

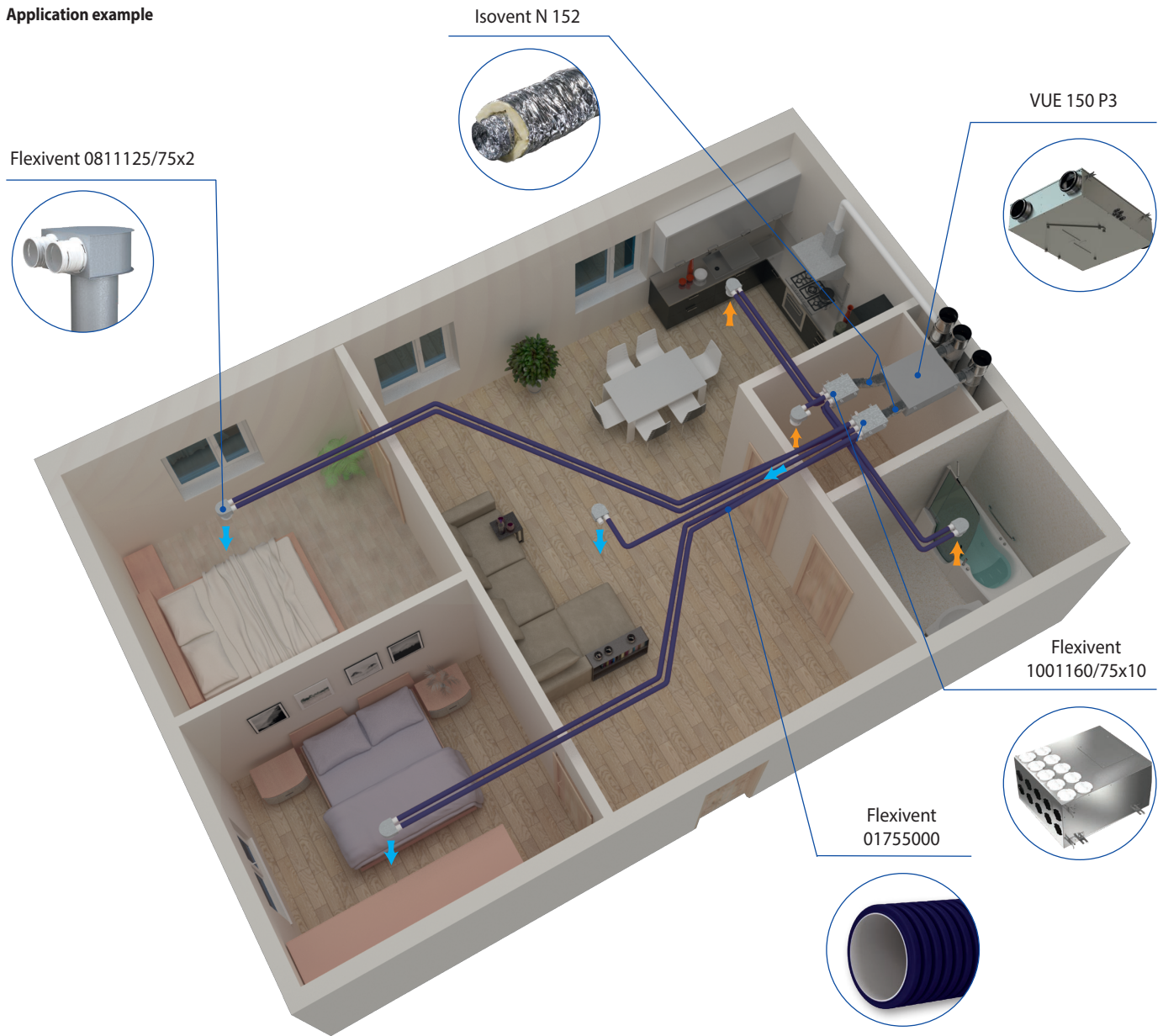

Series
VENTS VUE P3B EC



Air handling units with air capacity up to **400 m³/h**.
Heat recovery efficiency up to **85 %**

Application

The air handling units VUE P3B EC are the fully-featured ventilation units that ensure air filtration, fresh air supply and stale air extract.

Design

The casing is made of polymer-coated steel panels, internally filled with polyurethane foam layer 5 or 10 mm for heat- and sound-insulation.

Fans

High-efficient electronically-commutated (EC) motors with an external motor. The VUE 100 P3B EC A14, VUE 150 P3B EC A14 and VUE 250 P3B EC A14

are equipped with centrifugal impellers with forward curved blades. The VUE 350 P3B EC A14 are equipped with centrifugal impellers with backward curved blades.

Heat recovery

Enthalpy cross-flow heat exchanger made of polymerized cellulose with heat recovery efficiency up to 85 %. The applied heat exchanger enables not only heat but also humidity recovery.

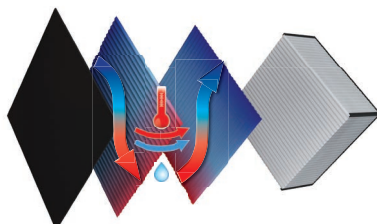

Bypass

The units are equipped with a bypass for summer ventilation (air cooling by the cool air from outside).

Air filtration

Two built-in panel filters with filtering class G4 and F8 provide efficient supply air filtration. Extract air is cleaned by the built-in G4 filter.

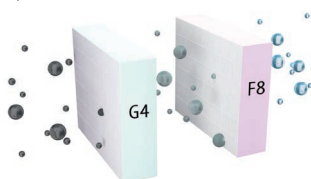

Control and automation

The VENTS VUE P3B EC A14 units have an integrated automation system with a wall-mounted control panel A14 with a LED indication. The units are equipped with a USB connector (Type B) and can be connected to a PC for configuring the advanced settings in a special software.



The standard delivery set includes a 10 m cable for connection of the unit to the control panel.

A14 automation functions:

- ▶ Turning the unit on/off.
- ▶ Unit performance control (selection of Low, Medium or High speed).
- ▶ Bypass damper opening and closing for summer ventilation.
- ▶ Alarm indication.
- ▶ Filter replacement notification.

Additional functions of the A14 automation with installed software

- ▶ Fan speed adjustment from 0 to 100 %.
- ▶ Each speed is individually adjusted for the supply and the extract fans.
- ▶ Operation control on feedback from the HV-2 duct humidity sensor (to be ordered separately).
- ▶ Unit operation setting according to the external relay (to be ordered separately).
- ▶ Temperature setting for heat exchanger freeze protection system activation.
- ▶ Control and operation adjustment of the filter maintenance timer.
- ▶ Error code indication.
- ▶ Software version upgrading.
- ▶ External relay, bypass and humidity control.

Installation

Due to a low casing height the air handling units are a perfect solution for space-restricted installation above suspended ceilings.

Accessories for air handling units

Model	G4 panel filter	F8 panel filter	Internal humidity sensor (0-10 V)	External CO ₂ sensor	External CO ₂ sensor with indication	External humidity sensor	Hydraulic kit	Air dampers	Electric actuator
VUE 100 P3B EC A14	SF 200x191x20 G4	SF 200x191x20 F8							KRV 100
VUE 150 P3B EC A14	SF 300x220x48 G4	SF 300x220x48 F8	HV-2	CO2-1	CO2-2	HR-S	SH-32		LF230
VUE 250 P3B EC A14	SF 300x220x48 G4	SF 300x220x48 F8							KRV 150
VUE 350 P3B EC A14	SF 300x270x48 G4	SF 300x270x48 F8							

Designation key

Series	Rated air flow [m³/h]	Mounting type	Casing modification	Bypass	Motor type	Service side	Control panel
VENTS VUE	100; 150; 250; 350	P: suspended	3: low-profile unit	B: integrated bypass	EC: synchronous electronically commutated motor	L: left R: right	A14

Overall dimensions

Model	Dimensions [mm]			
	Ø D	A	B	H
VUE 100 P3B EC A14	99	600	481	207
VUE 150 P3B EC A14	99	854	704	222
VUE 250 P3B EC A14	149	854	704	227
VUE 350 P3B EC A14	149	1024	754	277

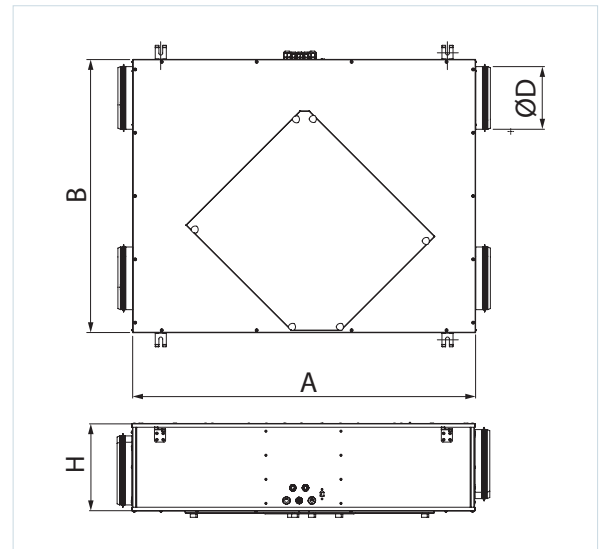

Technical data

Point	Unit power [W]			
	VUE 100 P3B EC A14	VUE 150 P3B EC A14	VUE 250 P3B EC A14	VUE 350 P3B EC A14
1	62	75	80	147
2	55	70	67	145
3	48	53	59	144
4	30	37	43	75
5	27	33	34	73
6	25	28	28	70
7	13	14	23	21
8	13	13	22	21
9	12	12	19	20

	VUE 100 P3B EC A14	VUE 150 P3B EC A14	VUE 250 P3B EC A14	VUE 350 P3B EC A14
Unit voltage [V /50(60) Hz]	1~230			
Maximum unit power [W]	66	83	84	171
Maximum unit current [A]	0.5	0.7	0.7	1.3
Maximum flow rate [m³/h]	170	215	300	430
RPM [min ⁻¹]	2800	2000	2000	3200
Sound pressure level at 3 m distance [dBA]	30	32	36	46
Transported air temperature [°C]	-5...+40			
Casing material	painted steel			
Insulation	foamed polyurethane, 5 and 10 mm			
Extract filter	G4			
Supply filters	G4 and F8 (PM2.5 93 %)	G4 and F8 (PM2.5 93 %)	G4 and F8 (PM2.5 83 %)	G4 and F8 (PM2.5 87 %)
Connected air duct diameter [mm]	Ø 100	Ø 100	Ø 150	Ø 150
Heat recovery efficiency [%]	70 – 82	68 – 82	63 – 73	68 – 85
Humidity recovery efficiency [%]	24 – 41	22 – 41	16 – 27	19 – 34
Heat exchanger type	cross-flow			
Heat exchanger material	polymerized cellulose			
Weight [kg]	17	26	29	42
SEC class	A	A	A	A

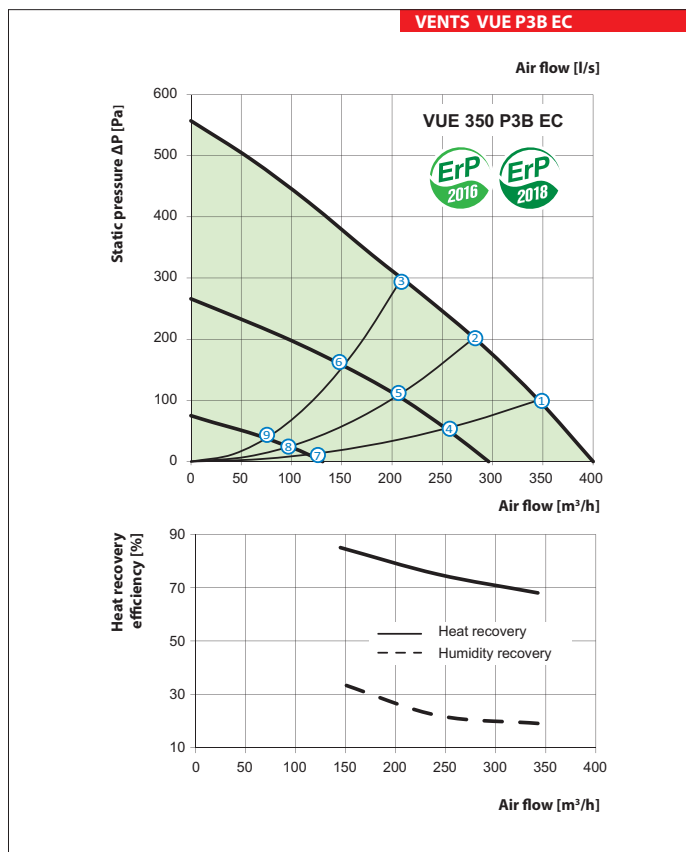
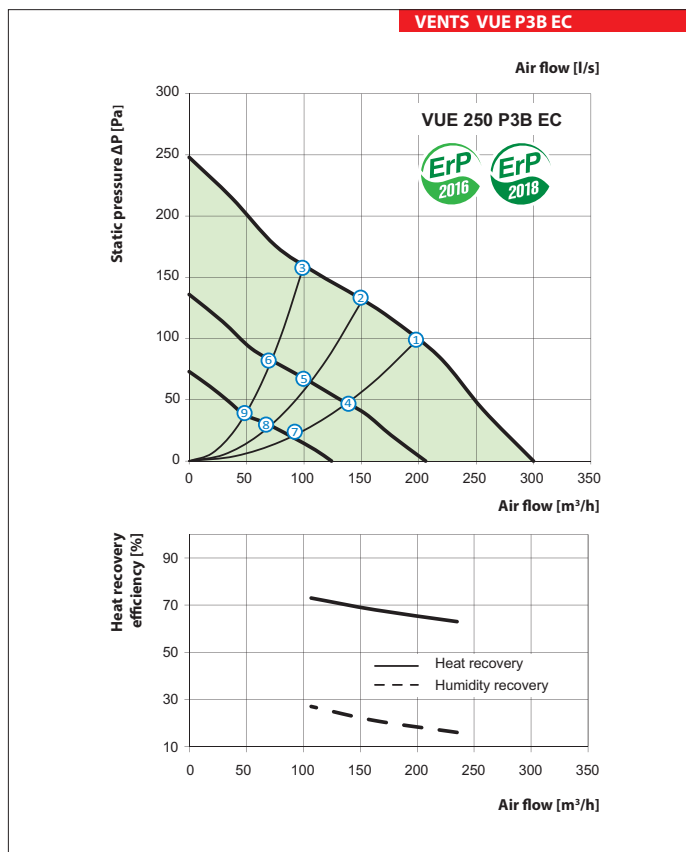
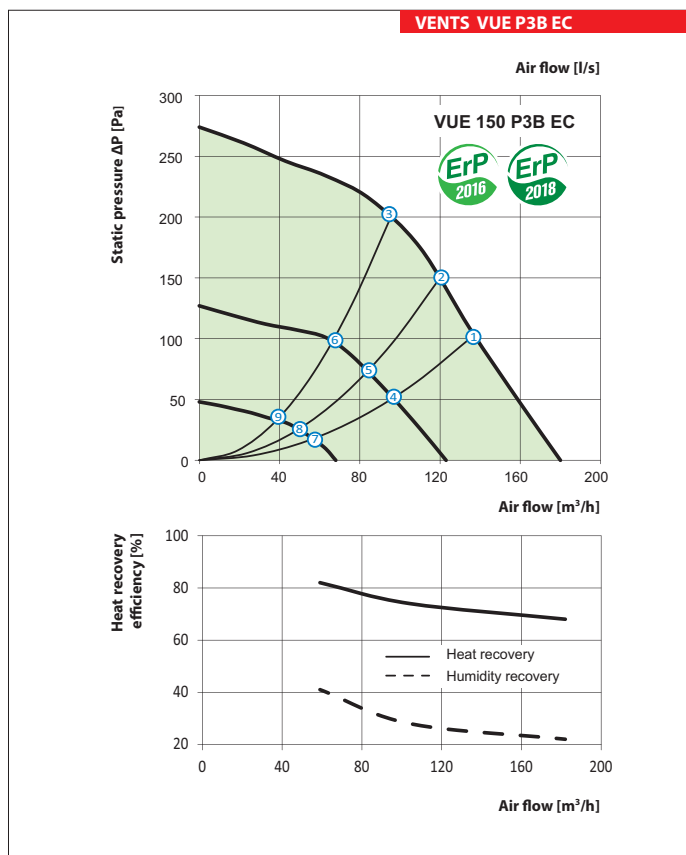
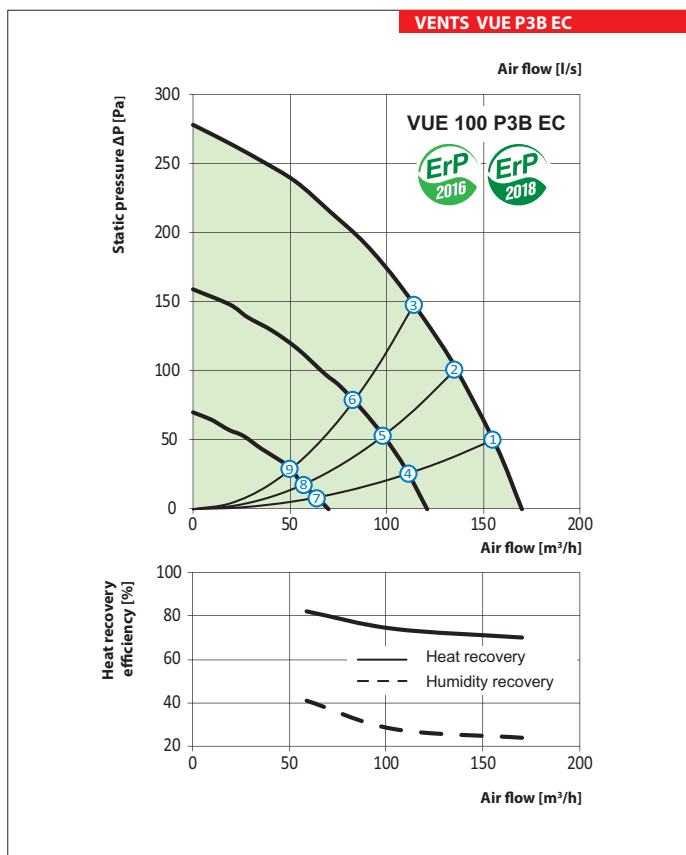

Application

VENTS VUE P3B EC



Disk valve

Manifold

FlexiVent air duct

Connector

Series
VENTS
VUT/VUE 180 P5B EC



Heat recovery air handling units in sound- and heat-insulated casings. Air flow up to **220 m³/h**. Heat recovery efficiency up to **98 %**

■ **Description**

The air handling units are the fully featured ventilation units with heat recovery for air filtration, fresh air supply and stale air extract.

■ **Casing**

The casing is made of expanded polypropylene (EPP) possessing high heat- and sound-insulating properties.

■ **Filter**

Two built-in G4 and F7 filters provide efficient supply air filtration. The G4 filter is used for extract air filtration.

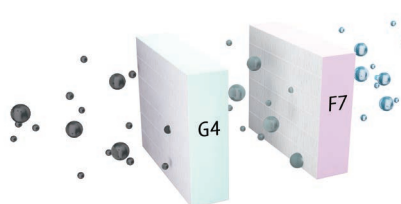

■ **Fans**

Efficient electronically commutated motors with external rotor and impeller with forward curved blades. Such motors are the most state-of-the-art energy saving solution.

■ **Heat exchanger**

The **VUT 180 P5B EC** units are equipped with a counter-flow polystyrene heat exchanger.

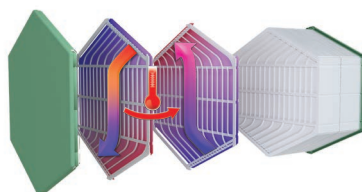

The **VUE 180 P5B EC** units are equipped with an enthalpy counter-flow heat exchanger.

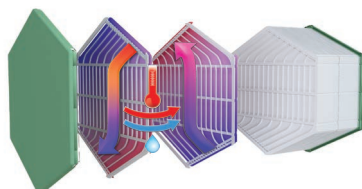

■ **Bypass**

The **VUT/VUE 180 P5B EC A14/A21** units are equipped with a bypass for summer cooling.

■ **Automation**

The **VUT/VUE 180 P5B EC A21** units are equipped with integrated control system. The A21 controller allows integrating the unit into the Smart Home system or BMS (Building Management Systems). The unit is controlled via Wi-Fi by means of the VENTS Home mobile application that must be downloaded.

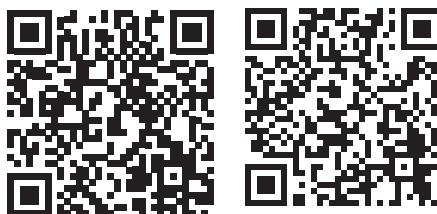

Google play

Download on the App Store



The **VUT/VUE 180 P5B EC A14** units are equipped with integrated control system and the A14 wall-mounted control panel with LED indication.

■ **Freeze protection**

For **VUT/VUE 180 P5B EC A14** the freeze protection is realized by means of shutdown the supply fan.

For **VUT/VUE 180 P5B EC A21** the freeze protection is realized by means of turning the preheater on (available as an accessory).

■ **Mounting**

The unit is designed for suspended ceiling, wall horizontal or vertical installation using the fixing brackets. The mounting position of the unit must provide service access for maintenance and repair.

■ **Control and automation**

Functions	A21	A14
Wi-Fi control via mobile application	+	-
Control via external wired control panel	Option (A22)	A14
Wired remote LCD control panel	Option (A25)	-
Control via external wireless control panel	Option (A22 Wi-Fi)	-
BMS	RS-485 Wi-Fi Ethernet MODBUS (RTU, TCP)	-
Service Vents Cloud Server	+	-
Speed selection	+	+
Filter replacement indication	According to filter timer	According to filter timer
Alarm indication	Full alarm description in the mobile application	Alarm LED indication
Week scheduled operation	+	-
Bypass	Auto Manual	- Manual
Timer	+	-
Boost mode	+	-
Fireplace mode	+	-
Freeze protection	Cyclic shut-down of supply fan Preheating (option)	Cyclic shut-down of supply fan -
Reheater connection	Option	-
Cooler connection	Option	-
Control of minimum supply air temperature	+	-
Humidity control	Option	Option
CO ₂ control	Option	Option
VOC control	Option	-
PM2.5 control	Option	-
Fire detector	Option	Option

*Option. The function is available in case of mounting a respective accessory.

Designation key

Series	Rated air flow [m ³ /h]	Mounting type	Casing design	Bypass	Motor type	Control
VUT: ventilation with heat recovery VUE: ventilation with energy recovery	180	P: suspended mounting	5: expanded polypropylene	B: integrated bypass	EC: synchronous electronically commutated motor	A14 A21

Overall dimensions

Model	Dimensions [mm]								
	Ø D	Ø D1	B	B2	L	L1	H	H1	H2
VUT 180 P5B EC	150	19	600	326	900	1009	264	38	302
VUT 180 P5B EC	150	-	600	326	900	1009	264	-	-

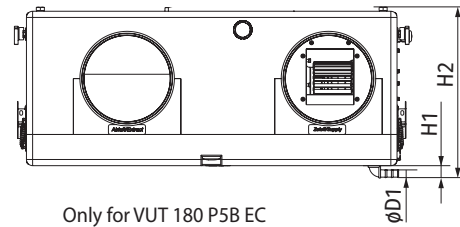
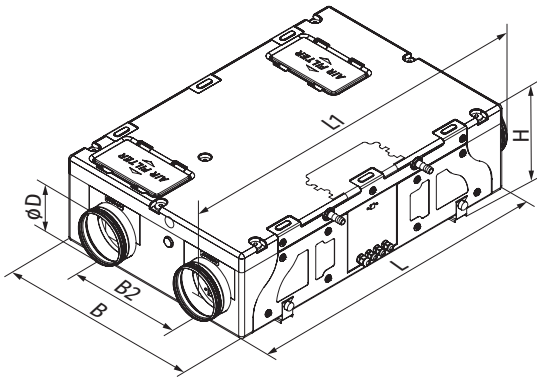

VUT 180 P5B EC unit design

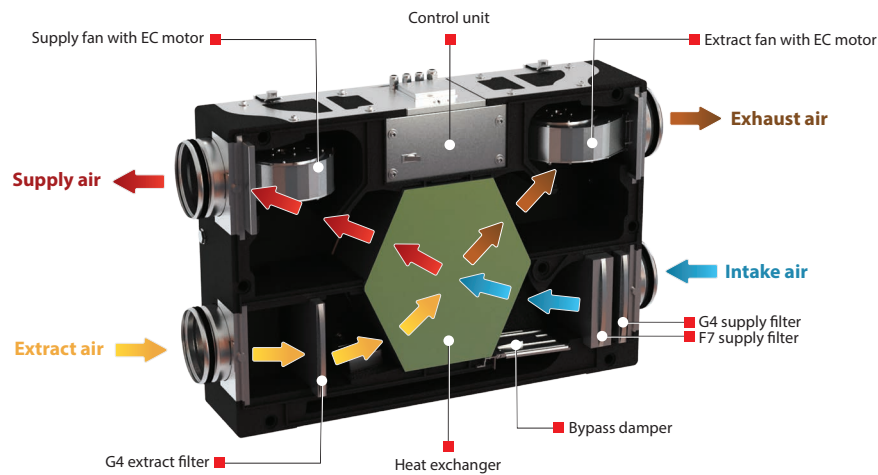

Accessories for air handling units

Model	G4 panel filter	F7 panel filter	LCD control panel	Control panel	Wi-Fi controllable control panel	Internal humidity sensor	CO ₂ sensor with indication	CO ₂ sensor	Humidity sensor	VOC sensor (0-10 V)	CO ₂ sensor (0-10 V)	Humidity sensor (0-10 V)	Reheater	Preheater	Syphon kit	Air damper	Electric actuator	
VUT 180 P5B EC A21																		
VUE 180 P5B EC A21	SF	SF	A25	A22	A22	HV2	CO2-1	CO2-2	HR-5	DPWQ	DPWQ	DPWC	NKD	NKP	SH-32	KRV	LF230	
VUT 180 P5B EC A14	214x186x18 G4	214x186x48 F7	-	-	-					30600	40200	11200	-	-	SH-32	150		
VUE 180 P5B EC A14																		

Technical data

	VUT 180 P5B EC	VUE 180 P5B EC
Voltage 50 (60) Hz [V]	1~230	
Maximum power [W]	87	
Maximum current [A]	0.71	
Maximum air flow [m³/h]	220	
RPM [min ⁻¹]	2200	
Sound pressure level at 3 m distance [dBA]	33	
Transported air temperature [°C]	-25...+40	
Casing mater	Expanded polypropylene (EPP)	
Insulation	EPP 30-15 mm	
Extract filter	G4	
Supply filter	G4, F7	
Connected air duct diameter [mm]	Ø150	
Weight [kg]	14	14
Recovery efficiency [%]	86 up to 98	79 up to 94
Heat exchanger type	Counter-flow	
Heat exchanger material	Polystyrene	Enthalpy
SEC class for A14, A21	A+	A+
SEC class for A2	A	A

Point	Power, W		Sound pressure level at 3 m (1 m) distance [dBA]
	VUT/VUE 180 P5B EC	VUT/VUE 180 P5B EC	
1	77		33 (43)
2	64		33 (43)
3	53		32 (42)
4	31		29 (39)
5	30		28 (38)
6	26		27 (37)
7	14		23 (33)
8	13		21 (31)
9	12		19 (29)

Exhaust air spigot configuration	Air flow [l/s]	Specific fan power [W/l/s]	Recovery efficiency [%]
Kitchen + 1 additional wet room	21	0.90	88
Kitchen + 2 additional wet rooms	29	1.00	86
Kitchen + 3 additional wet rooms	37	1.20	85

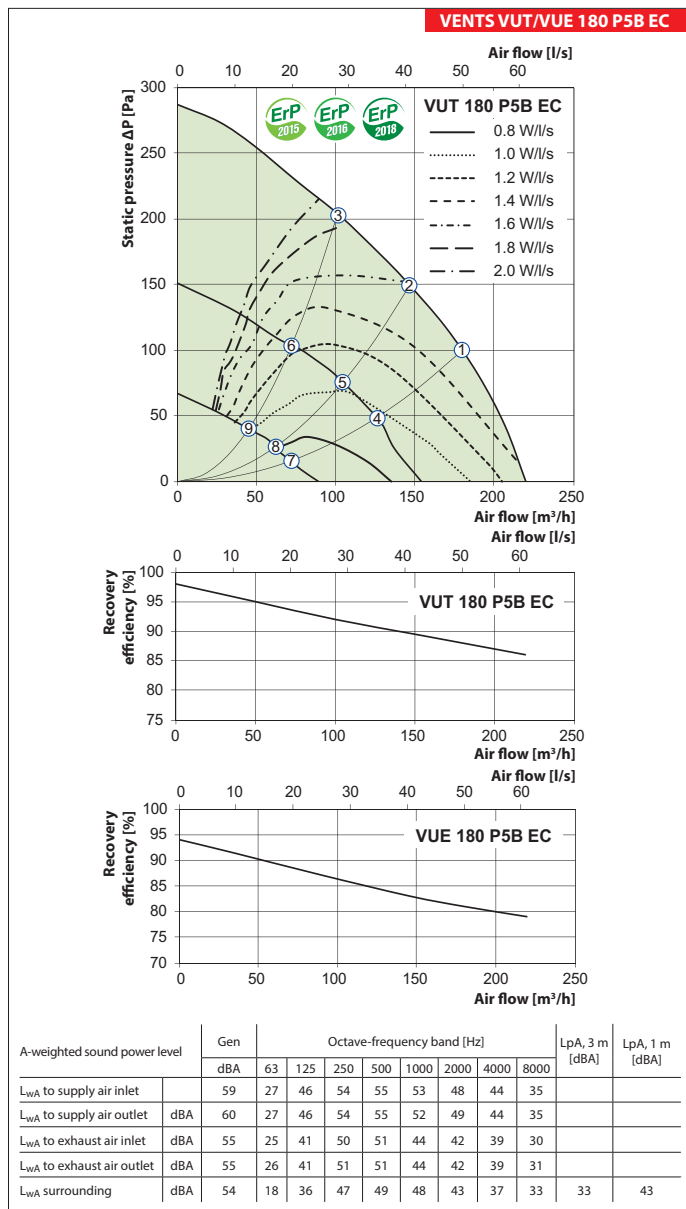

Calculation of air temperature downstream of the heat exchanger:

$$t_{\text{outd}} = t_{\text{hr}} + k_{\text{hr}} * (t_{\text{extr}} - t_{\text{outd}}) / 100,$$

where

t_{outd} is outdoor air temperature [°C]

t_{extr} is extract air temperature [°C]

k_{hr} is heat exchanger efficiency (according to the diagram) [%]

Application options

Ceiling connector with disc valve

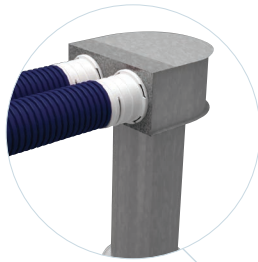

Air distribution box

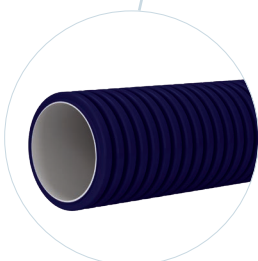
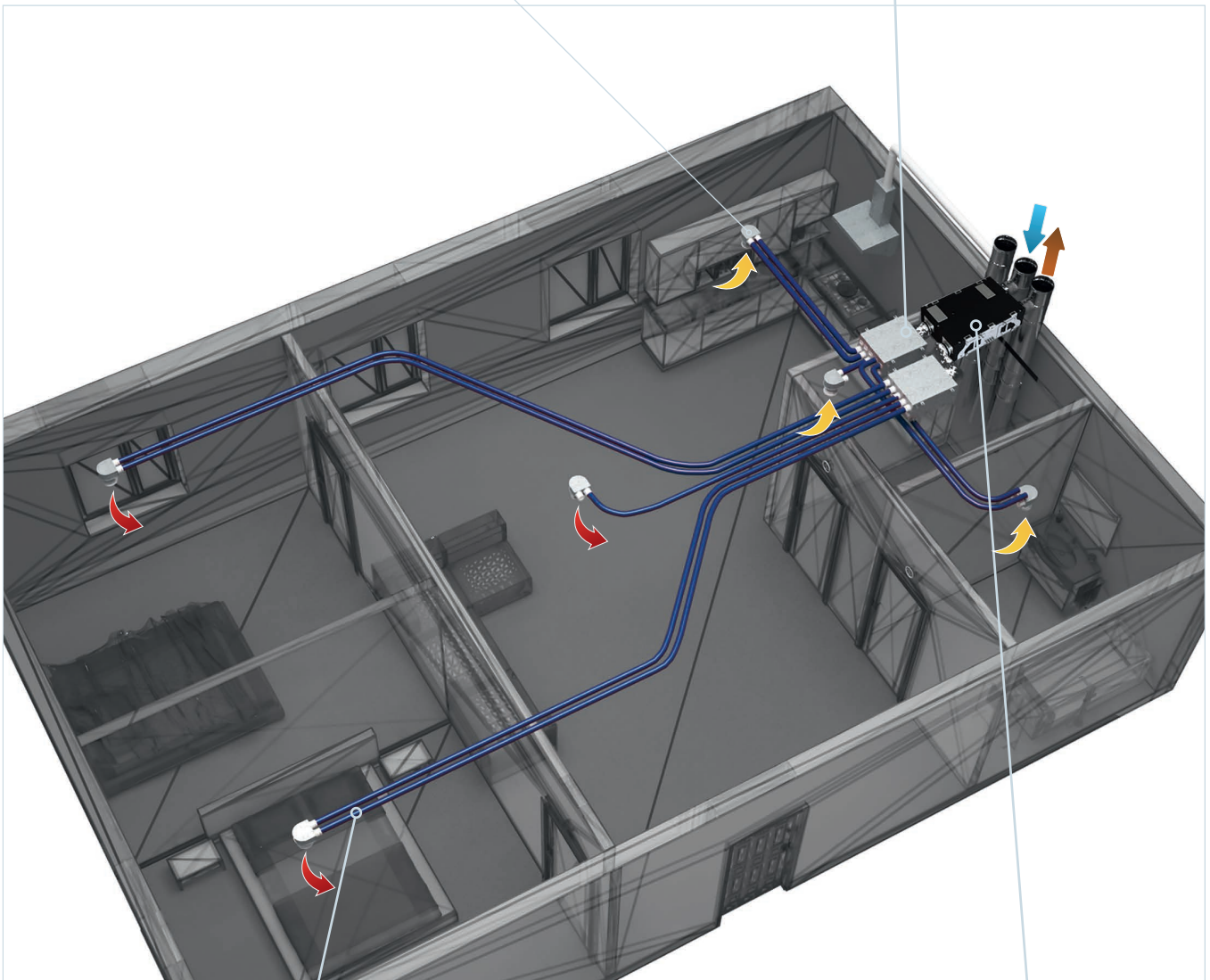
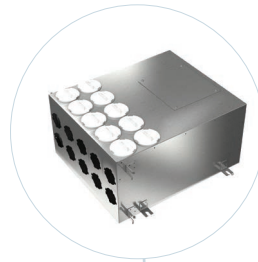

FlexiVent air duct



Air handling unit

Series
VENTS
VUT/VUE 270 V5B EC



Heat recovery air handling units in sound- and heat-insulated casings.
Air flow up to 300 m³/h.
Heat recovery efficiency up to 98 %

Description

The air handling units are the fully featured ventilation units with heat recovery for air filtration, fresh air supply and stale air extract.

Casing

The casing is made of 15-26 mm thick expanded polypropylene (EPP), possessing high heat- and sound-insulating properties.

Filter

Supply and extract air flows are purified through G4 panel filters. For extra supply air filtration a F8 filter is available as a specially ordered accessory.

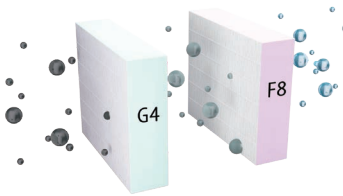

Fans

High-efficient electronically commutated motors with external motor and impeller with backward curved blades.

Designation key

Series	Rated air flow [m ³ /h]	Installation type	Casing design	Bypass	Motor type	Control
VUT: ventilation with heat recovery VUE: ventilation with energy recovery	270	V: vertical	5: expanded polypropylene (EPP)	B: integrated bypass	EC: synchronous electronically commutated motor	A14 A21

Heat exchanger

The VUT 270 V5B EC units are equipped with a counter-flow polystyrene heat exchanger.

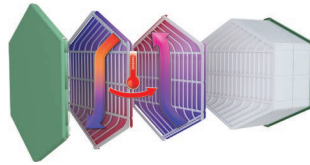

The VUE 270 V5B EC units are equipped with an enthalpy counter-flow heat exchanger.

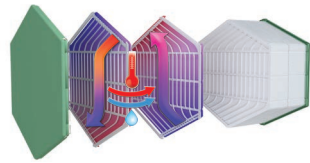

Bypass

The **VUT/VUE 270 V5B EC** units are equipped with a bypass for summer ventilation (cooling of the premise with a cool outside air).

Automation

The **VUT/VUE 270 V5B EC A21** units are equipped with control system. The A21 controller allows integrating the unit into the Smart Home system or BMS (Building Management Systems).

The unit is controlled via Wi-Fi by means of the VENTS Home mobile application that must be downloaded.

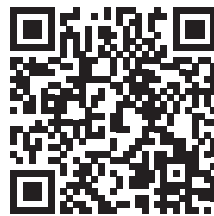

Google play



Download on the App Store



The **VUT/VUE 270 V5B EC A14** units are equipped with integrated control system and wall-mounted sensor control panel A14 with LED indication.

Freeze protection

For **VUT/VUE 270 V5B EC A14** the freeze protection is realized by means of shutdown the supply fan.

For **VUT/VUE 270 V5B EC A21** the freeze protection is realized by means of turning the preheater (available as an accessory) on.

Installation

The units are designed for wall and floor mounting. The access for unit and filter maintenance is available on the right and left side.

Control and automation

Functions	A21	A14
	option (A22)	A14
External wired control panel		
Wired remote LCD control panel	option (A25) 	-
External wireless control panel	option (A22 Wi-Fi) 	-
BMS	RS-485 WI-FI Ethernet MODBUS (RTU, TCP)	-
Service Vents Cloud Server	+	-
Wi-Fi control via mobile application	+	-
Speed selection	+	+
Filter replacement indication	according to filter timer	according to filter timer
	according to pressure switch of filter clogging	-
Alarm indication	full alarm description in the mobile application	alarm LED indication
Week scheduled operation	+	-
Bypass	auto	-
	manual	manual
Timer	+	-
Boost mode	+	-
Fireplace mode	+	-
Freeze protection	cyclic shut-down of supply fan	cyclic shut-down of supply fan
	preheating (option)	-
Reheater connection	option	-
Cooler connection	option	-
Control of minimum supply air temperature	+	-
Humidity control	option	option
CO ₂ control	option	option
VOC control	option	-
PM2.5 control	option	-
Fire detector	option	option

*Option. The function is available in case of mounting a respective accessory.

Overall dimensions

Model	Dimensions [mm]			
	Ø D	B	H	L
VUT/VUE 270 V5B EC	125	590	893	316

External automation unit (only units with A21 automation)	Dimensions [mm]					
	L1	L2	L3	H1	H2	H3
	324	313	93	180	330	196

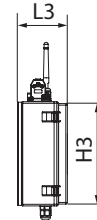
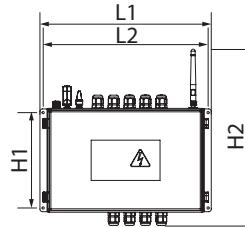
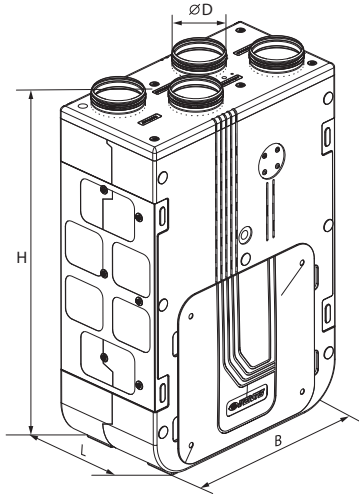

Unit design

- Spigots
- Cable slots
- Extract fan with EC-motor
- Control unit
- G4 extract filter
- G4 supply filter
- Heat exchanger
- F8 supply filter (Option)
- Supply fan with EC-motor
- Drain pan
- Bypass



Accessories for air handling units

Model	G4 panel filter	F8 panel filter	LCD control panel	Control panel	Wi-Fi controllable control panel	Internal humidity sensor	CO ₂ sensor with indication	CO ₂ sensor	Humidity sensor	VOC sensor (0-10 V)	CO ₂ sensor (0-10 V)	Humidity sensor (0-10 V)	Reheater	Preheater	Syphon kit	Air damper	Electric actuator	
VUT 270 V5B EC A21																		
VUE 270 V5B EC A21	SF	SF	A25	A22	A22 Wi-Fi					DPWQ 30600	DPWQ 40200	DPWC 11200	NKD 125	NKP 125	SH-32	KRV 125	LF230	
VUT 270 V5B EC A14	G4	F8	-	-	-	HV2	CO2-1	CO2-2	HR-S	-	-	-	-	-	SH-32	-	-	
VUE 270 V5B EC A14			-	-	-													

Technical data

	VUT 270 V5B EC	VUE 270 V5B EC
Voltage 50 (60) Hz [V]		1~230
Maximum power [W]		162
Maximum current [A]		1.2
Maximum air flow [m³/h]		300
RPM [min ⁻¹]		3200
Sound pressure level at 3 m distance [dBA]		34
Transported air temperature [°C]		-25...+40
Casing mater	expanded polypropylene (EPP)	
Insulation	EPP 15...26 mm	
Extract filter	G4	
Supply filter	G4 (optional F8)	
Connected air duct diameter [mm]	Ø125	
Weight [kg]	13	13.5
Recovery efficiency [%]	87 up to 98	72 up to 94
Heat exchanger type	counter-flow	
Heat exchanger material	polystyrene	enthalpy
SEC class for A14, A21	A+	A
SEC class for A2	B	B

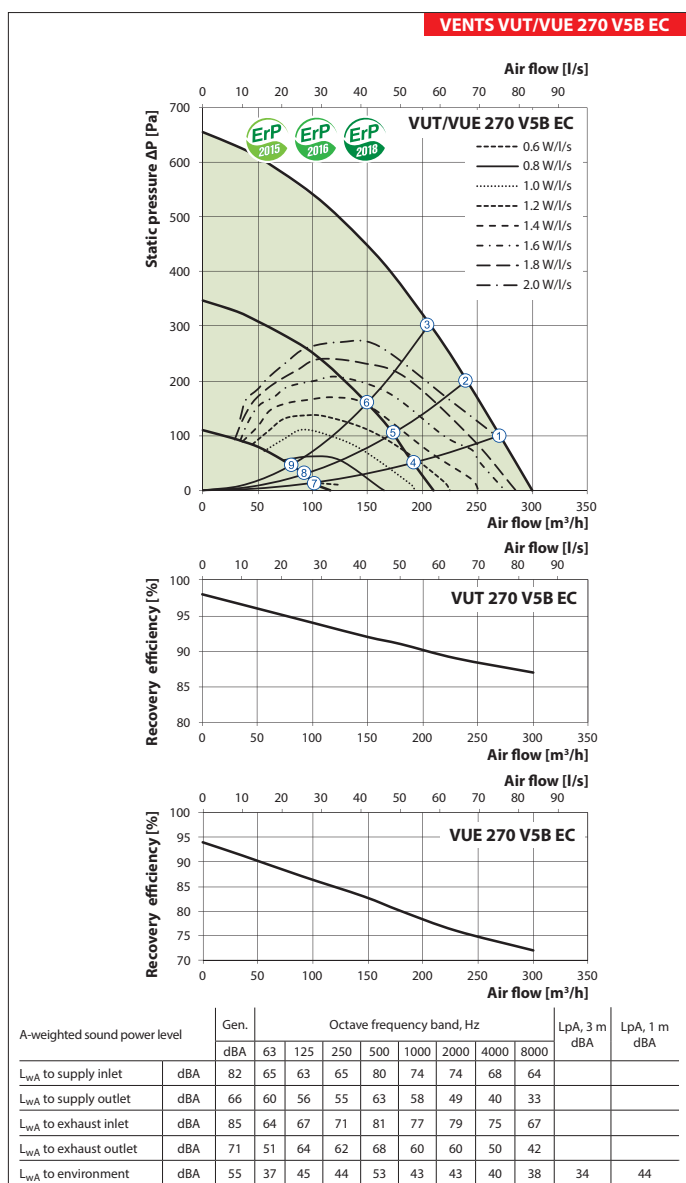

Point	Power, W	Sound pressure level at 3 m (1 m) distance [dBA]
	VUT/VUE 270 V5B EC	VUT/VUE 270 V5B EC
1	153	34 (44)
2	150	34 (44)
3	142	33 (43)
4	62	30 (40)
5	60	29 (39)
6	59	28 (38)
7	17	27 (37)
8	17	23 (33)
9	16	23 (33)

Exhaust air spigot configuration	Air flow [l/s]	Specific fan power [W/l/s]	Recovery efficiency [%]
Kitchen + 1 additional wet room	21	0,73	85
Kitchen + 2 additional wet rooms	29	0,86	84
Kitchen + 3 additional wet rooms	37	1,08	82
Kitchen + 4 additional wet rooms	45	1.39	81

Calculation of air temperature at heat exchanger outlet:

$$t = t_{\text{outd}} + k_{\text{hr}} * (t_{\text{extr}} - t_{\text{outd}}) / 100,$$

where

t_{outd} is outdoor air temperature [°C]

t_{extr} is extract air temperature [°C]

k_{hr} is heat exchanger efficiency (according to the diagram) [%]

Application options

Ventilation hood



Ceiling connector with a disk valve

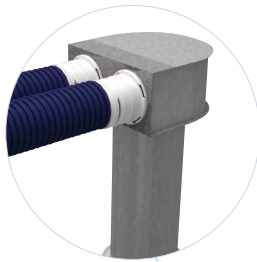

Isovent 150 insulated air duct

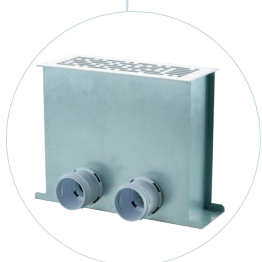
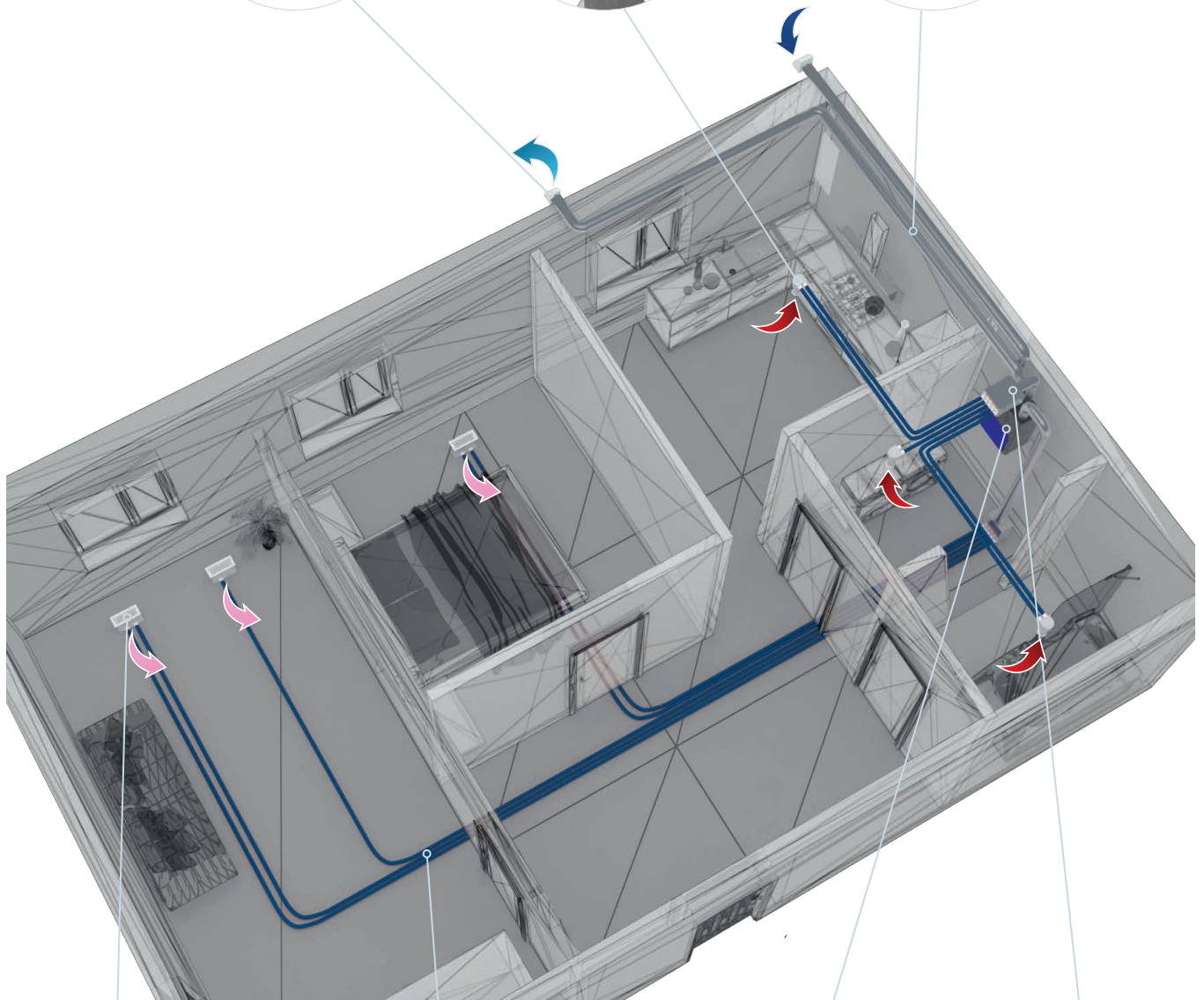

Floor connector with a grille

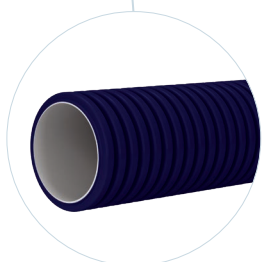

FlexiVent air duct



Air handling unit

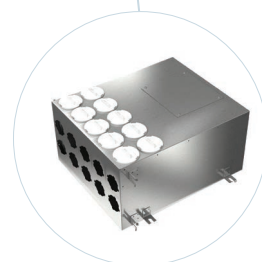

Manifold

Series
VENTS VUT PB EC

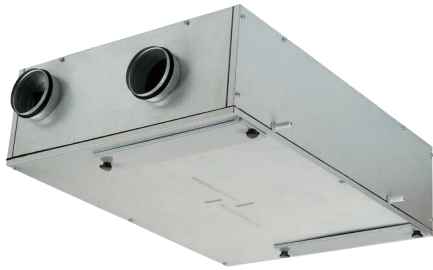

Air handling units in heat- and sound-insulated casing.
Air flow up to 410 m³/h.
Heat recovery efficiency up to 94 %

Description

The VUT PB EC air handling units are the fully-featured ventilation units that ensure air filtration, fresh air supply and stale air extract.

Casing

Made of galvanised steel, internally filled with a 40 mm heat- and sound-insulating layer of mineral wool.

Filter

Built-in panel filters with filtration class F7 provide efficient supply air filtration.
Panel filters with filtration class G4 provide extract air

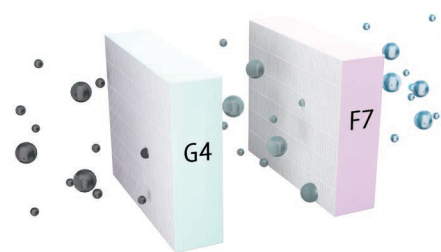

Fans

High-efficient electronically-commutated motors with an external rotor and backward curved blades.

Heat exchanger

The units are equipped with a high-efficient counter-flow polystyrene heat exchanger. In the cold season the extract air heat is captured and transferred to the supply air stream which reduces the ventilation-generated heat losses.

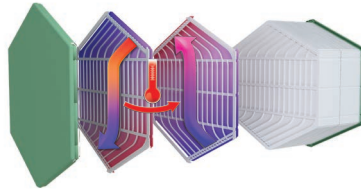

Freeze protection

To protect the heat exchanger from freezing in the cold season, the unit has a Frost Protection mode based on the temperature sensor readings. The Frost Protection mode is activated at an exhaust air temperature of +3 °C. After temperature increase the unit returns to the previous operation mode. In case of freezing danger, the supply fan is turned off in VUT 160/250/350 PB EC A14 units.

Three modes of freeze protection are available in VUT 160/250/350 PB EC A21 models:

- gradual reduction of the supply fan speed
- with the bypass
- with the electric preheater (available as an accessory).

Bypass

The units are equipped with a 100 % bypass which can be opened for summer cooling.

Control and automation

The **VUT PB EC A21** units are equipped with an integrated automation system.

The A21 controller enables integration of the unit into the **Smart Home System** or **BMS (Building Management Systems)**.

To control the unit via Wi-Fi, download the VENTS Home mobile app.



Google play

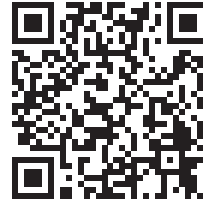

Download on the App Store



The **VUT PB EC A14** units are equipped with an integrated automation system and a wall-mounted control panel A14 with LED indication.





Mounting

The units are designed for ceiling or wall mounting (horizontal spigot orientation) in a position allowing condensate collection and removal into a special drain pan. The access for filter maintenance and replacement is available from the bottom panel.

Designation key

Series	Rated air flow [m ³ /h]	Installation type	Bypass	Motor type	Service side	Automation
VENTS VUT	160; 250; 350	P: suspended installation	B: bypass	EC: synchronous electronically commutated motor	L: left R: right	A14 A21

Control and automation

Functions	A21	A14
Wired remote control panel	Option (A22) 	A14 
Control via a wired remote LCD control panel	Option (A25) 	-
Wireless remote control panel	Option (A22 Wi-Fi) 	-
BMS	RS-485 Wi-Fi Ethernet MODBUS (RTU, TCP)	-
Vents Cloud Server service	+	-
Control via Wi-Fi using a mobile application	+	-
Freeze protection	+	+
Bypass	Auto + manual	Manual
Week-scheduled operation	+	-
Filter replacement indication	According to filter timer	According to filter timer
	According to filter clogging differential pressure switch readings	
Alarm indication	+	+
Speed selection	+	+
Timers	+	-
RH% sensor	Option	Option
CO ₂ sensor	Option	Option
VOC sensor	Option	Option
PM2.5 sensor	Option	Option
Boost mode	+	-
Fireplace mode	+	-
Preheater connection	Option	-
Reheater connection	Option	-
Cooler connection	Option	-
Fire alarm sensor	Option	Option
Minimum supply air temperature control	+	-

Overall dimensions

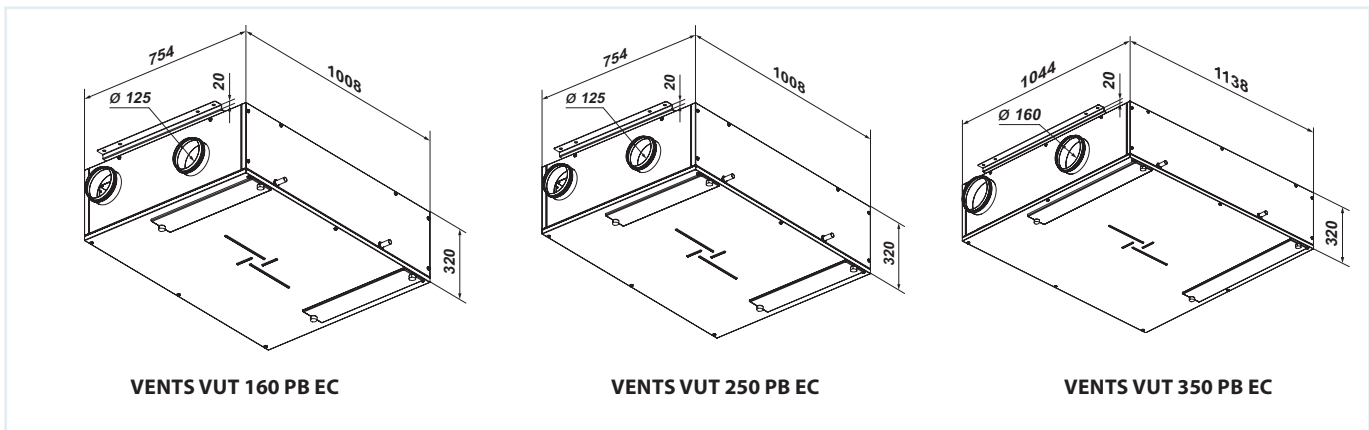

AIR HANDLING UNITS WITH HEAT RECOVERY

Technical data

	VUT 160 PB EC	VUT 250 PB EC	VUT 350 PB EC
Unit voltage [V/50 (60) Hz]		1~230	
Maximum unit power [W]	50	101	170
Maximum unit current [A]	0.4	0.8	1.3
Maximum air flow [m ³ /h]	190	270	410
RPM [min ⁻¹]	3770	4480	3200
Sound pressure level at 3 m distance [dBA]	26	28	34
Transported air temperature [°C]		-25...+40	
Casing material	Aluzinc steel		
Insulation	40 mm mineral wool		
Filter (extract/supply)	G4/F7		
Connected air duct diameter [mm]	Ø 125	Ø 125	Ø 160
Weight [kg]	48	48	70
Heat recovery efficiency [%]	82-94	80-98	80-91
Heat exchanger type	Counter-flow		
SEC class	A+	A	A
Heat exchanger material	Polystyrene		

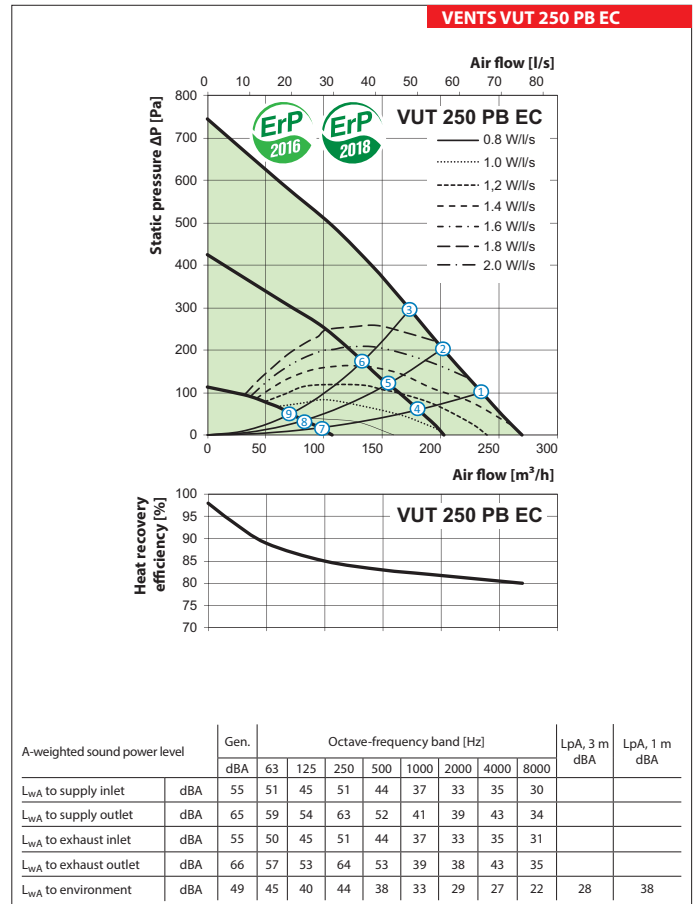
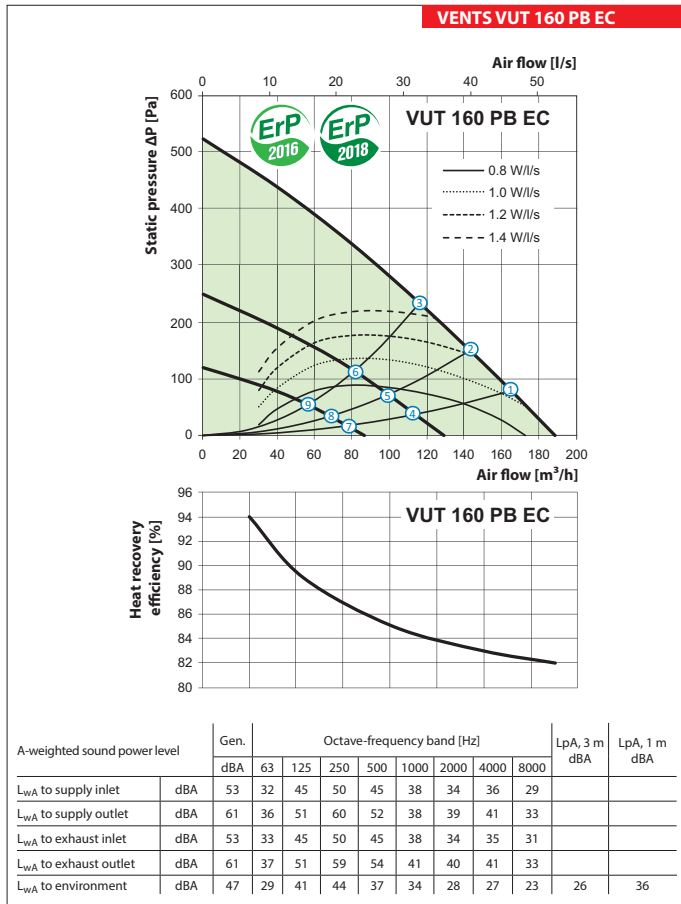

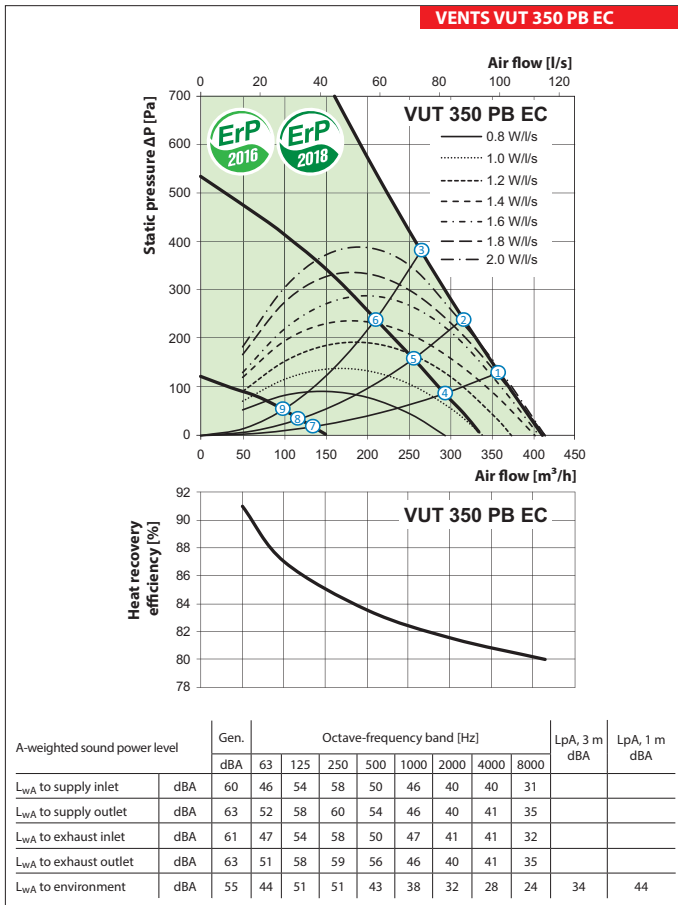

Point	Power [W]			Sound pressure level at 3 m (1 m) distance [dBA]		
	VUT 160 PB EC	VUT 250 PB EC	VUT 350 PB EC	VUT 160 PB EC	VUT 250 PB EC	VUT 350 PB EC
1	49	100	169	26 (36)	28 (38)	34 (44)
2	49	99	169	26 (36)	27 (37)	34 (44)
3	48	98	169	25 (35)	27 (37)	33 (43)
4	21	55	87	22 (32)	23 (33)	28 (38)
5	21	54	86	22 (32)	22 (32)	28 (38)
6	20	54	84	21 (31)	22 (32)	27 (37)
7	8	17	20	19 (29)	15 (25)	22 (32)
8	8	17	19	18 (28)	14 (24)	22 (32)
9	8	16	19	18 (28)	14 (24)	21 (31)

AIR HANDLING UNITS WITH HEAT RECOVERY

Accessories for air handling units

Model	G4 panel filter	F7 panel filter	Control panel	Control panel with Wi-Fi	LCD control panel	Indoor humidity sensor	Outdoor CO ₂ sensor with indication	Outdoor CO ₂ sensor
VUT 160 PB EC A14	SF 403x253x48 G4	SF 403x253x48 F7	-	-	-	HV2	CO2-1	CO2-2
VUT 160 PB EC A21			A22	A22 WiFi	A25			
VUT 250 PB EC A14			-	-	-			
VUT 250 PB EC A21			A22	A22 WiFi	A25			
VUT 350 PB EC A14			-	-	-			
VUT 350 PB EC A21			SF 603x253x48 G4	SF 603x253x48 F7	A22			

Model	Outdoor humidity sensor	VOC sensor (0-10 V)	CO ₂ sensor (0-10 V)	Humidity sensor (0-10 V)	Electric heater for preheating	Electric reheater	Hydraulic U-trap	Air damper	Electric actuator
VUT 160 PB EC A14	HR-S	-	-	-	-	-	SH-32	KRV 125	LF230
VUT 160 PB EC A21		DPWQ30600	DPWQ40200	DPWC11200	NKP-125	NKD-125			
VUT 250 PB EC A14		-	-	-	-	-			
VUT 250 PB EC A21		DPWQ30600	DPWQ40200	DPWC11200	NKP-125	NKD-125			
VUT 350 PB EC A14		-	-	-	-	-			
VUT 350 PB EC A21		DPWQ30600	DPWQ40200	DPWC11200	NKP-160	NKD-160			

Application options

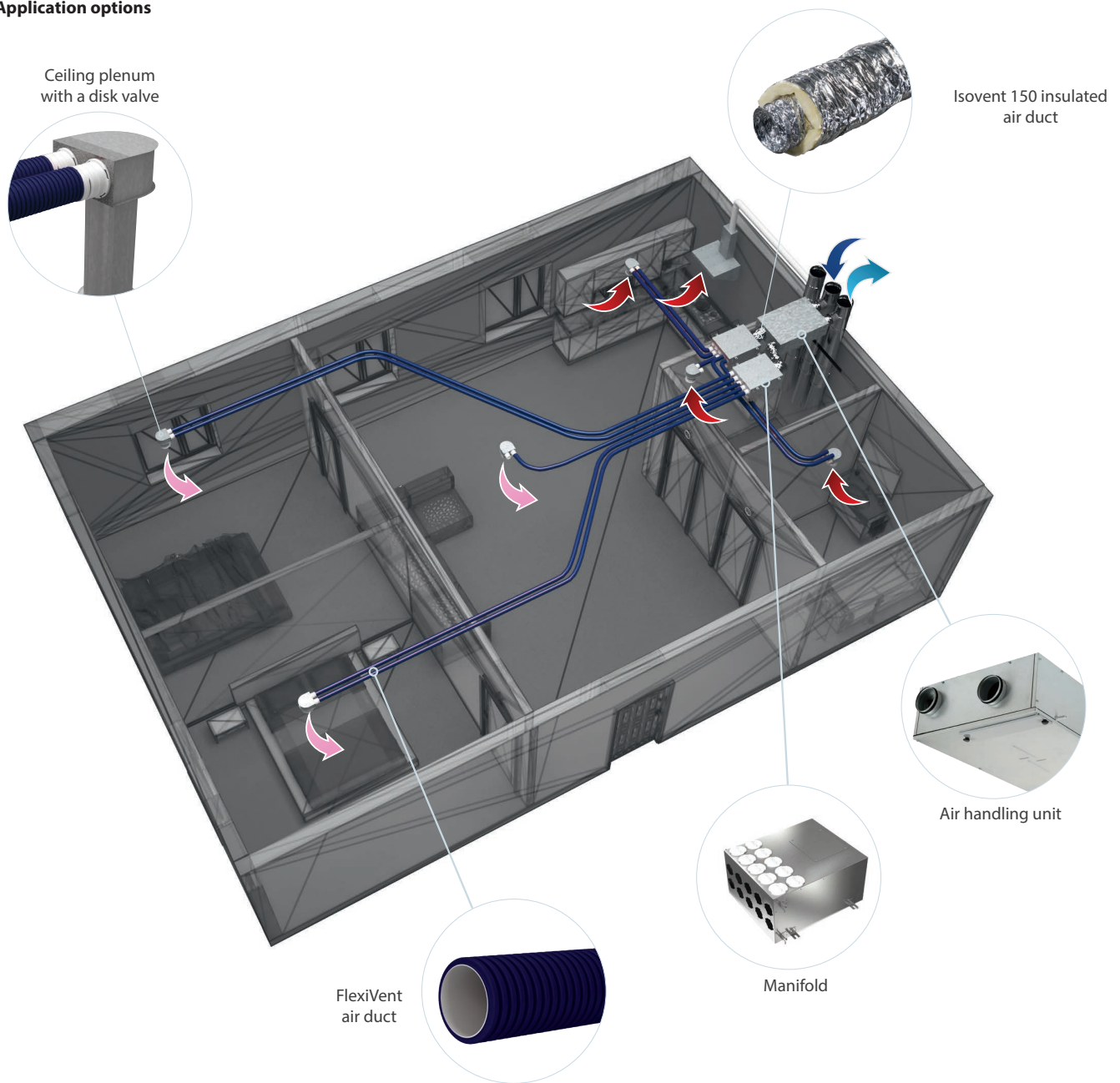

Series
VENTS VUT/VUE VB EC



Air handling units in heat- and sound-insulated casing.
Air flow up to **690 m³/h**.
Heat recovery efficiency up to **93 %**

Description

The air-handling units are the fully featured ventilation units with heat recovery for air filtration, fresh air supply and stale air extraction.

Casing

Made of high-quality polymer coated steel, internally filled with mineral wool layer for heat and sound insulation.

Filter

Supply and exhaust air flows are purified through panel filters with filtering class G4 and F7, respectively. Filters with G4 filtering class are used for supply and exhaust air purification in the **VUT/VUE 250 VB EC** units. F7 filter is available as an option for supply air filtration.

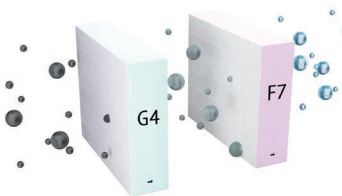

Fans

The units are equipped with high-efficient EC motors with an external rotor and a centrifugal impeller with backward curved blades.

Heat exchanger

The **VUT V(B) EC** units are equipped with a counter-flow polystyrene heat exchanger.

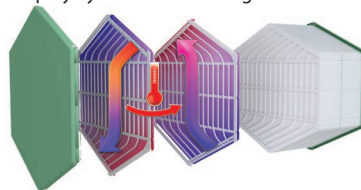

The **VUE V(B) EC** units are equipped with a counter-flow enthalpy heat exchanger.

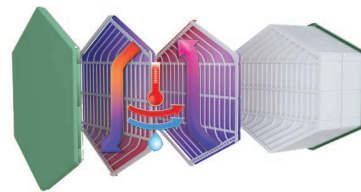

Bypass

The **VUT/VUE VB EC** units are equipped with a bypass for summer cooling.

Automation

The **VUT/VUE V(B) EC A21** units are equipped with a built-in automation system. The A21 controller allows integrating the unit into the Smart Home system or BMS (Building Management Systems). To control the unit via Wi-Fi, download the VENTS Home mobile app.

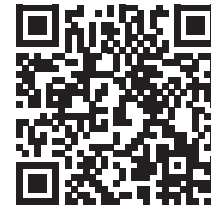

The **VUT/VUE V(B) EC A14** units have an integrated control system with a wall-mounted control panel A14 with a LED indication.

Freeze protection

In the **VUT/VUE 160/350/550 VB EC A21** units it is possible to connect a preheater to protect the unit from freezing.

The **VUT 250 VBE EC A21** unit is equipped with a built-in preheater for frost protection.

Mounting

The units are designed for wall or floor mounting. Access for maintenance of units and filters is possible from the right and left sides.

Overall dimensions

Model	Dimensions [mm]			
	Ø D	B	H	L
VUT/VUE 160 V EC	125	330	550	600
VUT/VUE 160 V1 EC	125	370	590	640
VUT/VUE 160 VB EC	125	330	580	600
VUT/VUE 160 V1B EC	125	370	620	640
VUT/VUE 250 VB EC L/R	160	560	970	560
VUT/VUE 350 VB EC	160	583	675	730
VUT/VUE 350 V1B EC	160	470	675	730
VUT/VUE 550 VB EC	200	720	675	823

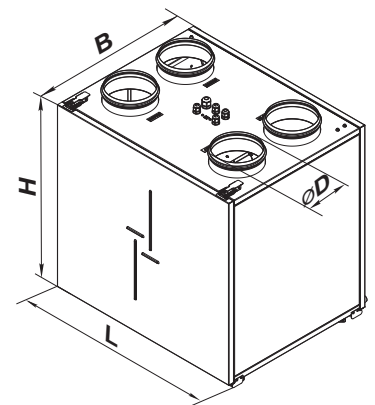





Designation key

Series	Rated air flow [m ³ /h]	Installation features	Casing design	Bypass	Motor type	Service side*	Control
VUT: ventilation with heat recovery VUE: ventilation with energy recovery	160, 250, 350, 550	V: vertical	- by default 1: casing modification	_ : without bypass B: with bypass	EC: synchronous electronically commutated motor	L: left R: right	A14 A21

* Only for VUT 250 VB EC L/R

Control and automation

Functions	A21	A14
Wired remote control panel	Option (A22) 	A14 
Control via a wired remote LCD control panel	Option (A25) 	-
Wireless remote control panel	Option (A22 Wi-Fi) 	-
BMS	RS-485 Wi-Fi Ethernet MODBUS (RTU, TCP)	-
Vents Cloud Server service	+	-
Control via Wi-Fi using a mobile application	+	-
Freeze protection	+	+
Bypass	Auto + manual	Manual
Week-scheduled operation	+	-
Filter replacement indication	By the filter timer	By the filter timer
	According to filter clogging differential pressure switch readings (only for VUT/VUE 550 VB EC A21)	
Alarm indication	+	+
Speed selection	+	+
Timer	+	-
RH% sensor	Option	Option
CO ₂ sensor	Option	Option
VOC sensor	Option	Option
PM2.5 sensor	Option	Option
Boost mode	+	-
Fireplace mode	+	-
Preheater connection	Option (built-in preheater in VUT 250 VBE EC units)	-
Reheater connection	Option	-
Cooler connection	Option	-
Fire alarm sensor	Option	Option
Minimum supply air temperature control	+	-

Unit design

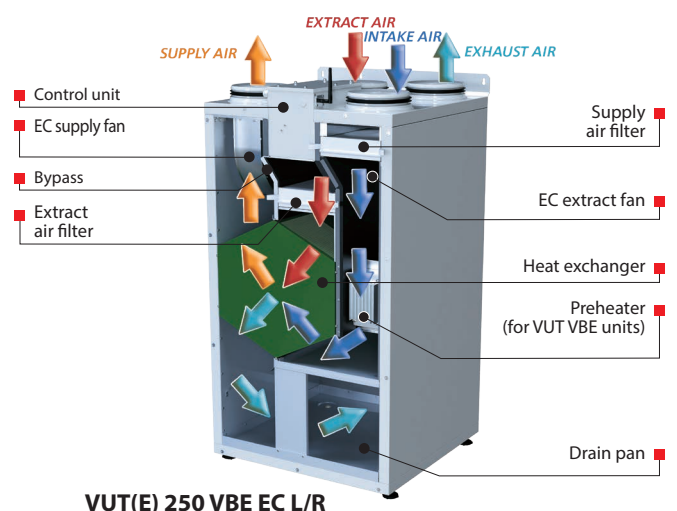
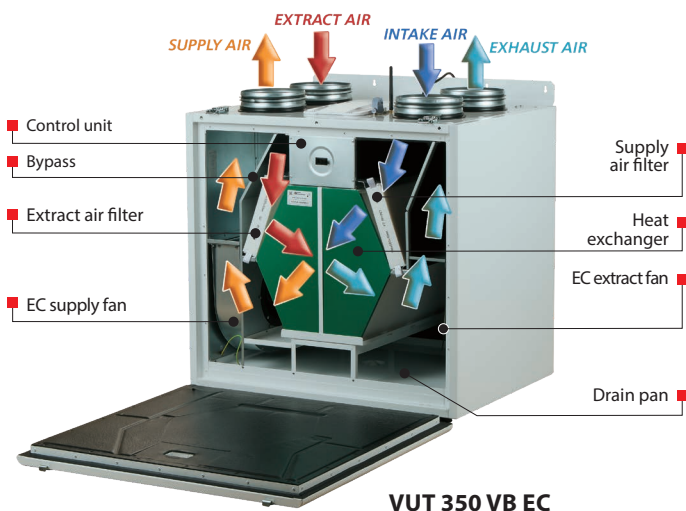

AIR HANDLING UNITS WITH HEAT RECOVERY

Technical data

	VUT 160 V EC	VUE 160 V EC	VUT 160 VB EC	VUE 160 VB EC	VUT 160 V1 EC	VUE 160 V1 EC	VUT 160 V1B EC	VUE 160 V1B EC
Unit voltage [V/50 (60) Hz]					1~230			
Maximum power [W]					57			
Maximum current [A]					0.5			
Maximum air flow [m ³ /h]					200			
RPM [min ⁻¹]					3770			
Sound pressure level at 3 m distance [dBA]	24				22			
Transported air temperature [°C]					-25...+40			
Casing material	painted steel							
Insulation	20 mm mineral wool				40 mm mineral wool			
Extract filter					G4			
Supply filter					F7 (G4 – option)			
Connected air duct diameter [mm]	Ø125							
Weight [kg]	34		36		42		44	
Heat recovery efficiency [%]	85–93	76–92	85–93	76–92	85–93	76–92	85–93	76–92
Heat exchanger type	counter-flow							
Heat exchanger material	polystyrene	enthalpy	polystyrene	enthalpy	polystyrene	enthalpy	polystyrene	enthalpy
Energy efficiency class for A14, A21	A+	A	A+	A	A+	A	A+	A

VENTS VUT/VUE V(B) EC

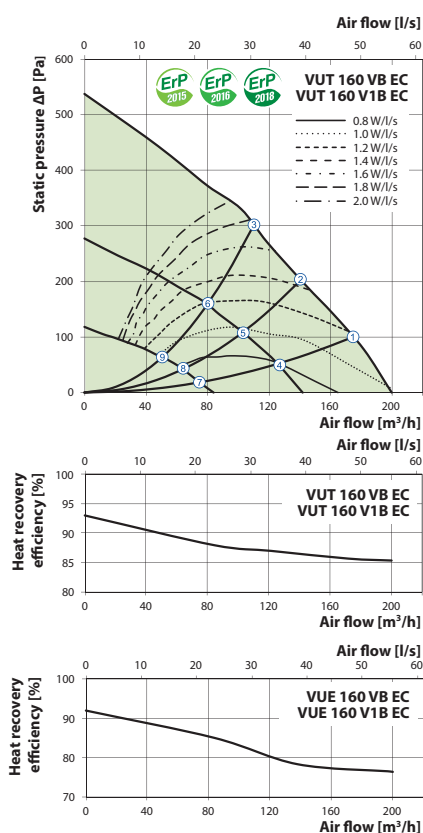

VUT 160 V EC, VUE 160 V EC, VUT 160 VB EC, VUE 160 VB EC

A-weighted sound power level	Gen. dBA	Octave frequency band [Hz]								LpA, 3 m dBA	LpA, 1 m dBA	
		63	125	250	500	1000	2000	4000	8000			
L _{WA} to supply air inlet	dBA	52	28	46	49	41	35	33	36	29		
L _{WA} to supply air outlet	dBA	60	32	52	58	47	37	36	41	35		
L _{WA} to exhaust air inlet	dBA	51	27	45	49	41	36	32	35	29		
L _{WA} to exhaust air outlet	dBA	60	31	50	59	48	36	36	41	32		
L _{WA} to environment	dBA	45	25	41	42	34	31	28	27	22	24	34

VUT 160 V1 EC, VUE 160 V1 EC, VUT 160 V1B EC, VUE 160 V1B EC

A-weighted sound power level	Gen. dBA	Octave frequency band [Hz]							LpA, 3 m dBA	LpA, 1 m dBA		
		63	125	250	500	1000	2000	4000			8000	
L _{WA} to supply air inlet	dBA	52	28	46	49	41	35	33	36	29		
L _{WA} to supply air outlet	dBA	60	32	52	58	47	37	36	41	35		
L _{WA} to exhaust air inlet	dBA	51	27	45	49	41	36	32	35	29		
L _{WA} to exhaust air outlet	dBA	60	31	50	59	48	36	36	41	32		
L _{WA} to environment	dBA	43	23	39	39	33	29	25	25	20	22	32

Calculation of air temperature at heat exchanger outlet:

$$t = t_{\text{outd}} + k_{\text{hr}} * (t_{\text{extr}} - t_{\text{outd}}) / 100,$$

where

t_{outd} is outdoor air temperature [°C]

t_{extr} is extract air temperature [°C]

k_{hr} is heat exchanger efficiency (according to the diagram) [%]

Technical data

	VUT 250 VB EC L/R	VUE 250 VB EC L/R	VUT 250 VBE EC L/R	VUE 250 VBE EC L/R
Unit voltage [V/50 (60) Hz]	1~230			
Maximum power [W]	180			
Maximum current [A]	1.37			
Electric heater power [W]	-		1400	
Electric heater current [A]	-		6.09	
Maximum unit power with an electric heater [W]	180		1580	
Maximum unit current (with an electric heater) [A]	1.37		7.46	
Maximum air flow [m ³ /h]	390			
RPM [min ⁻¹]	2600			
Sound pressure level at 3 m distance [dBA]	35			
Transported air temperature [°C]	-25...+40			
Casing material	painted steel			
Insulation	30 mm mineral wool			
Extract filter	G4			
Supply filter	G4 (F7 – option)			
Connected air duct diameter [mm]	Ø160			
Weight [kg]	66			
Heat recovery efficiency [%]	88–95	78–90	88–95	78–90
Heat exchanger type	counter-flow			
Heat exchanger material	polystyrene	enthalpy	polystyrene	enthalpy
Energy efficiency class for A14, A21	A+	A	A+	A

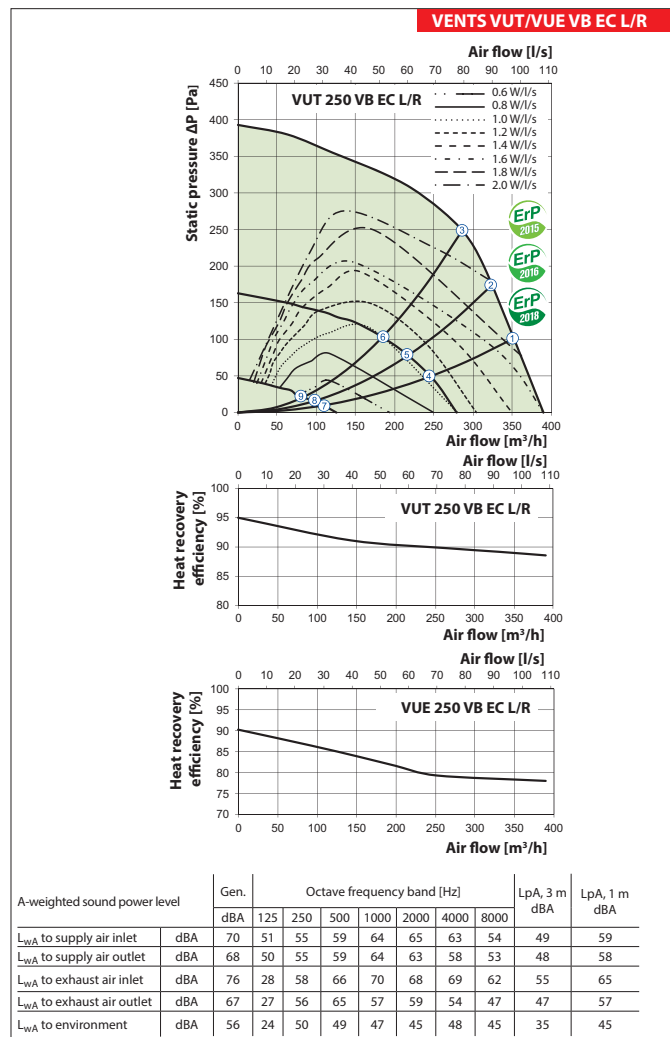

AIR HANDLING UNITS WITH HEAT RECOVERY

Technical data

	VUT 350 V1B EC	VUE 350 V1B EC	VUT 350 VB EC	VUE 350 VB EC
Unit voltage [V/50 (60) Hz]	1~230		1~230	
Maximum power [W]	169		178	
Maximum current [A]	1.3		1.4	
Maximum air flow [m ³ /h]	420		450	
RPM [min ⁻¹]	3200		3200	
Sound pressure level at 3 m distance [dBA]	28		28	
Transported air temperature [°C]	-25...+40		-25...+40	
Casing material	painted steel		painted steel	
Insulation	40 mm mineral wool		40 mm mineral wool	
Extract filter	G4		G4	
Supply filter	F7 (G4 – option)		F7 (G4 – option)	
Connected air duct diameter [mm]	Ø160		Ø160	
Weight [kg]	57		64	
Heat recovery efficiency [%]	85–92	74–91	85–92	73–91
Heat exchanger type	counter-flow		counter-flow	
Heat exchanger material	polystyrene	enthalpy	polystyrene	enthalpy
Energy efficiency class for A14, A21	A+	A	A+	A

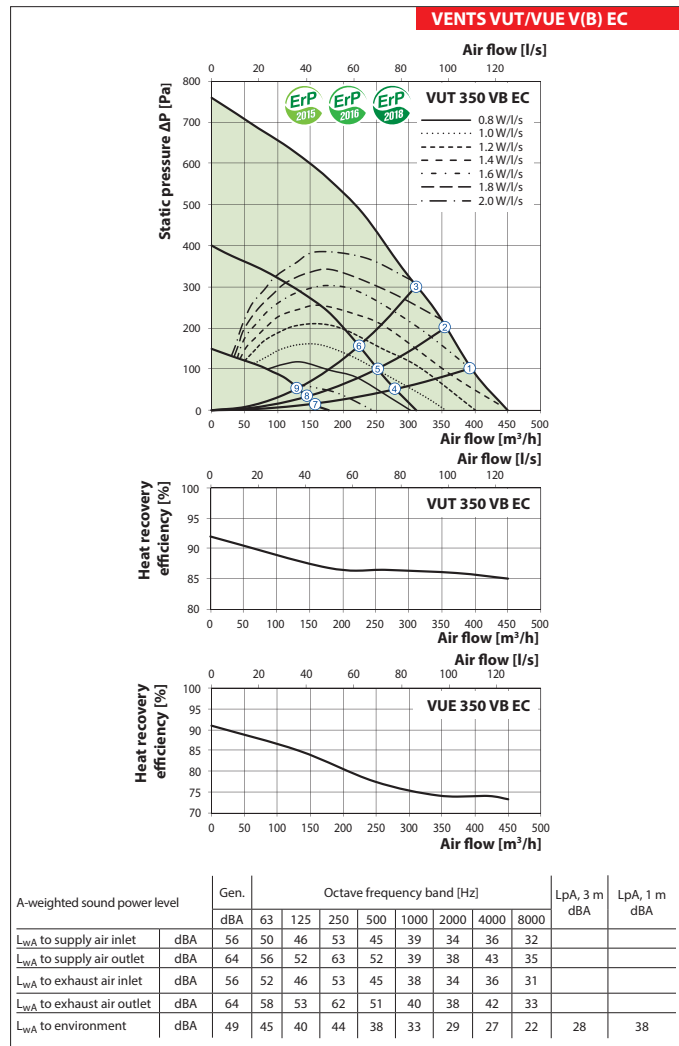
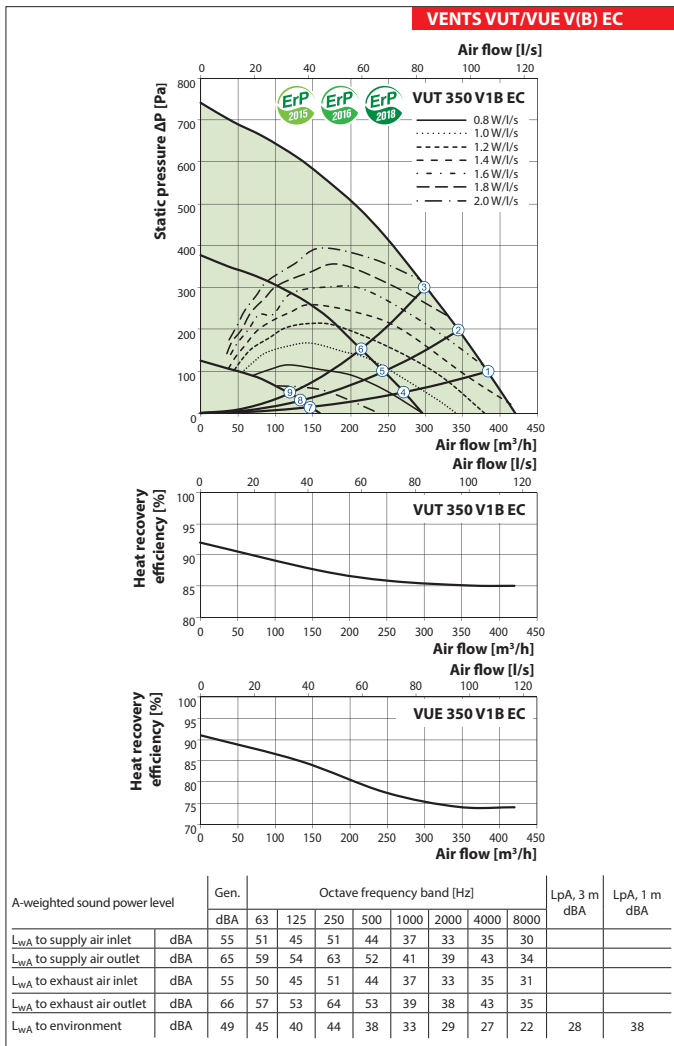

Technical data

	VUT 550 VB EC	VUE 550 VB EC
Unit voltage [V/50 (60) Hz]	1~230	
Maximum power [W]	337	
Maximum current [A]	2.4	
Maximum air flow [m³/h]	690	
RPM [min ⁻¹]	2860	
Sound pressure level at 3 m distance [dBA]	26	
Transported air temperature [°C]	-25...+40	
Casing material	painted steel	
Insulation	40 mm mineral wool	
Extract filter	G4	
Supply filter	F7 (G4 – option)	
Connected air duct diameter [mm]	Ø200	
Weight [kg]	82	
Heat recovery efficiency [%]	84–92	73–91
Heat exchanger type	counter-flow	
Heat exchanger material	polystyrene	enthalpy
Energy efficiency class for A14, A21	A+	A

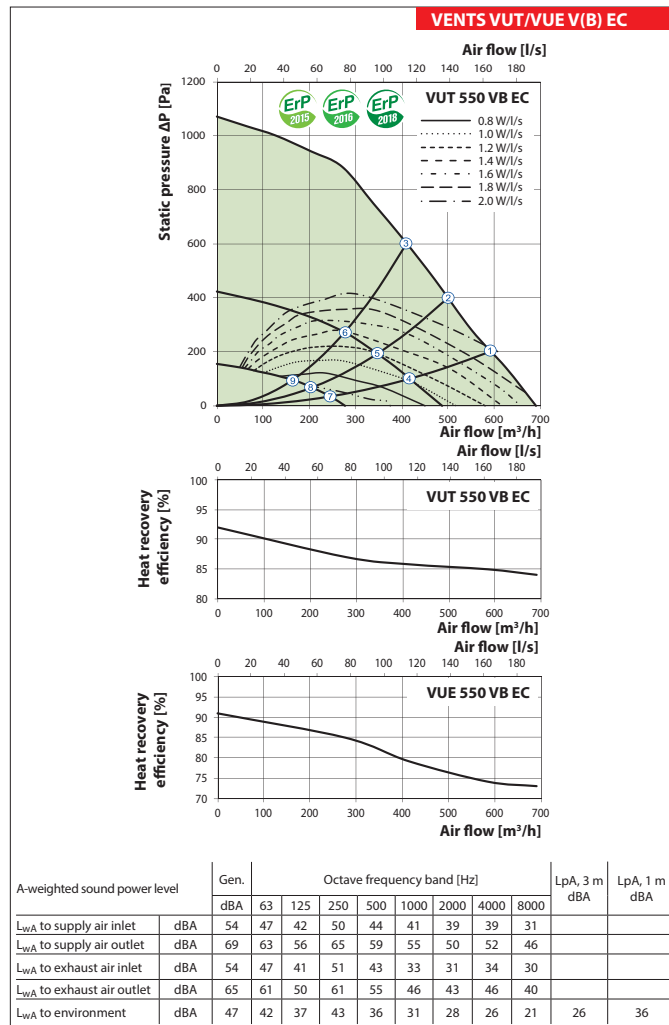

AIR HANDLING UNITS WITH HEAT RECOVERY

Technical data

VUT 350 VB EC				VUT 550 VB EC			
Outlet spigot configuration	Air flow [l/s]	Specific power input [W/l/s]	Heat exchange efficiency [%]	Outlet spigot configuration	Air flow [l/s]	Specific power input [W/l/s]	Heat exchange efficiency [%]
Kitchen + 1 additional room with high level of humidity	21	0.71	88	Kitchen + 1 additional room with high level of humidity	21	0.71	87
Kitchen + 2 additional rooms with high levels of humidity	29	0.64	88	Kitchen + 2 additional rooms with high levels of humidity	29	0.63	88
Kitchen + 3 additional rooms with high levels of humidity	37	0.68	87	Kitchen + 3 additional rooms with high levels of humidity	37	0.63	88
Kitchen + 4 additional rooms with high levels of humidity	45	0.76	86	Kitchen + 4 additional rooms with high levels of humidity	45	0.72	88
Kitchen + 5 additional rooms with high levels of humidity	53	0.86	86	Kitchen + 5 additional rooms with high levels of humidity	53	0.84	88
Kitchen + 6 additional rooms with high levels of humidity	61	1.07	85	Kitchen + 6 additional rooms with high levels of humidity	61	0.98	87
Kitchen + 7 additional rooms with high levels of humidity	69	1.26	85	Kitchen + 7 additional rooms with high levels of humidity	69	1.16	87

Point	Power [W]				
	VUT 160 V EC VUT 160 VB EC VUT 160 V1 EC VUT 160 V1B EC VUE 160 V EC VUE 160 VB EC VUE 160 V1 EC VUE 160 V1B EC	VUT 250 VB EC L/R VUE 250 VB EC L/R	VUT 350 V1B EC VUE 350 V1B EC	VUT 350 VB EC VUE 350 VB EC	VUT 550 VB EC VUE 550 VB EC
1	57	180	168	177	337
2	56	179	166	175	337
3	54	168	162	170	337
4	28	63	65	71	118
5	27	57	64	71	113
6	26	52	62	69	107
7	14	15	18	21	34
8	13	15	17	21	66
9	13	14	17	21	32

Point	Sound pressure level at 3 m distance [dBA]				
	VUT 160 V EC VUT 160 VB EC VUT 160 V1 EC VUT 160 V1B EC VUE 160 V EC VUE 160 VB EC VUE 160 V1 EC VUE 160 V1B EC	VUT 250 VB EC L/R VUE 250 VB EC L/R	VUT 350 V1B EC VUE 350 V1B EC	VUT 350 VB EC VUE 350 VB EC	VUT 550 VB EC VUE 550 VB EC
1	24 (34)	35 (45)	28 (38)	28 (38)	26 (36)
2	23 (33)	35 (45)	27 (37)	27 (37)	26 (36)
3	23 (33)	35 (45)	27 (37)	27 (37)	25 (35)
4	20 (30)	24 (34)	23 (33)	23 (33)	24 (34)
5	20 (30)	24 (34)	22 (32)	22 (32)	24 (34)
6	20 (30)	23 (33)	22 (32)	22 (32)	22 (32)
7	13 (23)	18 (27)	15 (25)	15 (25)	15 (25)
8	13 (23)	17 (27)	14 (24)	14 (24)	14 (24)
9	13 (23)	17 (27)	14 (24)	14 (24)	13 (23)

Application options

Ventilation hood



Ceiling connector with a disk valve



Isovent 150 insulated air duct

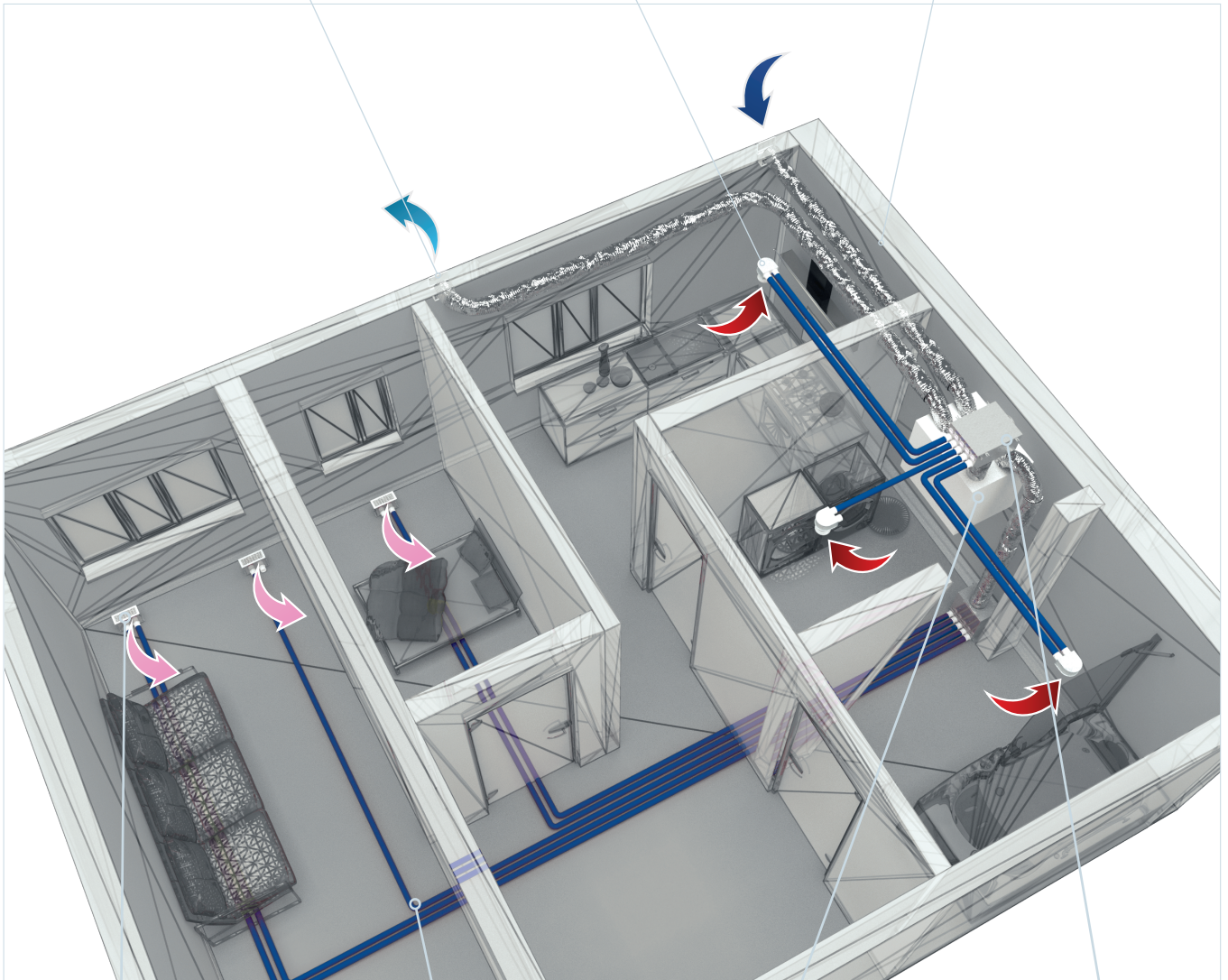

Floor plenum with a grille

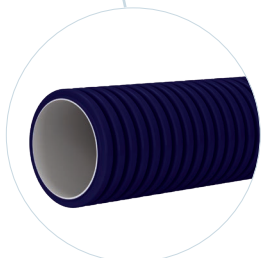

FlexiVent air duct





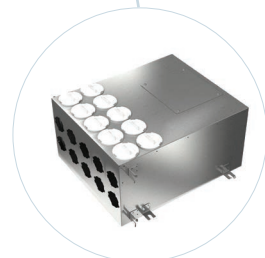





Air handling unit



Collector

AIR HANDLING UNITS WITH HEAT RECOVERY

Accessories for air handling units

Model	G4 panel filter		F7 panel filter		LCD control panel	Control panel	Control panel with Wi-Fi	Indoor humidity sensor	CO ₂ sensor with indication	CO ₂ sensor	Humidity sensor
											
VUT 160 V EC A14			-	-	-						
VUE 160 V EC A14			-	-	-						
VUT 160 VB EC A21			A25	A22	A22 Wi-Fi						
VUT 160 VB EC A14			-	-	-						
VUE 160 VB EC A21			A25	A22	A22 Wi-Fi						
VUE 160 VB EC A14	SF 285x195x10	SF 285x195x10	-	-	-						
VUT 160 V1 EC A14	G4	F7	-	-	-						
VUE 160 V1 EC A14			-	-	-						
VUT 160 V1B EC A21			A25	A22	A22 Wi-Fi						
VUT 160 V1B EC A14			-	-	-						
VUE 160 V1B EC A21			A25	A22	A22 Wi-Fi						
VUE 160 V1B EC A14			-	-	-						
VUT 250 VB EC A21			A25	A22	A22 Wi-Fi						
VUT 250 VB EC A14	SF 340x170x48	SF 340x170x48	-	-	-						
VUE 250 VB EC A21	G4	F7	A25	A22	A22 Wi-Fi	HV2	CO2-1	CO2-2	HR-S		
VUE 250 VB EC A14			-	-	-						
VUT 350 V1B EC A21			A25	A22	A22 Wi-Fi						
VUT 350 V1B EC A14	SF 384x196x40	SF 384x196x40	-	-	-						
VUE 350 V1B EC A21	G4	F7	A25	A22	A22 Wi-Fi						
VUE 350 V1B EC A14			-	-	-						
VUT 350 VB EC A21			A25	A22	A22 Wi-Fi						
VUT 350 VB EC A14	SF 500x196x40	SF 500x196x40	-	-	-						
VUE 350 VB EC A21	G4	F7	A25	A22	A22 Wi-Fi						
VUE 350 VB EC A14			-	-	-						
VUT 550 VB EC A21			A25	A22	A22 Wi-Fi						
VUT 550 VB EC A14	SF 630x198x40	SF 630x198x40	-	-	-						
VUE 550 VB EC A21	G4	F7	A25	A22	A22 Wi-Fi						
VUE 550 VB EC A14			-	-	-						

Model	VOC sensor (0-10 V)	CO ₂ sensor (0-10 V)	Humidity sensor (0-10 V)	Kitchen hood	Electric preheater	Electric reheater	Hydraulic U-trap	Air damper	Electric actuator	Summer block	
VUT 160 V EC A14	-	-	-	KH-1	-	-	SH-32	KRV 125			
VUE 160 V EC A14	-	-	-		-	-	-				VL C6 366/285
VUT 160 VB EC A21	DPWQ30600	DPWQ40200	DPWC11200		NKP-125 A21 V.2	NKD-125 A21 V.2	SH-32				
VUT 160 VB EC A14	-	-	-		-	-	-				
VUE 160 VB EC A21	DPWQ30600	DPWQ40200	DPWC11200		NKP-125 A21 V.2	NKD-125 A21 V.2	-				
VUE 160 VB EC A14	-	-	-		-	-	-				
VUT 160 V1 EC A14	-	-	-		-	-	SH-32				
VUE 160 V1 EC A14	-	-	-		-	-	-				VL C6 366/285
VUT 160 V1B EC A21	DPWQ30600	DPWQ40200	DPWC11200		NKP-125 A21 V.2	NKD-125 A21 V.2	SH-32				
VUT 160 V1B EC A14	-	-	-		-	-	-				
VUE 160 V1B EC A21	DPWQ30600	DPWQ40200	DPWC11200		NKP-125 A21 V.2	NKD-125 A21 V.2	-				
VUE 160 V1B EC A14	-	-	-		-	-	-				
VUT 250 VB EC A21	DPWQ30600	DPWQ40200	DPWC11200	-	NKD-160 A21 V.2	SH-32	KRV 160				
VUT 250 VB EC A14	-	-	-	-	-	-					
VUE 250 VB EC A21	DPWQ30600	DPWQ40200	DPWC11200	-	NKD-160 A21 V.2	-					
VUE 250 VB EC A14	-	-	-	-	-	-					
VUT 350 V1B EC A21	DPWQ30600	DPWQ40200	DPWC11200	NKP-160 A21 V.2	NKD-160 A21 V.2	SH-32					
VUT 350 V1B EC A14	-	-	-	-	-	-					
VUE 350 V1B EC A21	DPWQ30600	DPWQ40200	DPWC11200	NKP-160 A21 V.2	NKD-160 A21 V.2	-					
VUE 350 V1B EC A14	-	-	-	-	-	-					
VUT 350 VB EC A21	DPWQ30600	DPWQ40200	DPWC11200	NKP-160 A21 V.2	NKD-160 A21 V.2	SH-32					
VUT 350 VB EC A14	-	-	-	-	-	-					
VUE 350 VB EC A21	DPWQ30600	DPWQ40200	DPWC11200	NKP-160 A21 V.2	NKD-160 A21 V.2	-					
VUE 350 VB EC A14	-	-	-	-	-	-					
VUT 550 VB EC A21	DPWQ30600	DPWQ40200	DPWC11200	NKP-200 A21 V.2	NKD-200 A21 V.2	SH-32	KRV 200				
VUT 550 VB EC A14	-	-	-	-	-	-					
VUE 550 VB EC A21	DPWQ30600	DPWQ40200	DPWC11200	NKP-200 A21 V.2	NKD-200 A21 V.2	-					
VUE 550 VB EC A14	-	-	-	-	-	-					

Series

VENTS VUT/VUE HB EC
VENTS VUT/VUE HBE EC



Heat recovery air handling units in sound- and heat-insulated casings
Air flow up to **830 m³/h**
Heat recovery efficiency up to **98 %**

Description

The VUT/VUE HB EC and VUT/VUE HBE EC air handling units are the fully-featured ventilation units that ensure air filtration, fresh air supply and stale air extract. Used in ventilation and air conditioning systems in commercial, office and other public or industrial premises that require an economical solution and a controlled ventilation system.

Modifications

The **VUT HB EC** model is equipped with a counter-flow heat exchanger made of polystyrene. The **VUT HBE EC** model is equipped with a counter-flow heat exchanger made of polystyrene and an electric heater.

The **VUE HB EC** model is equipped with with an enthalpy counter-flow heat exchanger.

The **VUE HBE EC** model is equipped with an enthalpy counter-flow heat exchanger and an electric heater.

Casing

Made of aluzinc steel, internally filled with a 40 mm mineral wool heat- and sound-insulating layer.

Filter

Two built-in panel filters with filtration class G4 and F7 provide efficient supply air filtration. The G4 panel filter is used for extract air cleaning.

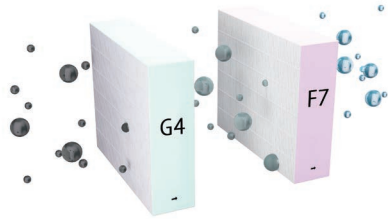

Fans

High-efficient electronically-commutated motors with external rotor. The 700 size units are equipped with fans with backward curved blades.

Heat exchanger

The VUT units are equipped with a counter-flow polystyrene heat exchanger.

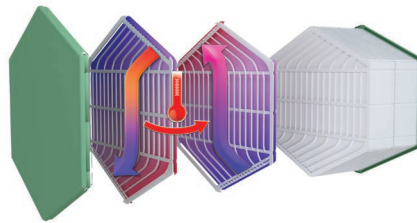

The VUE units are equipped with enthalpy counter-flow heat exchanger.

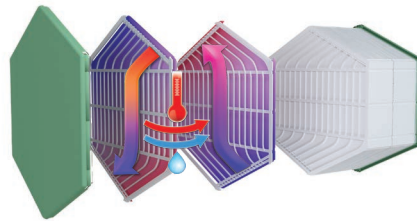

Heater

The **VUT/VUE HBE EC** units are equipped with an electric heater for additional heating of supply air downstream of the heat exchanger.

Bypass

The unit is equipped for summer cooling. If the unit is equipped with an electric heater, the bypass is used for freeze protection of the heat exchanger.

Automation

The **VUT/VUE HB(E) EC A21** units are equipped with an integrated control system. The A21 control-

ler allows integrating the unit into the Smart Home system or BMS (Building Management Systems). To control the unit using a mobile application via Wi-Fi, you need to download the VENTS Home mobile application.

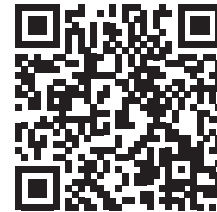

Google play



Download on the App Store



Freeze protection

Freeze protection in the **VUT/VUE HBE EC A21** units is achieved by a bypass. A preheater can be additionally installed in the **VUT/VUE HB EC A21** units for freeze protection.





Mounting

The unit is designed for suspended or floor mounting. Access for service and filter cleaning from the front panel. During mounting stage the front and the back panels can be reversed providing either left-handed or right-handed unit mounting.

Designation key

Series	Rated air flow [m³/h]	Spigot orientation	Bypass	Heater type	Motor type	Automation
VUT: ventilation with heat recovery VUE: ventilation with energy recovery	300; 400; 700	H: horizontal	B: bypass	_: without a heater E: electric heater	EC: synchronous electronically commutated motor	A21

Control and automation

Functions	A21
Control via Wi-Fi using a mobile application	+
Control via a wired remote control panel	option (A22) 
Wired remote LCD control panel	option (A25) 
Control via a wireless remote control panel	option (A22 Wi-Fi) 
BMS	RS-485 Wi-Fi Ethernet MODBUS (RTU, TCP)
Service Vents Cloud Server	+
Speed selection	+
Filter replacement indication	according to hour meter readings according to filter clogging differential pressure switch readings
Alarm indication	full alarm description in the mobile application
Week-scheduled operation	+
Bypass	automatic manual
Timers	+
Boost mode	+
Fireplace mode	+
Freeze protection	through cyclic stops of the supply fan through preheating (option) using a bypass
Reheater connection	option
Cooler connection	option
Minimum supply air temperature control	+
Humidity control	option
CO ₂ controller	option
VOC controller	option
PM2.5 control	option
Fire alarm sensor connection	option

*Option. The functionality is available when you purchase the appropriate accessory.

Overall dimensions

Model	Dimensions [mm]								
	Ø D	B	B1	B2	H	H1	H2	L	L1
VUT/VUE 300 HB(E) EC	157	566	190	189	479	193	118	1083	1180
VUT/VUE 400 HB(E) EC	197	682	248	217	504	201	141	1094	1191
VUT/VUE 700 HB(E) EC	247	866	274	296	601	234	166	1282	1379

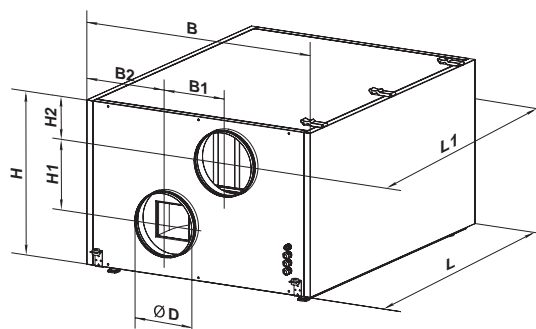

AIR HANDLING UNITS WITH HEAT RECOVERY

Technical data

	VUT 300 HB EC A21	VUT 300 HBE EC A21	VUE 300 HB EC A21	VUE 300 HBE EC A21
Unit voltage [V/50 (60) Hz]	1~230			
Maximum unit power (without a heater) [W]	182		182	
Maximum unit current (without a heater) [A]	1.4		1.4	
Electric heater power [W]	-	2800	-	2800
Electric heater current [A]	-	12.2	-	12.2
Maximum unit power with an electric heater [W]	182	2982	182	2982
Maximum unit current (with an electric heater) [A]	1.4	13.6	1.4	13.6
Maximum air flow [m ³ /h]	380		380	
RPM [min ⁻¹]	2100		2100	
Sound pressure level at 3 m distance [dBA]	24		24	
Maximum transported air temperature [°C]	-25...+40			
Casing material	galvanized steel			
Insulation	40 mm mineral wool			
Filter: extract	G4			
Filter: supply	G4+F7			
Connected air duct diameter [mm]	Ø160		Ø160	
Weight [kg]	63.1	64.3	63.1	64.3
Heat recovery efficiency	from 80 up to 98 %		from 74 up to 89 %	
Heat exchanger type	counter-flow			
Heat exchanger material	polystyrene		enthalpy	
SEC class	A+	A+	A	A

VENTS VUT/VUE HB(E) EC

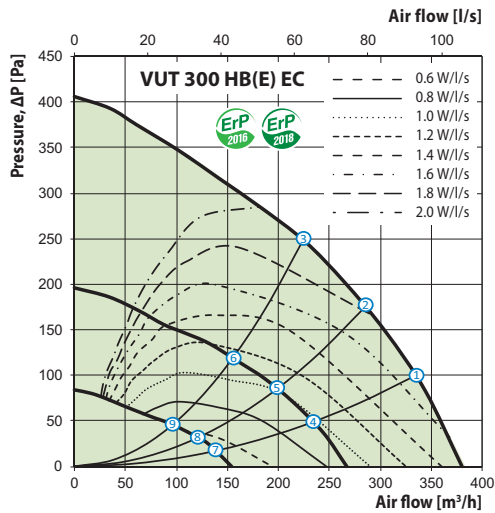

Point	Unit power (without a heater) [W]	Sound pressure level at 3 m (1 m) distance [dBA]
	VUT/VUE 300 HB(E) EC	VUT/VUE 300 HB(E) EC
1	155	24 (34)
2	143	23 (33)
3	119	23 (33)
4	61	20 (30)
5	56	20 (30)
6	46	20 (30)
7	20	13 (23)
8	19	13 (23)
9	18	13 (23)

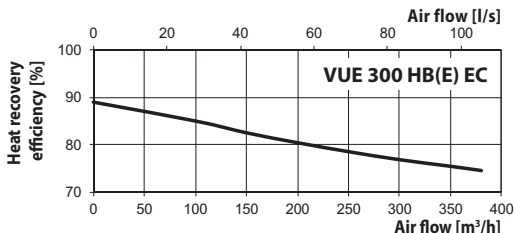
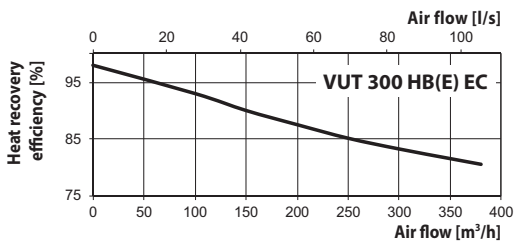

A-weighted sound power level	Gen. dBA	Octave-frequency band [Hz]								LpA, 3 m dBA	LpA, 1 m dBA	
		63	125	250	500	1000	2000	4000	8000			
L _{WA} to supply air inlet	dBA	67	50	55	56	62	60	62	56	50		
L _{WA} to supply air outlet	dBA	53	42	47	46	46	44	39	29	21		
L _{WA} to exhaust air inlet	dBA	68	56	54	61	62	59	61	56	50		
L _{WA} to exhaust air outlet	dBA	55	42	47	51	48	46	43	31	22		
L _{WA} surrounding	dBA	45	34	35	40	39	32	36	31	27	24	34

	VUT 400 HB EC A21	VUT 400 HBE EC A21	VUE 400 HB EC A21	VUE 400 HBE EC A21
Unit voltage [V/50 (60) Hz]	1~230			
Maximum unit power (without a heater) [W]	289		289	
Maximum unit current (without a heater) [A]	2.1		2.1	
Electric heater power [W]	-	2800	-	2800
Electric heater current [A]	-	12.2	-	12.2
Maximum unit power with an electric heater [W]	289	3089	289	3089
Maximum unit current (with an electric heater) [A]	2.1	14.3	2.1	14.3
Maximum air flow [m ³ /h]	540		540	
RPM [min ⁻¹]	2600		2600	
Sound pressure level at 3 m distance [dBA]	27		27	
Maximum transported air temperature [°C]	-25...+40			
Casing material	galvanized steel			
Insulation	40 mm mineral wool			
Filter: extract	G4			
Filter: supply	G4+F7			
Connected air duct diameter [mm]	Ø200		Ø200	
Weight [kg]	74.8	76	74.8	76
Heat recovery efficiency	from 84 up to 98 %		from 78 up to 89 %	
Heat exchanger type	counter-flow			
Heat exchanger material	polystyrene		enthalpy	
SEC class	A+	A+	A	A

VENTS VUT/VUE HB(E) EC

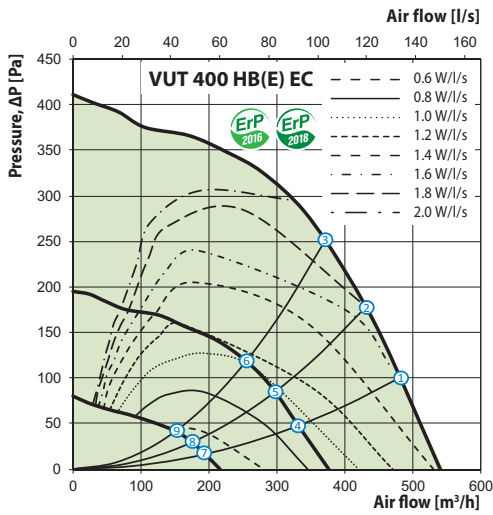

Point	Unit power (without a heater) [W]	Sound pressure level at 3 m (1 m) distance [dBA]
	VUT/VUE 400 HB(E) EC	VUT/VUE 400 HB(E) EC
1	240	27 (37)
2	215	26 (36)
3	196	26 (36)
4	89	21 (31)
5	80	21 (31)
6	72	20 (30)
7	27	19 (29)
8	26	19 (29)
9	24	17 (27)

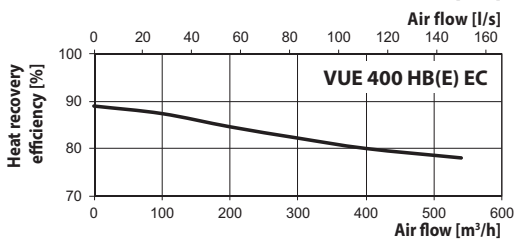
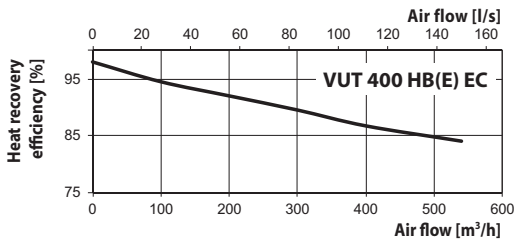

A-weighted sound power level	Gen. dBA	Octave-frequency band [Hz]							LpA, 3 m dBA	LpA, 1 m dBA		
		63	125	250	500	1000	2000	4000			8000	
L _{WA} to supply air inlet	dBA	71	52	57	57	68	64	64	59	53		
L _{WA} to supply air outlet	dBA	56	44	49	47	52	47	41	31	24		
L _{WA} to exhaust air inlet	dBA	70	52	56	60	66	62	64	60	53		
L _{WA} to exhaust air outlet	dBA	58	39	49	52	53	49	46	35	24		
L _{WA} surrounding	dBA	48	32	37	40	45	36	38	35	30	27	37

AIR HANDLING UNITS WITH HEAT RECOVERY

Technical data

	VUT 700 HB EC A21	VUT 700 HBE EC A21	VUE 700 HB EC A21	VUE 700 HBE EC A21
Unit voltage [V/50 (60) Hz]	1~230			
Maximum unit power (without a heater) [W]	336		336	
Maximum unit current (without a heater) [A]	2.4		2.4	
Electric heater power [W]	-	3600	-	3600
Electric heater current [A]	-	15.6	-	15.6
Maximum unit power with an electric heater [W]	336	3936	336	3936
Maximum unit current (with an electric heater) [A]	2.4	18.0	2.4	18.0
Maximum air flow [m³/h]	830		830	
RPM [min⁻¹]	3200		3200	
Sound pressure level at 3 m distance [dBA]	31		31	
Maximum transported air temperature [°C]	-25...+40			
Casing material	galvanized steel			
Insulation	40 mm mineral wool			
Filter: extract	G4			
Filter: supply	G4+F7			
Connected air duct diameter [mm]	Ø250		Ø250	
Weight [kg]	107	108.4	107	108.4
Heat recovery efficiency	from 80 up to 98 %		from 74 up to 89 %	
Heat exchanger type	counter-flow			
Heat exchanger material	polystyrene		enthalpy	
SEC class	A+	A+	A	A



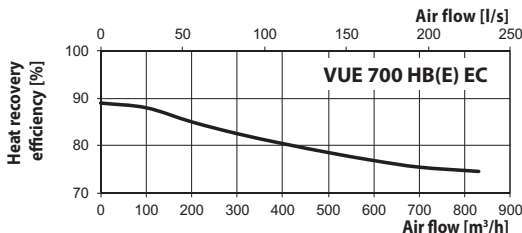
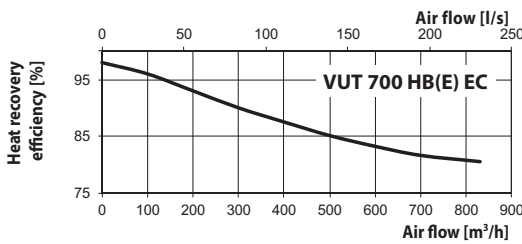
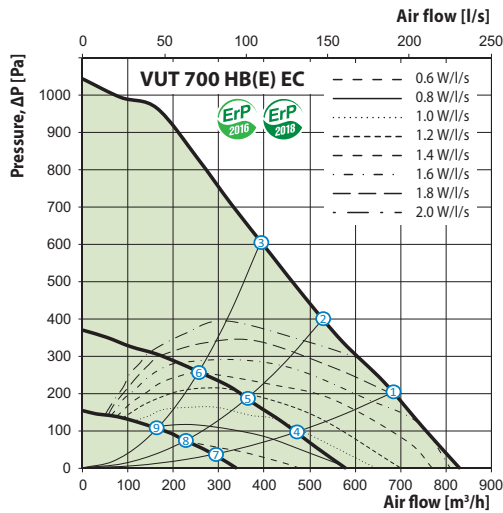









VENTS VUT/VUE HB(E) EC



Point	Unit power (without a heater) [W]	Sound pressure level at 3 m (1 m) distance [dBA]
	VUT/VUE 700 HB(E) EC	VUT/VUE 700 HB(E) EC
1	336	31 (41)
2	336	30 (40)
3	336	29 (39)
4	123	25 (35)
5	115	25 (35)
6	96	24 (34)
7	41	23 (33)
8	38	23 (33)
9	36	20 (30)

A-weighted sound power level	Gen. dBA	Octave-frequency band [Hz]								LpA, 3 m dBA	LpA, 1 m dBA	
		63	125	250	500	1000	2000	4000	8000			
L _{WA} to supply air inlet	dBA	76	56	61	61	73	69	69	64	57		
L _{WA} to supply air outlet	dBA	60	49	53	52	56	51	44	34	26		
L _{WA} to exhaust air inlet	dBA	74	56	60	65	70	66	68	64	56		
L _{WA} to exhaust air outlet	dBA	61	42	53	56	56	52	49	37	25		
L _{WA} surrounding	dBA	51	35	40	43	49	39	40	37	32	31	41

Accessories for air handling units

Model	G4 panel filter	F7 panel filter	LCD control panel	Control panel	Wi-Fi controllable control	Humidity sensor (0-10 V)	CO ₂ sensor	CO ₂ sensor with indication	Humidity sensor	VOC sensor (0-10V)	CO ₂ sensor (0-10V)	Humidity sensor (0-10V)
												
VUT/VUE 300 HB EC A21	SF	SF	A25	A22	A22 Wi-Fi	HV2	CO2-1	CO2-2	HR-S	DPWQ 30600	DPWQ 40200	DPWC 11200
VUT/VUE 300 HBE EC A21	484x178x48 G4	484x178x48 F7								DPWQ 30600	DPWQ 40200	DPWC 11200
VUT/VUE 400 HB EC A21	SF	SF								DPWQ 30600	DPWQ 40200	DPWC 11200
VUT/VUE 400 HBE EC A21	600x205x48 G4	600x205x48 F7										
VUT/VUE 700 HB EC A21	SF	SF	A25	A22	A22 Wi-Fi					DPWQ 30600	DPWQ 40200	DPWC 11200
VUT/VUE 700 HBE EC A21	784x253x48 G4	784x253x48 F7								DPWQ 30600	DPWQ 40200	DPWC 11200

Model	Electric reheater	Electric heater for preheating	Silencers		Back valves	Air dampers	Clamps	Drain pump	Electric actuator	
										
VUT/VUE 300 HB EC A21	NKD 160	NKP 160	SR 160	SRF 160	KOM 160	KRV 160	C 160	DN-2	LF230	TF230
VUT/VUE 300 HBE EC A21	-	NKP 160	600/900/1200	600/900/1200	KOM 160	KRV 160	C 160			
VUT/VUE 400 HB EC A21	NKD 200	NKP 200	SR 200	SRF 200	KOM 200	KRV 200	C 200			
VUT/VUE 400 HBE EC A21	-	NKP 200	600/900/1200	600/900/1200	KOM 200	KRV 200	C 200			
VUT/VUE 700 HB EC A21	NKD 250	NKP 250	SR 250	SRF 250	KOM 250	KRV 250	C 250			
VUT/VUE 700 HBE EC A21	-	NKP 250	600/900/1200	600/900/1200	KOM 250	KRV 250	C 250			

Unit design

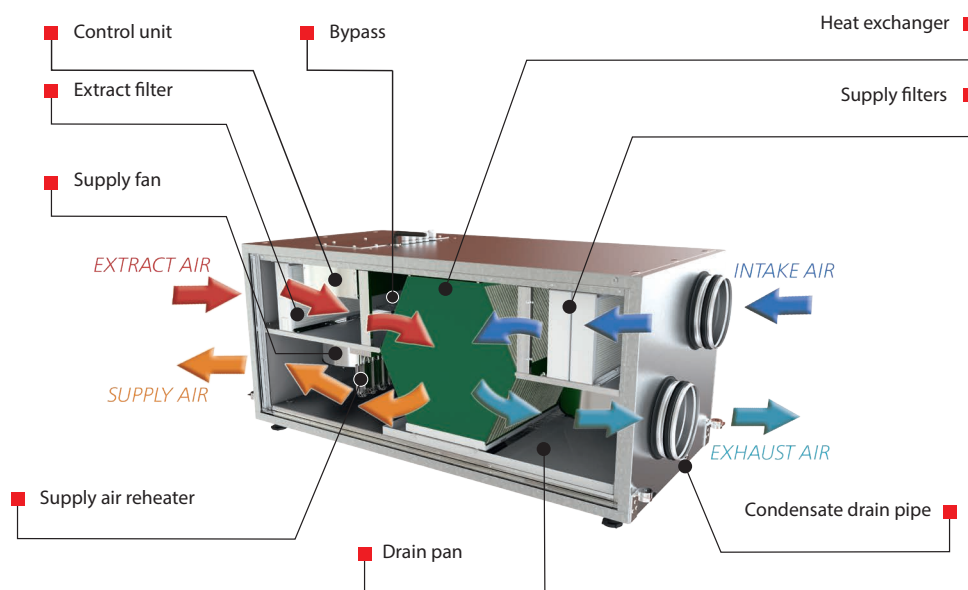

Application options

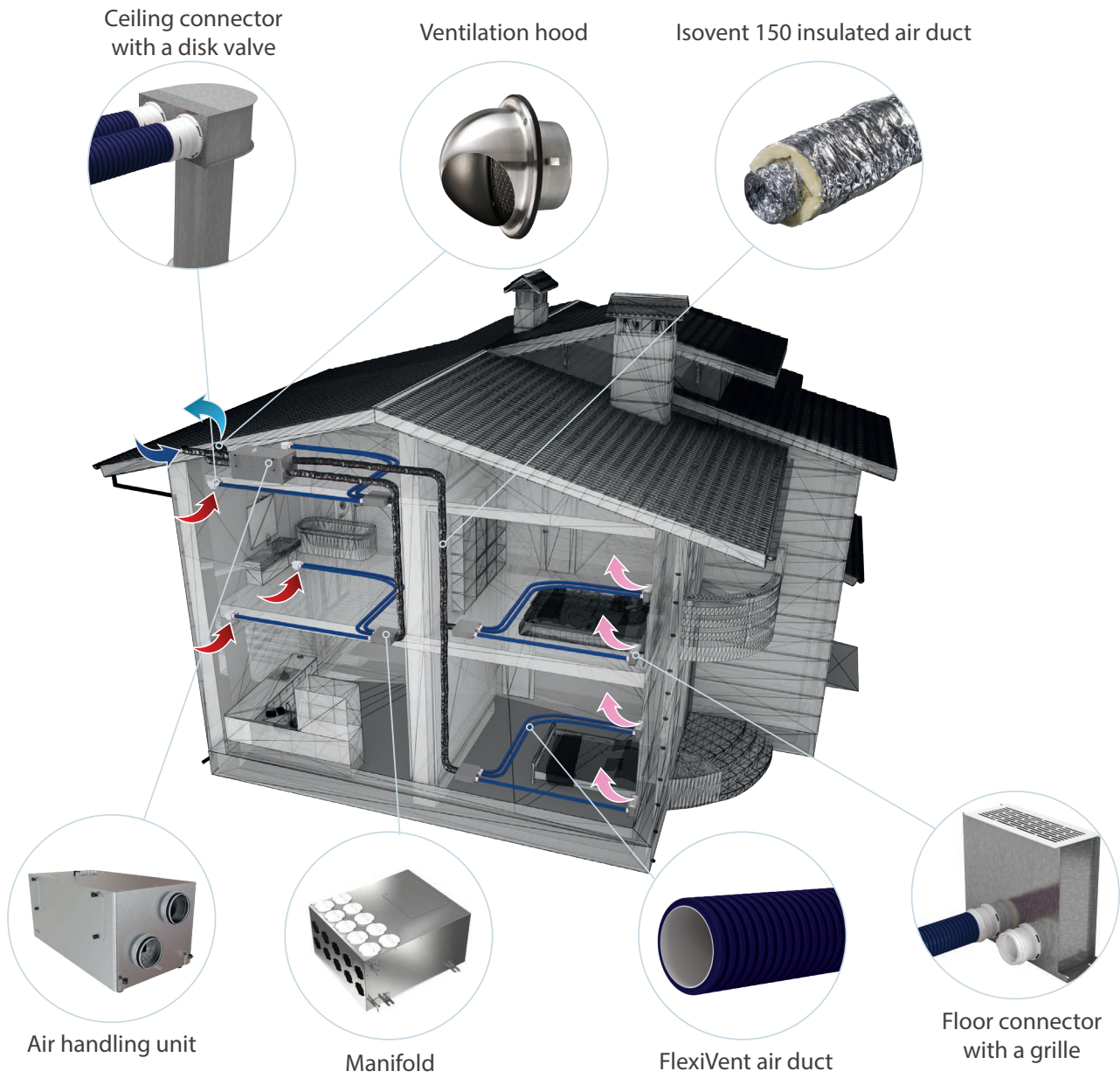

Series
VENTS VUT/VUE PBE EC
VENTS VUT/VUE PBW EC



Ceiling mounted air handling units in compact heat- and sound-insulated casing with an electric heater.
 Air flow up to **4300 m³/h**, heat recovery efficiency up to **90 %**.

■ **Description**

The VUT/VUE PBE EC air handling unit with an electric heater and the VUT/VUE PBW EC air handling unit with a water heater are the fully-featured ventilation units ensuring air filtration, fresh air supply and stale air extraction. The units are suitable for integration into various ventilation and air conditioning networks requiring cost-effective solutions and controllable ventilation.

■ **Modifications**

- VUT PBE EC** – models with an electric heater and a polystyrene or aluminium heat exchanger.
- VUE PBE EC** – models with an electric heater and an enthalpy heat exchanger.
- VUT PBW EC** – models with a water heater and a polystyrene or aluminium heat exchanger.
- VUE PBW EC** – models with a water heater and an enthalpy heat exchanger.

■ **Casing**

The heat- and sound-insulated aluzinc casing is internally filled with mineral wool.

■ **Filter**

To filter the supply and extract air, the unit has two built-in G4 filters. For the VUT/VUE 300/550/900 PBE/PBW EC models, a supply filter with an F7 degree of filtration can be installed as an option.

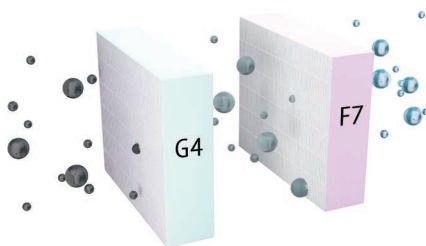

■ **Motor**

High-efficient electronically-commutated motors with external motor and impellers with backward curved blades.

■ **Heat exchanger**

A plate counter-flow polystyrene heat exchanger which returns heat is used in the VUT 300/550/900 PBE/PBW EC units.



The VUT 2000/3000 PBE/PBW EC units are equipped with a cross-flow plate heat exchanger made of aluminium.

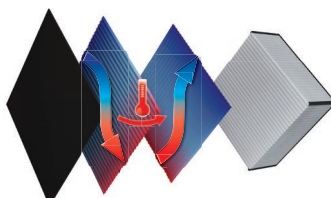

The VUE 300/550/900 PBE/PBW EC units are equipped with enthalpy counter-flow heat exchanger.

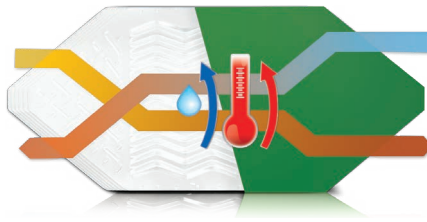

■ **Bypass**

The units are equipped with a bypass for summer cooling.

■ **Heater**

The electric heater (for the VUT/VUE PBE EC unit) or the water heater (for the VUT/VUE PBW EC unit), installed downstream of the heat exchanger. The water heaters are designed for max. operating pressure of 1.0 MPa (10 bar) and max. heat carrier operating temperature of +95 °C.

■ **Control and automation**

The units are equipped with an integrated automation system. The A21 controller enables integration of the unit into the **Smart Home System** or **BMS (Building Management Systems)**. To control the unit via Wi-Fi, download the VENTS Home mobile app.

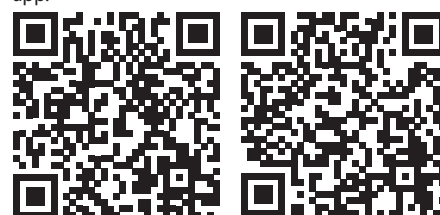

Google play

Download on the App Store





■ **Mounting**

The unit is designed for indoor mounting. While mounting the unit ensure its correct position to enable condensate collection and drainage.

Designation key

Series	Rated air flow [m ³ /h]	Mounting modification	Bypass	Heater type	Motor type	Service side	Control	Accessories
VUT: ventilation with heat recovery VUE: ventilation with energy recovery	300; 550; 900; 2000; 3000	P: suspended	B: Bypass	E: electric W: water	EC: synchronous electronically commutated motor	L: left R: right	A21	DTV: equipped with a differential pressure switch for controlling the contamination of filters

Control and automation

Functions	A21
Wi-Fi control via mobile application	+
Control via wired remote control panel	option (A22) 
Control via wired remote LCD control panel	option (A25) 
Control via wireless remote control panel	option (A22 Wi-Fi) 
BMS	RS-485 Wi-Fi Ethernet MODBUS (RTU, TCP)
Service Vents Cloud Server	+
Speed selection	+
Filter replacement indication	according to a filter timer according to a pressure switch of filter clogging for the units with DTV
Alarm indication	full alarm description in the mobile application
Week-scheduled operation	+
Bypass	auto
	manual
Timer	+
Boost mode	+
Fireplace mode	+
Freeze protection	cyclic shutdown of the supply fan
	through preheating (option) using a bypass
Cooler connection	option
Reheater connection	option
Control of minimum supply air temperature	+
Humidity control	option
CO ₂ control	option
VOC control	option
PM2.5 control	option
Fire alarm sensor	option

*Option. The functionality is available when you purchase the appropriate accessory.

Unit overall dimensions

Type	Dimensions [mm]					
	∅D	B	B1	H	L	L1
VUT/VUE 300 PBE EC	160	485	577	280	1238	1291
VUT/VUE 550 PBE/PBW EC	200	827	960	280	1238	1291
VUT/VUE 900 PBE/PBW EC	250	1351	1485	318	1349	1402
VUT 2000 PBE/PBW EC	315	950	-	762	1400	1452
VUT 3000 PBE/PBW EC	400	1265	-	881	1835	1888

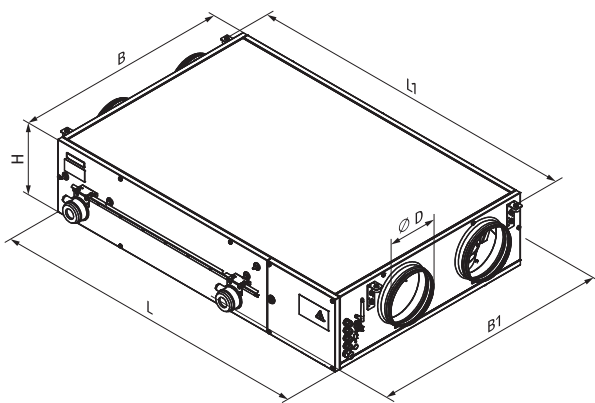

VUT/VUE 550 PBE EC
VUT/VUE 550 PBW EC

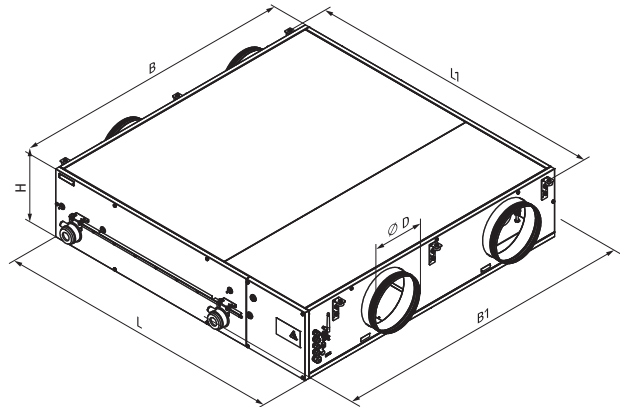

VUT/VUE 900 PBE EC
VUT/VUE 900 PBW EC

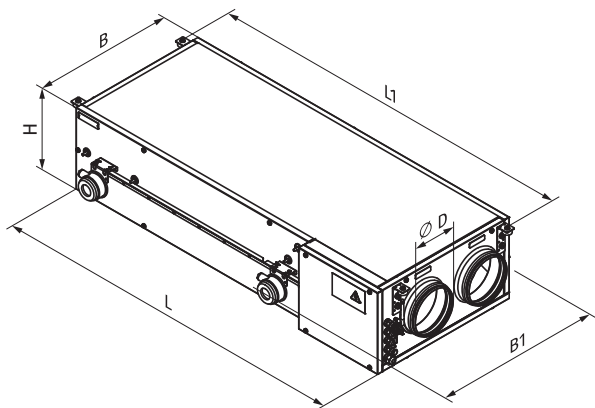

VUT/VUE 300 PBE EC

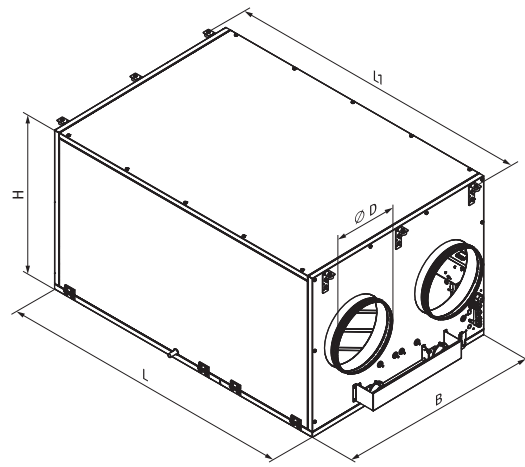

VUT 2000(3000) PBE EC
VUT 2000(3000) PBW EC

Technical data

	VUT 300 PBE EC	VUE 300 PBE EC	VUT 550 PBE EC	VUE 550 PBE EC	VUT 550 PBW EC	VUE 550 PBW EC
Voltage [V/50-60 Hz]	1~230		1~230		1~230	
Max. unit power without electric heater [W]	180		297		297	
Integrated electric heater power [W]	1500		2000		-	
Max. unit power with electric heater [W]	1 680		2 297		297	
Max. unit current without electric heater [A]	1.4		2.4		2.4	
Integrated electric heater current [A]	6.5		8.7		-	
Max. unit current with electric heater [A]	7.9		11.1		2.4	
Number of water (glycol) coil rows	-		-		2	
Max. air flow [m ³ /h]	340		620		620	
RPM [min ⁻¹]	3270		3100		3100	
Sound pressure level at 3 m distance [dBA]	27		30		30	
Max. transported air temperature [°C]			-25...+40			
Casing material	aluzinc					
Insulation	20 mm, mineral wool					
Extract filter	G4					
Supply filter	G4 (F7 option)					
Connected air duct diameter [mm]	160		200		200	
Weight [kg]	44		67		68	
Heat recovery efficiency [%]	72-90	69-87	78-90	69-87	78-90	69-87
Heat exchanger type	counter-flow					
Heat exchanger material	polystyrene	enthalpy	polystyrene	enthalpy	polystyrene	enthalpy
SEC class	A		A		A	

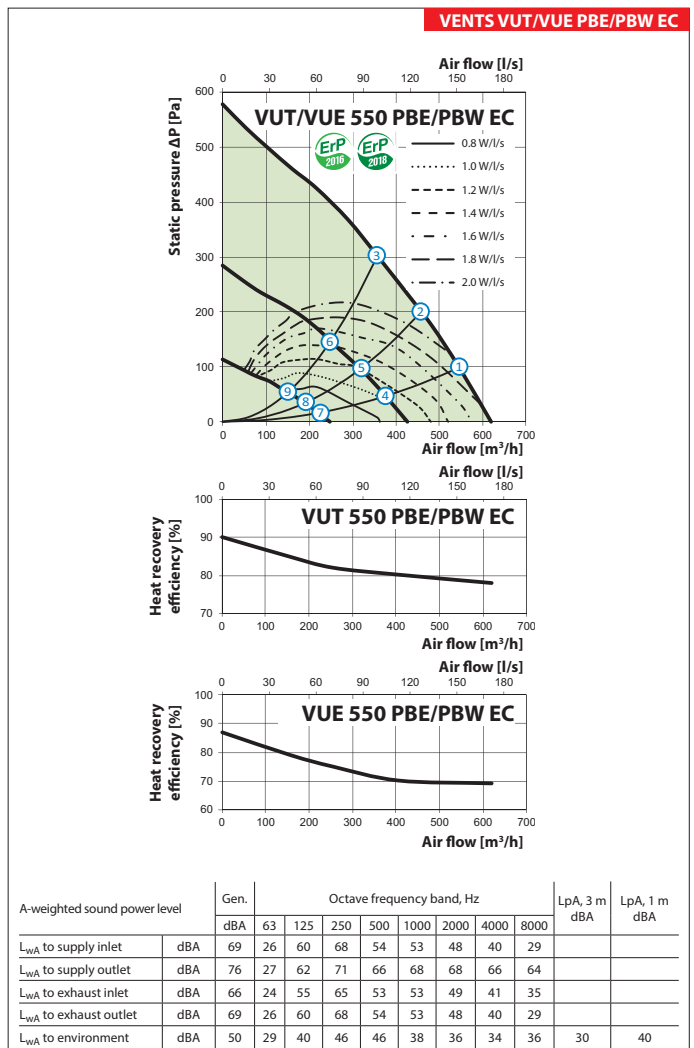
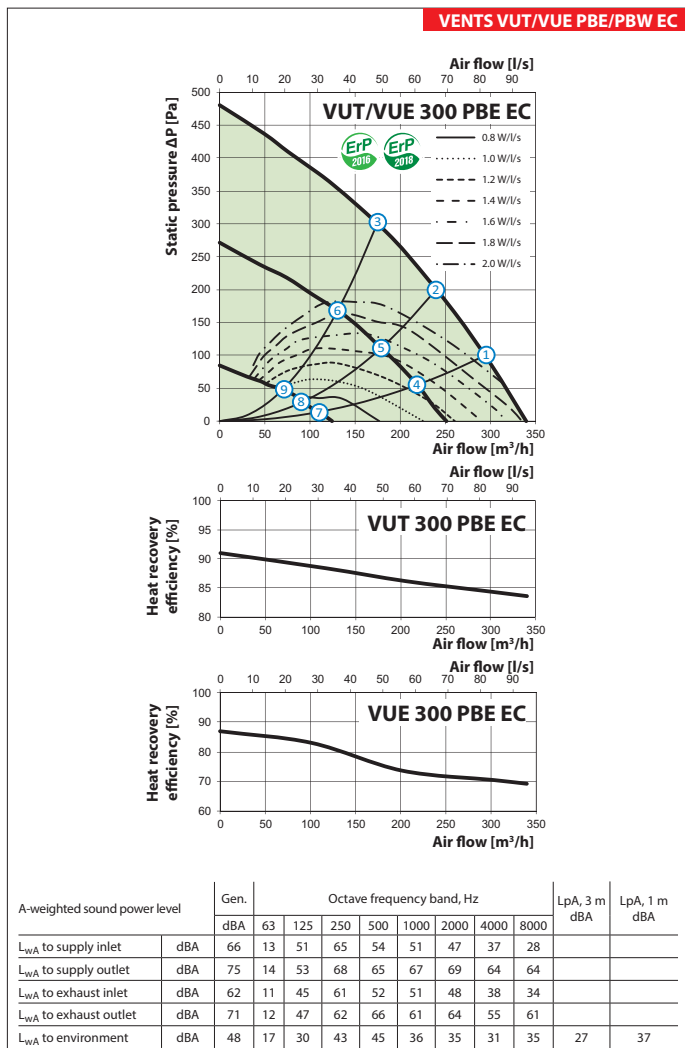

AIR HANDLING UNITS WITH HEAT RECOVERY

Technical data

	VUT 900 PBE EC	VUE 900 PBE EC	VUT 900 PBW EC	VUE 900 PBW EC
Voltage [V/50-60 Hz]	1~230		1~230	
Max. unit power without electric heater [W]	442		442	
Integrated electric heater power [W]	3300		-	
Max. unit power with electric heater [W]	3742		442	
Max. unit current without electric heater [A]	3.1		3	
Integrated electric heater current [A]	14.3		-	
Max. unit current with electric heater [A]	17.4		3	
Number of water (glycol) coil rows	-		2	
Max. air flow [m ³ /h]	1030		1030	
RPM [min ⁻¹]	2720		2720	
Sound pressure level at 3 m distance [dBA]	33		33	
Max. transported air temperature [°C]	-25...+40		-25...+40	
Casing material	aluzinc			
Insulation	20 mm, mineral wool			
Extract filter	G4			
Supply filter	G4 (F7 option)			
Connected air duct diameter [mm]	250		250	
Weight [kg]	111		112	
Heat recovery efficiency [%]	75-88	69-85	75-88	69-85
Heat exchanger type	counter-flow			
Heat exchanger material	polystyrene	enthalpy	polystyrene	enthalpy
SEC class	A	A	A	A

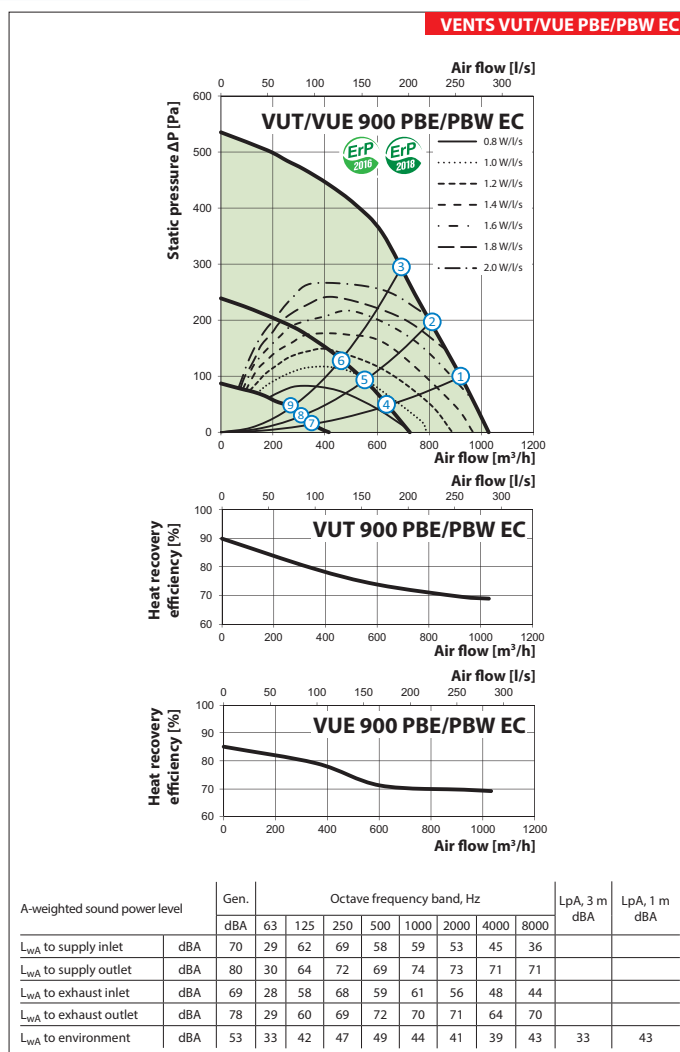

Technical data

	VUT 2000 PBE EC	VUT 2000 PBW EC	VUT 3000 PBE EC	VUT 3000 PBW EC
Voltage [V/50-60 Hz]	3~400	1~230	3~400	
Max. unit power without electric heater [W]		876		2226
Integrated electric heater power [W]	15000	-	21000	-
Max. unit power with electric heater [W]	15876	876	23226	2 226
Max. unit current without electric heater [A]		5.3		3.5
Integrated electric heater current [A]	21.7	-	30	-
Max. unit current with electric heater [A]	27.0	5.3	33.5	3.5
Number of water (glycol) coil rows	-	2	-	2
Max. air flow [m ³ /h]		2100		4300
RPM [min ⁻¹]		2920		3400
Sound pressure level at 3 m distance [dBA]		36		46
Max. transported air temperature [°C]		-25...+40		-25+40
Casing material	aluzinc			
Insulation	20 mm, mineral wool			
Extract filter	G4			
Supply filter	G4			
Connected air duct diameter [mm]	315		400	
Weight [kg]	140		281	268
Heat recovery efficiency [%]	50-67		59-72	
Heat exchanger type	cross-flow type			
Heat exchanger material	aluminum			
SEC class	NRVU			

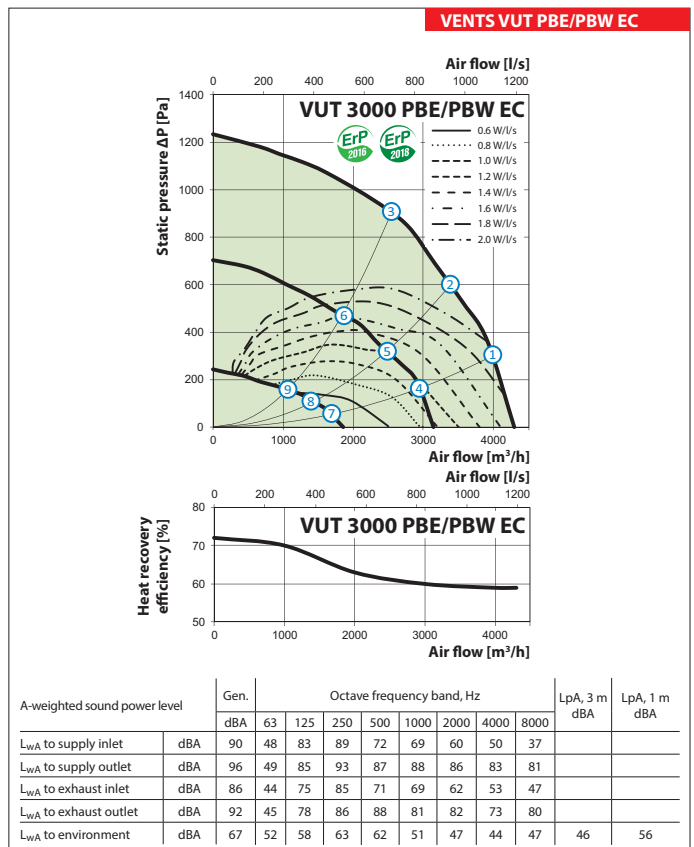
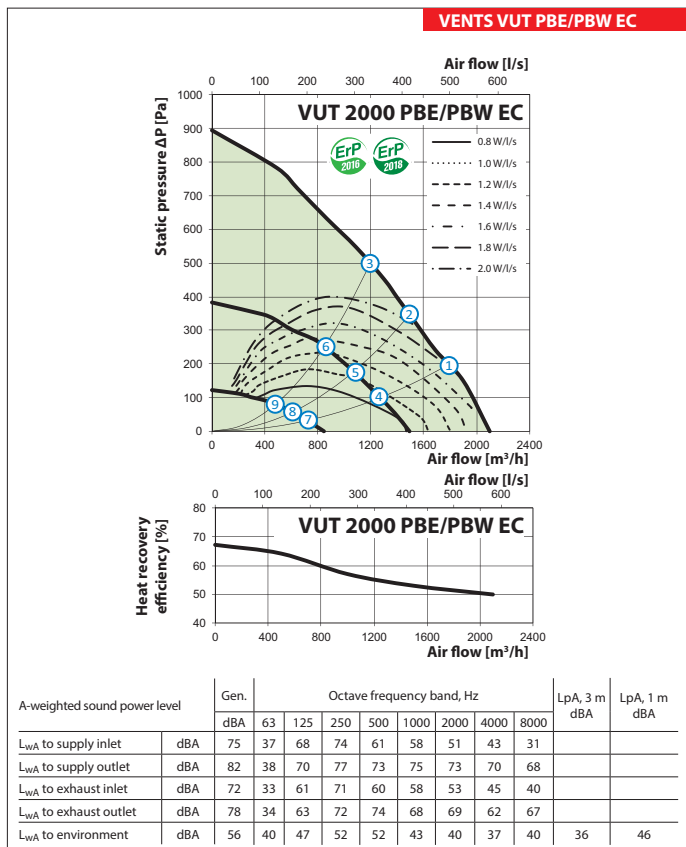

AIR HANDLING UNITS WITH HEAT RECOVERY

Point	Unit power [W]				
	VUT/VUE 300 PBE EC	VUT/VUE 550 PBE/PBW EC	VUT 900 PBE/PBW EC	VUT 2000 PBE/PBW EC	VUT 3000 PBE/PBW EC
1	174	294	442	875	2200
2	168	285	442	866	2220
3	152	271	442	836	2143
4	77	109	160	320	858
5	74	106	149	318	868
6	68	101	147	301	840
7	19	34	46	84	198
8	19	34	43	84	200
9	18	32	40	74	162

Accessories for air handling units

Model	G4 pocket filter	F7 pocket filter	G4 panel filter	Control panel	Wi-Fi control-lable control panel	LCD control panel	Humidity sensor (0-10 V)	CO ₂ sensor	CO ₂ sensor with indication	Humidity sensor	VOC sensor (0-10 V)	CO ₂ sensor (0-10 V)	Humidity sensor (0-10 V)
VUT 300 PBE EC A21	SFK 208x236x27 G4	SFK 208x236x27 F7	SF 440x128x20 G4										
VUT 550 PBE EC A21	SFK 392x236x27 G4	SFK 392x236x27 F7	SF 782x128x20 G4										
VUT 900 PBE EC A21	SFK 647x274x27 G4	SFK 647x274x27 F7	SF 647x274x20 G4										
VUE 300 PBE EC A21	SFK 208x236x27 G4	SFK 208x236x27 F7	SF 440x128x20 G4										
VUE 550 PBE EC A21	SFK 392x236x27 G4	SFK 392x236x27 F7	SF 782x128x20 G4										
VUE 900 PBE EC A21	SFK 647x274x27 G4	SFK 647x274x27 F7	SF 647x274x20 G4										
VUT 2000 PBE EC A21	-	-	SF 708x480x48 G4	A22	A22 WiFi	A25	HV2	CO2-1	CO2-2	HR-S	DPWQ 30600	DPWQ 40200	DPWC 11200
VUT 3000 PBE EC A21	-	-	SF 827x741x48 G4										
VUT 550 PBW EC A21	SFK 392x236x27 G4	SFK 392x236x27 F7	SF 782x128x20 G4										
VUT 900 PBW EC A21	SFK 647x274x27 G4	SFK 647x274x27 F7	SF 647x274x20 G4										
VUE 550 PBW EC A21	SFK 392x236x27 G4	SFK 392x236x27 F7	SF 782x128x20 G4										
VUE 900 PBW EC A21	SFK 647x274x27 G4	SFK 647x274x27 F7	SF 647x274x20 G4										
VUT 2000 PBW EC A21	-	-	SF 708x480x48 G4										
VUT 3000 PBW EC A21	-	-	SF 827x741x48 G4										

Model	Kitchen hood	Hydraulic U-trap	Silencer		Backdraft damper	Air damper	Clamps	Electric actuators		Mixing unit
VUT 300 PBE EC A21			SR 160 600/900/1200	SRF 160 600/900/1200	KOM 160	KRV 160	C 160			
VUT 550 PBE EC A21		SH-32	SR 200 600/900/1200	SRF 200 600/900/1200	KOM 200	KRV 200	C 200			
VUT 900 PBE EC A21			SR 250 600/900/1200	SRF 250 600/900/1200	KOM 250	KRV 250	C 250			
VUE 300 PBE EC A21			SR 160 600/900/1200	SRF 160 600/900/1200	KOM 160	KRV 160	C 160			
VUE 550 PBE EC A21		-	SR 200 600/900/1200	SRF 200 600/900/1200	KOM 200	KRV 200	C 200			
VUE 900 PBE EC A21			SR 250 600/900/1200	SRF 250 600/900/1200	KOM 250	KRV 250	C 250			
VUT 2000 PBE EC A21			SR 315 600/900/1200	SRF 315 600/900/1200	KOM 315	KRV 315	C 315			
VUT 3000 PBE EC A21		KH-1	SR 400 600/900/1200	-	KOM 400	KRV 400	C 400	LF230	TF230	
VUT 550 PBW EC A21		SH-32	SR 200 600/900/1200	SRF 200 600/900/1200	KOM 200	KRV 200	C 200			
VUT 900 PBW EC A21			SR 250 600/900/1200	SRF 250 600/900/1200	KOM 250	KRV 250	C 250			
VUE 550 PBW EC A21			SR 200 600/900/1200	SRF 200 600/900/1200	KOM 200	KRV 200	C 200			
VUE 900 PBW EC A21		-	SR 250 600/900/1200	SRF 250 600/900/1200	KOM 250	KRV 250	C 250			USWK
VUT 2000 PBW EC A21			SR 315 600/900/1200	SRF 315 600/900/1200	KOM 315	KRV 315	C 315			
VUT 3000 PBW EC A21		SH-32	SR 400 600/900/1200	-	KOM 400	KRV 400	C 400			

Water heater parameters calculation

VUT PBW EC

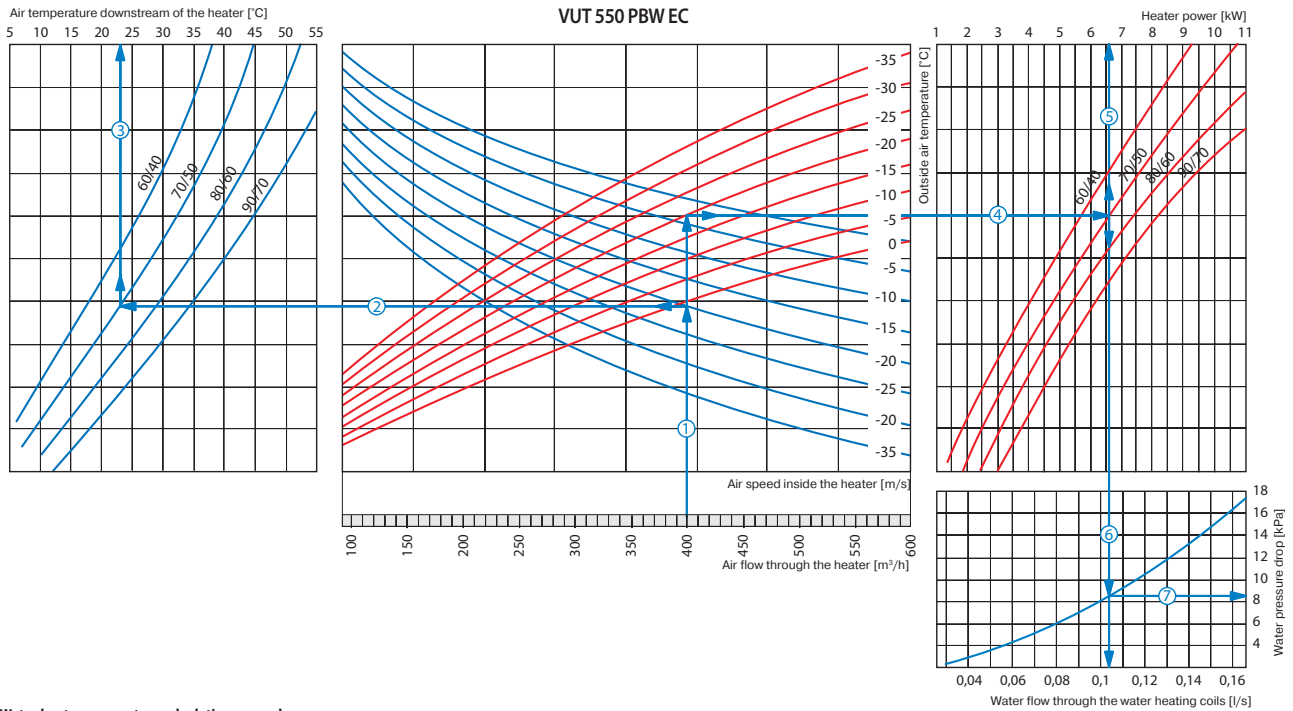

Water heater parameters calculation example

- To calculate the maximum air temperature, find the intersection point of the air flow line ① with the rated winter temperature shown in blue line (e.g., 400 m³/h) and draw the line ② to the left until it crosses the water in/out temperature curve (e.g. +70/+50). From this point draw a vertical line to the supply air temperature downstream of the heater (+23 °C) ③.
- To calculate the heater power, find the intersection point of the air flow ① with the rated winter temperature shown in red line (e.g., -20 °C) and draw the line ④ to the right until it crosses the water in/out temperature curve (e.g. +70/+50). From this point draw a vertical line to the heater power axis (6.6 kW) ⑤.
- To calculate the required water flow in the heater, prolong this line ⑥ downwards to the water flow axis (0,105 l/s).
- To calculate the water pressure drop in the heater, find the intersection point of the line ⑥ with the pressure loss curve and prolong the line ⑦ to the right on the water pressure drop axis (8.5 kPa).

VUT PBW EC

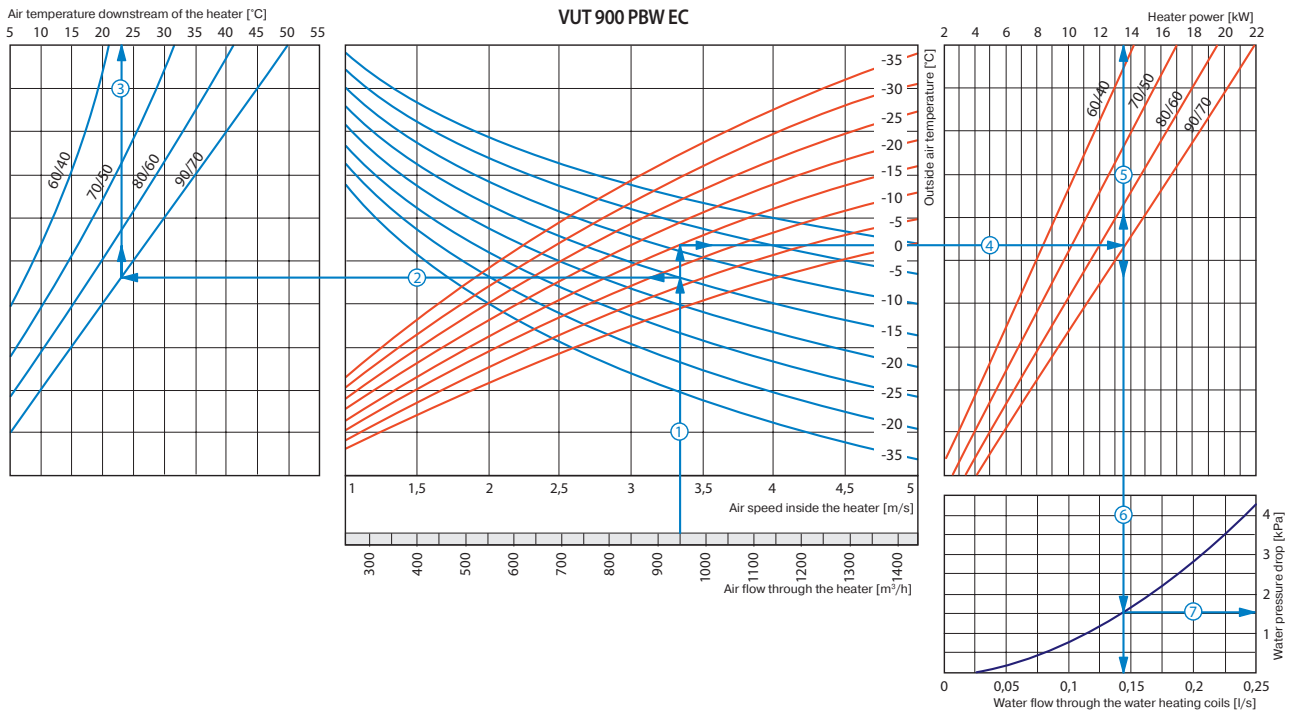

Water heater parameters calculation example

The air flow is 950 m³/h and the air speed in the heater is 3.35 m/s ①.

- To calculate the maximum air temperature, find the intersection point of the air flow line ① with the rated winter temperature shown in blue line (e.g., -15 °C) and draw the line ② to the left until it crosses the water in/out temperature curve (e.g. +90/+70). From this point draw a vertical line to the supply air temperature downstream of the heater (+23 °C) ③.
- To calculate the heater power, find the intersection point of the air flow ① with the rated winter temperature shown in red line (e.g., -20 °C) and draw the line ④ to the right until it crosses the water in/out temperature curve (e.g. +90/+70). From this point draw a vertical line to the heater power axis (13.5 kW) ⑤.
- To calculate the required water flow in the heater, prolong this line ⑥ downwards to the water flow axis (0,14 l/s).
- To calculate the water pressure drop in the heater, find the intersection point of the line ⑥ with the pressure loss curve and prolong the line ⑦ to the right on the water pressure drop axis (1.5 kPa).

Water heater parameters calculation

VUT PBW EC

Air temperature downstream of the heater [°C]
5 20 25 30 35 40 45 50 55 60 65

VUT 2000 PBW EC

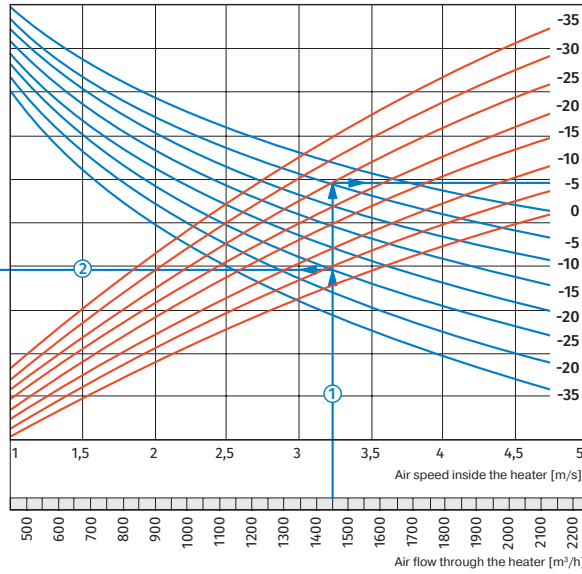
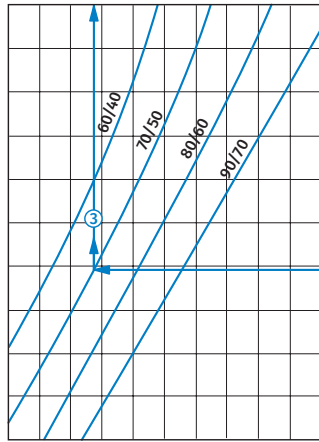

Heater power [kW]
10 15 20 25 30 32 40 45 50

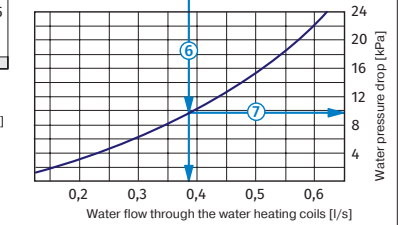
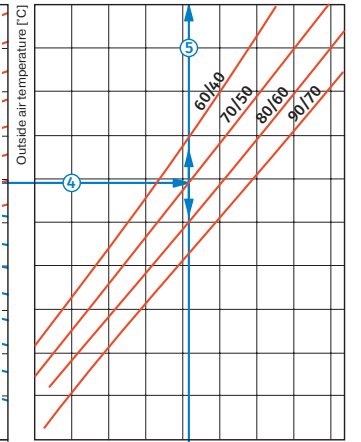

Water heater parameters calculation example

The air flow is 1450 m³/h and the air speed in the heater is 3.2 m/s ①.

- To calculate the maximum air temperature, find the intersection point of the air flow line ① with the rated winter temperature shown in blue line (e.g., -25 °C) and draw the line ② to the left until it crosses the water in/out temperature curve (e.g. +70/+50). From this point draw a vertical line to the supply air temperature downstream of the heater (+28 °C) ③.
- To calculate the heater power, find the intersection point of the air flow ① with the rated winter temperature shown in red line (e.g., -25 °C) and draw the line ④ to the right until it crosses the water in/out temperature curve (e.g. +70/+50). From this point draw a vertical line to the heater power axis (31 kW) ⑤.
- To calculate the required water flow in the heater, prolong this line ⑥ downwards to the water flow axis (0,38 l/s).
- To calculate the water pressure drop in the heater, find the intersection point of the line ⑥ with the pressure loss curve and prolong the line ⑦ to the right on the water pressure drop axis (9,8 kPa).

VUT PBW EC

Air temperature downstream of the heater [°C]
5 10 15 20 25 30 35 40 45 50 55

VUT 3000 PBW EC

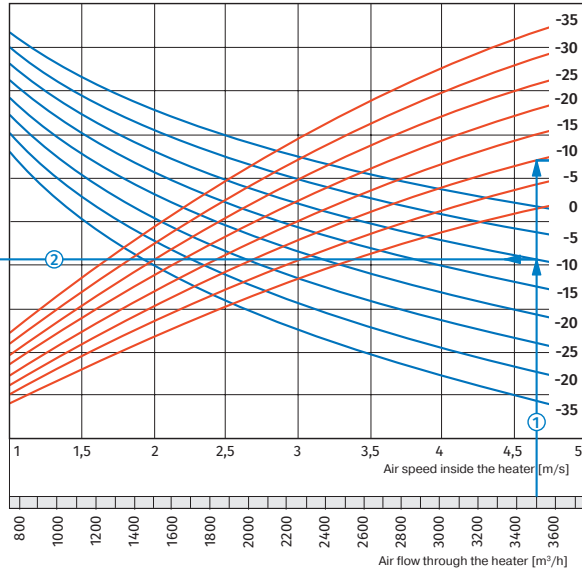
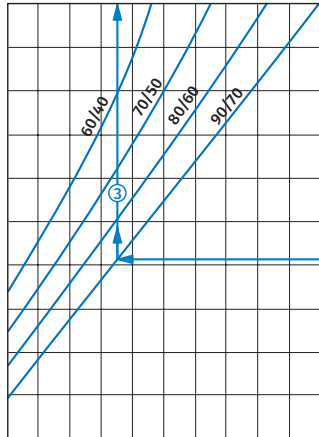

Heater power [kW]
10 20 30 40 50 60

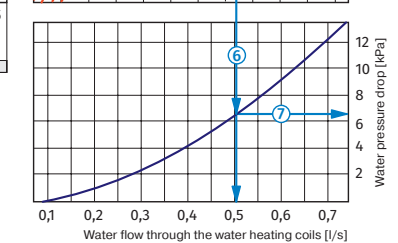
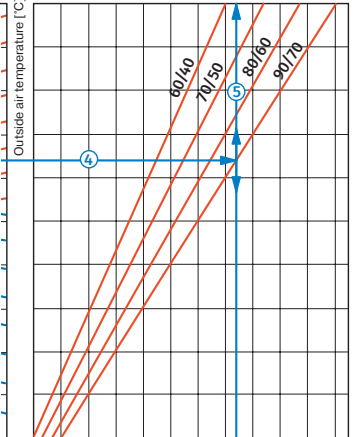

Water heater parameters calculation example

The air flow is 3500 m³/h and the air speed in the heater is 4.65 m/s ①.

- To calculate the maximum air temperature, find the intersection point of the air flow line ① with the rated winter temperature shown in blue line (e.g., -10 °C) and draw the line ② to the left until it crosses the water in/out temperature curve (e.g. +90/+70). From this point draw a vertical line to the supply air temperature downstream of the heater (+22,5 °C) ③.
- To calculate the heater power, find the intersection point of the air flow ① with the rated winter temperature shown in red line (e.g., -10 °C) and draw the line ④ to the right until it crosses the water in/out temperature curve (e.g. +90/+70). From this point draw a vertical line to the heater power axis (42 kW) ⑤.
- To calculate the required water flow in the heater, prolong this line ⑥ downwards to the water flow axis (0,5 l/s).
- To calculate the water pressure drop in the heater, find the intersection point of the line ⑥ with the pressure loss curve and prolong the line ⑦ to the right on the water pressure drop axis (6,5 kPa).

Series
VENTS VUT H



Speed controller A6

Air handling units with the air flow up to **2200 m³/h** and the heat recovery efficiency up to 88 % in the compact sound- and heat-insulated casing

■ **Description**

Air handling unit VUT H is a complete ventilation units designed for air filtration and supply to the premises and exhaust air removal.

■ **Casing**

The casing is made of aluminium profile, double skinned with 20 mm mineral wool heat-and sound-insulating layer.

■ **Filter**

Two G4 panel filters for extract air ventilation are supplied with the unit.

■ **Fans**

The unit is equipped with supply and exhaust centrifugal double-inlet fans with forward curved blades and built-in thermal overheating protection with automatic restart.

■ **Heat exchanger**

The cross-flow heat exchanger is made of polystyrene. Whenever heat recovery is not required the heat

exchanger block can be easily replaced by a «summer» block. The unit is also equipped with the drain pan for condensate water drainage as well as built-in freezing protection system.

■ **Control**

The motor speed is controlled with 4-step control switch.

■ **Mounting**

Air handling unit is mounted on the floor and suspended to the ceiling by means of a seat angle with anti-vibration mounts or attached to a wall with brackets.

Unit overall dimensions

Type	Dimensions [mm]									
	∅D	B	B1	B2	B3	H	H1	H2	L	L1
VUT 350 H	124	416	300	54	207	603	230	148	722	768
VUT 500 H	149	416	300	54	207	603	230	148	722	768
VUT 530 H	159	416	300	54	207	603	230	148	722	768
VUT 600 H	199	416	300	54	207	603	230	148	722	768
VUT 1000 H	248	548	496	60	213	794	290	200	802	850
VUT 2000 H	313	846	796	235	588	968	360	246	1000	1050

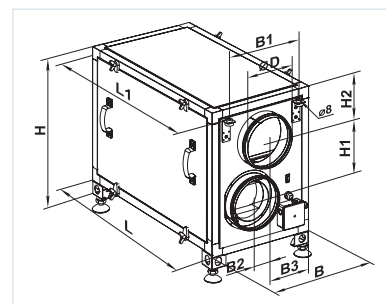

Accessories to air handling units

Model	G4 panel filter	Silencers		Back valves	Air dampers	Clamps	Summer blocks
VUT 350 H	SF 378x210x48 G4	SR 125 600/900/1200	SRF 125 600/900/1200	KOM 125	KR 125	C 125	VL C4 200/384
VUT 500 H		SR 150 600/900/1200	SRF 150 600/900/1200	KOM 150	KR 150	C 150	VL C4 300/384
VUT 530 H		SR 160 600/900/1200	SRF 160 600/900/1200	KOM 160	KR 160	C 160	VL C4 300/384
VUT 600 H	SF 450x295x48 G4	SR 200 600/900/1200	SRF 200 600/900/1200	KOM 200	KR 200	C 200	VL C4 300/384
VUT 1000 H		SR 250 600/900/1200	SRF 250 600/900/1200	KOM 250	KR 250	C 250	VL C4 300/450
VUT 2000 H		SR 315 600/900/1200	SRF 315 600/900/1200	KOM 315	KR 315	C 315	VL C4 300/750

Designation key

Series	Rated air flow, m ³ /h	Duct connection
VENTS VUT	350; 500; 530; 600; 1000; 2000	H: horizontal

VUT H unit air exchange example in the flat

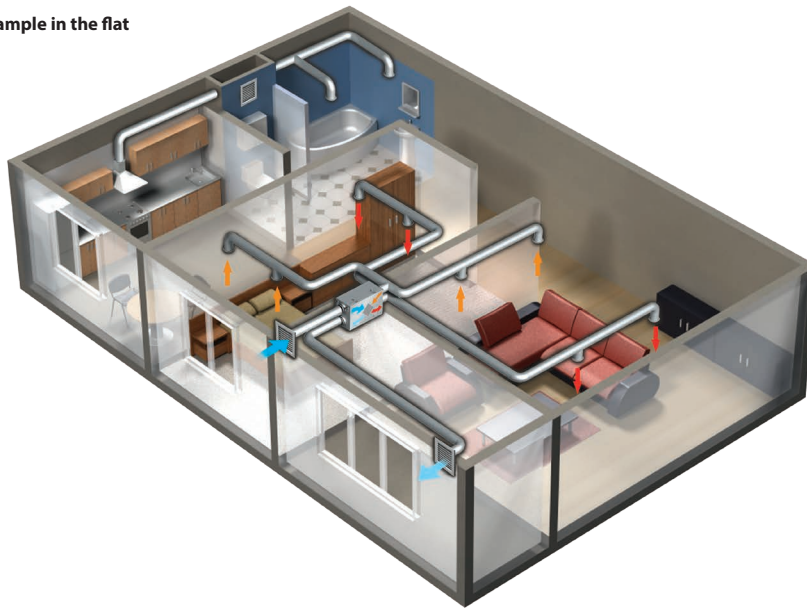

Technical data

	VUT 350 H	VUT 500 H	VUT 530 H
Voltage [V/Hz]	1~230/50-60	1~230/50-60	1~230/50-60
Total unit power [W]	260	300	300
Total unit current [A]	1.2	1.32	1.32
Air flow [m³/h]	350	500	530
RPM	1150	1100	1100
Noise level at 3m [dBA]	24-45	28-47	28-47
Transported air [°C]	-25...+40	-25...+40	-25...+40
Casing material	aluzinc	aluzinc	aluzinc
Insulation	25 mm mineral wool	25 mm mineral wool	25 mm mineral wool
Extract filter	G4	G4	G4
Supply filter	G4	G4	G4
Connected air duct diameter [mm]	∅ 125	∅ 150	∅ 160
Weight [kg]	45	49	49
Heat recovery efficiency	up to 78 %	up to 88 %	up to 88 %
Heat exchanger type	cross-flow type	cross-flow type	cross-flow type
Heat exchanger material	polystyrol	polystyrol	polystyrol

Technical data

	VUT 600 H	VUT 1000 H	VUT 2000 H
Voltage [V/Hz]	1~230/50-60	1~230/50-60	1~230/50-60
Total unit power [W]	390	820	1300
Total unit current [A]	1.72	3.6	5.68
Air flow [m³/h]	600	1200	2200
RPM	1350	1850	1150
Noise level at 3m [dBA]	32-48	60	65
Transported air [°C]	-25...+40	-25...+40	-25...+40
Casing material	aluzinc	aluzinc	aluzinc
Insulation	25 mm mineral wool	50 mm mineral wool	50 mm mineral wool
Extract filter	G4	G4	G4
Supply filter	G4	G4	G4
Connected air duct diameter [mm]	∅ 200	∅ 250	∅ 315
Weight [kg]	54	85	96
Heat recovery efficiency	up to 85 %	up to 88 %	up to 87 %
Heat exchanger type	cross-flow type	cross-flow type	cross-flow type
Heat exchanger material	polystyrol	polystyrol	polystyrol

VENTS VUT H

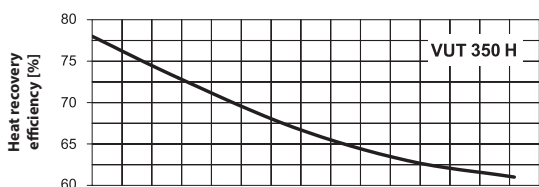
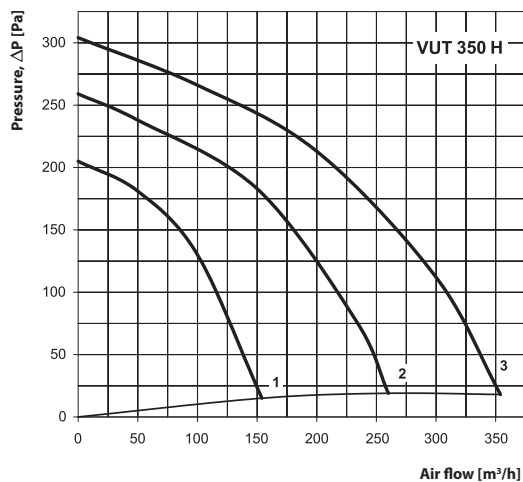

Sound-power level	Hz	Octave-frequency band [Hz]								
		Gen	63	125	250	500	1000	2000	4000	8000
L_{WA} to inlet	dBA	52	30	48	47	37	43	40	32	20
L_{WA} to outlet	dBA	61	39	56	58	53	48	47	37	23
L_{WA} to environment	dBA	31	22	23	30	27	21	16	20	22

VENTS VUT H

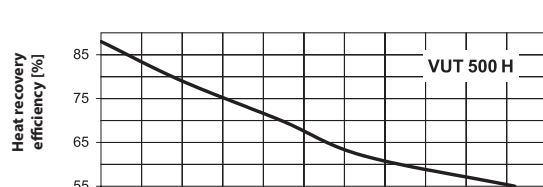
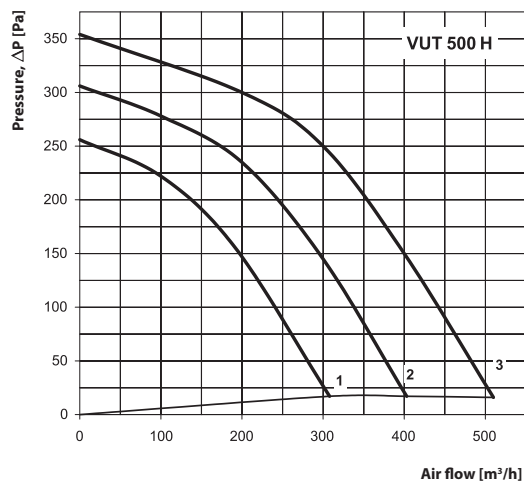

Sound-power level	Hz	Octave-frequency band [Hz]								
		Gen	63	125	250	500	1000	2000	4000	8000
L_{WA} to inlet	dBA	54	33	49	51	40	45	43	34	22
L_{WA} to outlet	dBA	65	41	58	59	55	48	48	39	27
L_{WA} to environment	dBA	37	25	26	33	29	20	19	22	23

VENTS VUT H

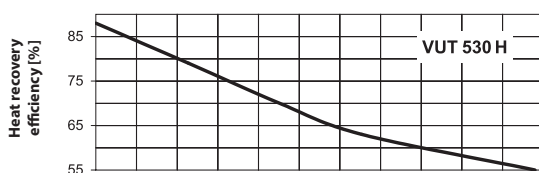
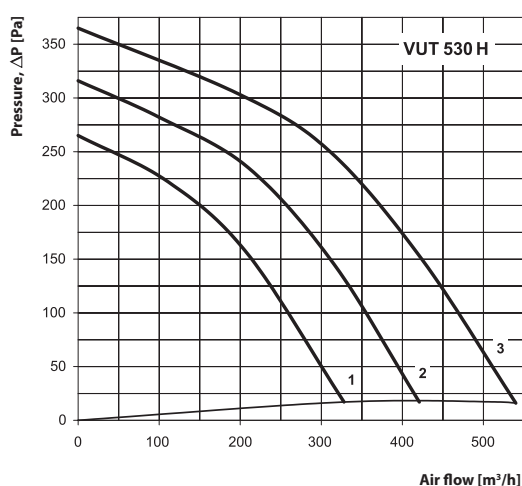

Sound-power level	Hz	Octave-frequency band [Hz]								
		Gen	63	125	250	500	1000	2000	4000	8000
L_{WA} to inlet	dBA	55	33	51	50	39	46	41	34	21
L_{WA} to outlet	dBA	62	43	58	60	57	49	48	38	26
L_{WA} to environment	dBA	36	25	26	33	30	20	18	23	25

VENTS VUT H

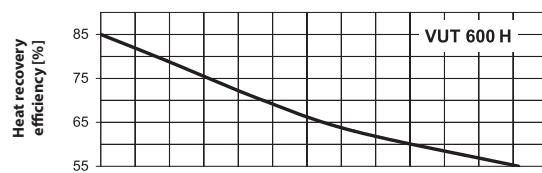
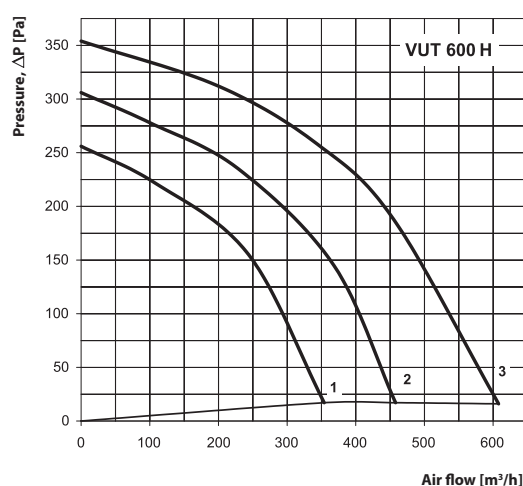

Sound-power level	Hz	Octave-frequency band [Hz]								
		Gen	63	125	250	500	1000	2000	4000	8000
L_{WA} to inlet	dBA	57	36	53	53	41	48	46	38	25
L_{WA} to outlet	dBA	66	44	61	63	59	50	50	39	29
L_{WA} to environment	dBA	40	26	29	37	35	25	23	26	27

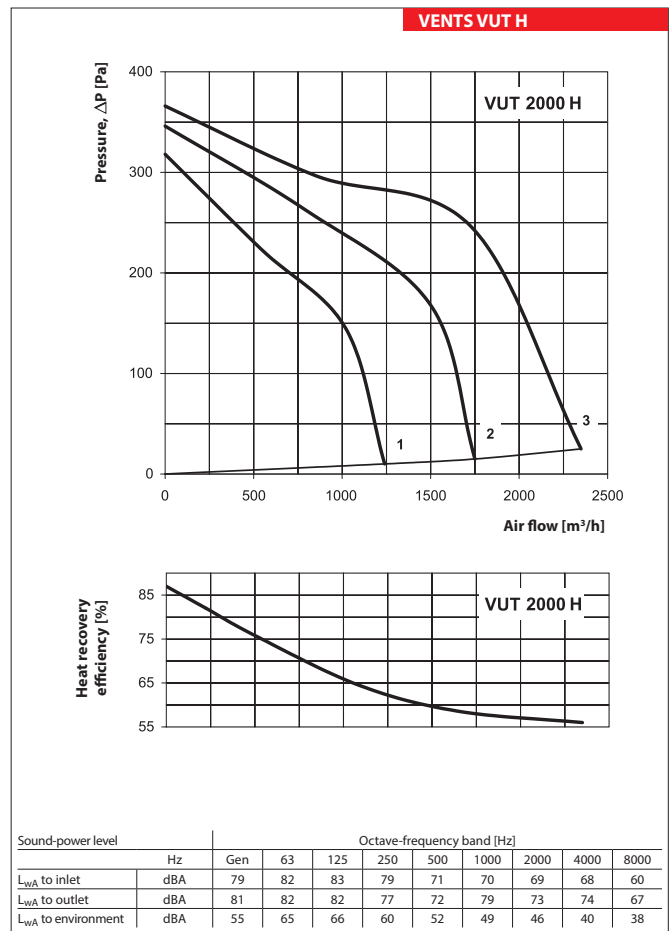
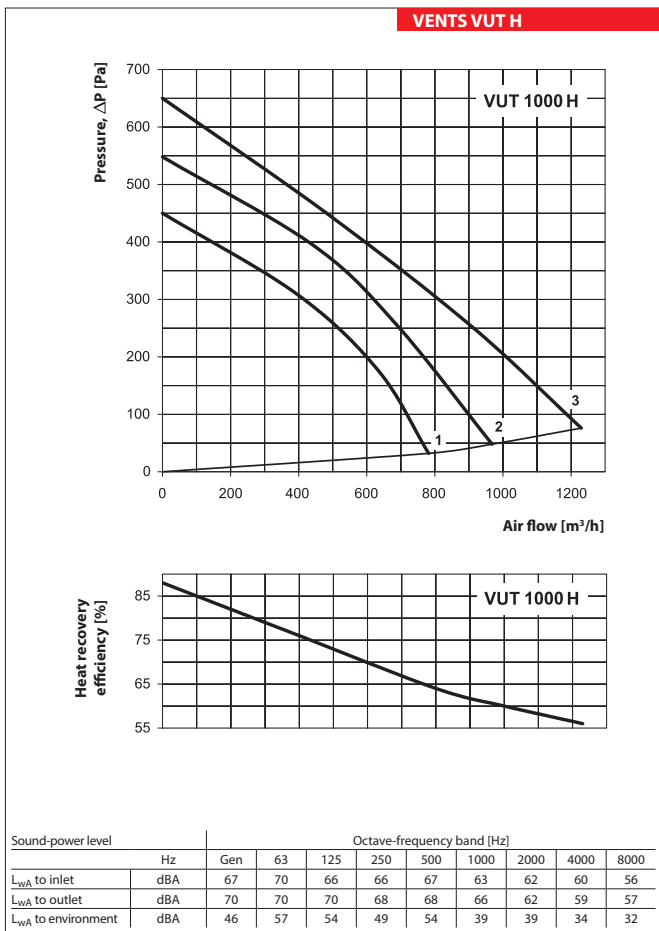

Series
VENTS VUT EH



A16 control panel

Air handling units with the air flow up to **2200 m³/h** and heat recovery efficiency up to 88 % in sound-proof and heat-insulated casing with electric heater

■ **Description**

The VUT EH air handling units with an electric heater and VUT WH units with a water heater are used in ventilation and air conditioning systems in commercial, office and other public or industrial premises that require an economical solution and a controlled ventilation system.

■ **Modifications**

VUT EH – an electric heater and air filters.

VUT WH – a water or glycol heater and air filters.

■ **Casing**

The casing is made of aluzinc steel with 25 mm thick mineral wool heat- and sound-insulating layer.

■ **Filter**

Two G4 panel filters for extract air ventilation are supplied with the unit.

■ **Fans**

The units are equipped with supply and exhaust centrifugal double-inlet fans with forward curved blades and built-in thermostat with automatic restart.

■ **Heat exchanger**

The heat exchangers have high efficiency and are made of polystyrene. The unit is also equipped with the drain pan for condensate drainage.

Series
VENTS VUT WH



A13 control panel

Air handling units with the air flow up to **2100 m³/h** and heat recovery efficiency up to 78 % in sound-proof and heat-insulated casing with water heater

■ **Heater**

The electric heater (for the unit VUT EH) or the water heater (for the unit VUT WH). The water heaters are designed for max. operating pressure 1.0 MPa (10 bar) and max. heat medium operating temperature 95 °C.

■ **Automation and control system**

The unit incorporates an integrated automation and control system with a multi-functional control panel with LCD display. The standard delivery set includes 10 m connection cable for connection to the remote control panel.

■ **VUT EH control and protection functions**

- ▶ control from the control panel: switching on/off, speed selection, timer, faults
- ▶ maintaining the set room temperature by the sensor on the control panel – smooth heating capacity control
- ▶ three-speed fan speed control (low-medium-high);
- ▶ unit operation according to daily and week schedule (timer adjustable from the control panel)
- ▶ safe start-up/shutdown of the fans
- ▶ electric heater overheating protection by the temperature sensor installed in the supply air duct and by two overheating thermostats, one thermostat activated at 60 °C with automatic reset and another thermostat activated at 90 °C with manual reset.

Blowing of the heating elements for heat removing at the end of the heating cycle

- ▶ filter clogging control by engine filter time.

■ **VUT WH control and protection functions**

- ▶ control from the control panel: switching on/off, three-speed fan selection, selecting heating/cooling modes (if connected to duct heater); room temperature display;
- ▶ maintaining supply air temperature set from the control panel by controlling the circulation pump and actuating the heat medium regulating valve; input from the heat medium flow switch (pump alarm);
- ▶ Safe start-up/ shutdown of the fans, warming up of the water heater before start-up; return heat medium temperature control when the fan is off.
- ▶ Freezing protection of the water heating coils by the exhaust temperature sensor and the return heat medium temperature sensor.
- ▶ Control of the compressor and condensing unit of the water cooler by the room temperature sensor (for the models equipped with a duct air cooler).
- ▶ Actuating the external air dampers with a return spring.
- ▶ Unit operation according to week schedule (set at the system setup).
- ▶ unit shut down at signal from the fire alarm system;
- ▶ smooth bypass damper control in the bypassing mode to prevent the heat exchanger freezing.

■ **Mounting**

The unit is designed for indoor mounting. While mounting the unit provide the correct condensate collection and drainage. Access for the unit servicing and filter cleaning is from the side panels on the left from supply air side.

Designation key

Series	Rated air flow [m ³ /h]	Heater type	Duct connection	Row number of the heater	Service side (for VUT 1500 WH, VUT 2000 WH)
VENTS VUT	350; 500; 530; 600; 800; 1000; 1500; 2000	E: electric W: water	H: horizontal	2: two rows 4: four rows	L: left side R: right side

Unit overall dimensions

Type	Dimensions [mm]											
	∅D	B	B1	B2	B3	H	H1	H2	H3	L	L1	L2
VUT 350 EH	124	497	403	248	348	554	–	111	230	954	996	1054
VUT 500 EH	149	497	403	248	348	554	–	111	230	954	996	1054
VUT 530 EH	159	497	403	248	348	554	–	111	230	954	996	1054
VUT 600 EH	199	497	403	248	348	554	–	111	230	954	996	1054
VUT 800 EH	249	613	460	306	386	698	832	154	280	1071	1117	1171
VUT 800 WH	249	613	460	306	386	698	832	154	280	1071	1117	1171
VUT 1000 EH	249	613	460	306	386	698	832	154	280	1071	1117	1171
VUT 1000 WH	249	613	460	306	386	698	832	154	280	1071	1117	1171
VUT 1500 EH	314	842	581	320	520	814	947	201	595	1345	1388	1445
VUT 1500 WH	314	842	581	320	520	814	947	201	595	1345	1388	1445
VUT 2000 EH	314	842	581	320	520	814	947	201	595	1345	1388	1445
VUT 2000 WH	314	842	581	320	520	814	947	201	595	1345	1388	1445

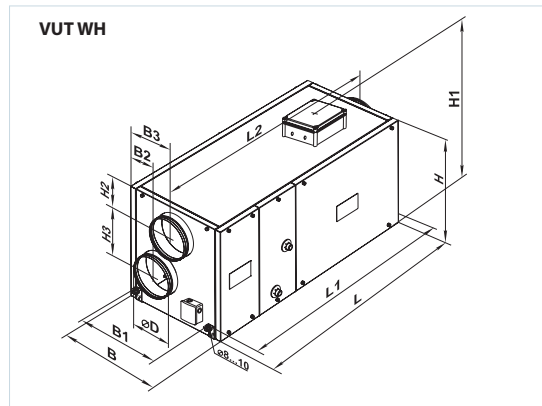
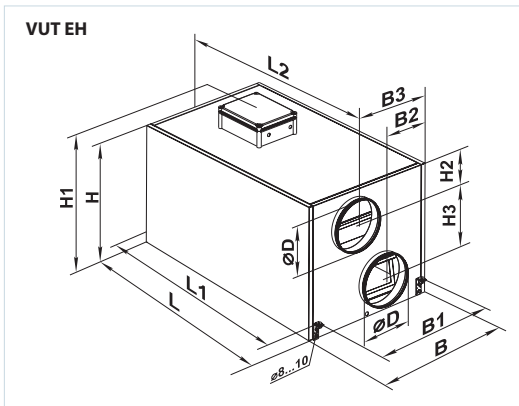

Accessories for air handling units

Model	G4 panel filter	Silencers		Back valves	Air dampers	Clamps	Summer blocks
VUT 350 EH	SF 438x215x48 G4	SR 125 600/900/1200	SRF 125 600/900/1200	KOM 125	KR 125	C 125	VL C4 300/300
VUT 500 EH		SR 150 600/900/1200	SRF 150 600/900/1200	KOM 150	KR 150	C 150	
VUT 530 EH		SR 160 600/900/1200	SRF 160 600/900/1200	KOM 160	KR 160	C 160	
VUT 600 EH		SR 200 600/900/1200	SRF 200 600/900/1200	KOM 200	KR 200	C 200	
VUT 800 EH	SF 550x253x48 G4	SR 250 600/900/1200	SRF 250 600/900/1200	KOM 250	KR 250	C 250	VL C4 300/300*2
VUT 1000 EH		SR 250 600/900/1200	SRF 250 600/900/1200	KOM 250	KR 250	C 250	VL C4 300/300*2
VUT 1500 EH	SF 780x273x48 G4	SR 315 600/900/1200	SRF 315 600/900/1200	KOM 315	KR 315	C 315	VL C4 300/384
VUT 2000 EH		SR 315 600/900/1200	SRF 315 600/900/1200	KOM 315	KR 315	C 315	VL C4 300/384
VUT 800 WH-4	SF 550x253x48 G4	SR 250 600/900/1200	SRF 250 600/900/1200	KOM 250	KR 250	C 250	VL C4 300/300*2
VUT 1000 WH-4	SF 780x273x48 G4	SR 315 600/900/1200	SRF 315 600/900/1200	KOM 315	KR 315	C 315	VL C4 300/384
VUT 1500 WH-4	SF 550x253x48 G4	SR 250 600/900/1200	SRF 250 600/900/1200	KOM 250	KR 250	C 250	VL C4 300/300*2
VUT 2000 WH-4	SF 780x273x48 G4	SR 315 600/900/1200	SRF 315 600/900/1200	KOM 315	KR 315	C 315	VL C4 300/384

AIR HANDLING UNITS WITH HEAT RECOVERY

Technical data

	VUT 350 EH	VUT 500 EH	VUT 530 EH
Voltage [V/Hz]		1~230/50-60	
Maximum fan power [W]	260		300
Fan current [A]	1.2		1.32
Electric heater power [kW]	3	3	4
Electric heater current [A]	13	13	17.4
Number of water (glycol) coil rows	-	-	-
Total unit power [kW]	3.26	3.3	4.3
Total unit current [A]	14.2	14.32	18.72
Air flow [m ³ /h]	350	500	530
RPM	1150	1100	1100
Noise level at 3m [dBA]	24-45	28-47	28-47
Transported air [°C]	-25...+40	-25...+40	-25...+40
Casing material	aluzinc	aluzinc	aluzinc
Insulation		25 mm mineral wool	
Extract filter		G4	
Supply filter		G4	
Connected air duct diameter [mm]	Ø 125	Ø 150	Ø 160
Weight [kg]	45	49	49
Heat recovery efficiency	up to 78 %	up to 88 %	up to 88 %
Heat exchanger type		cross-flow type	
SEC Class		E	
Heat exchanger material		polystyrol	

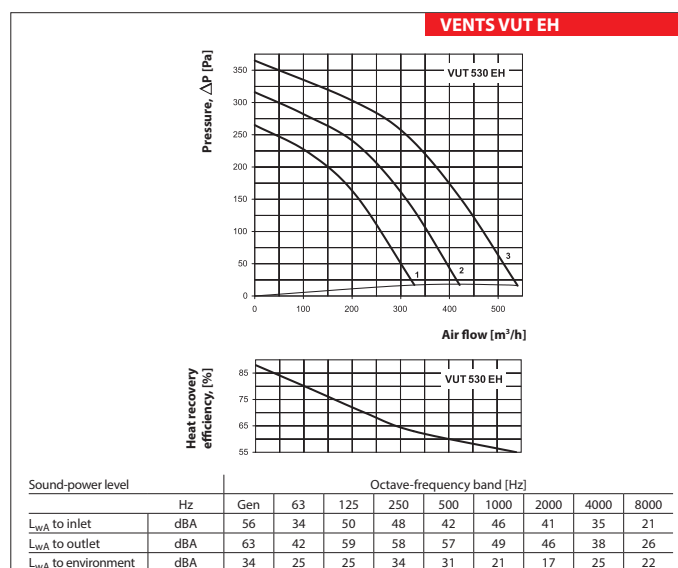
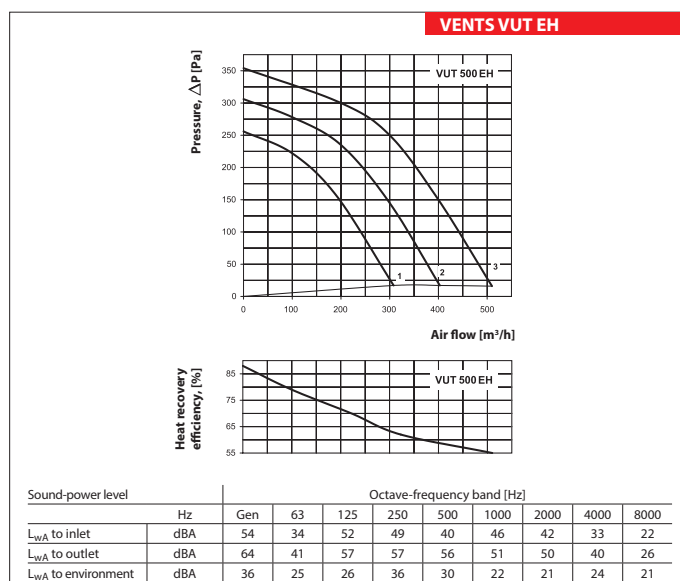
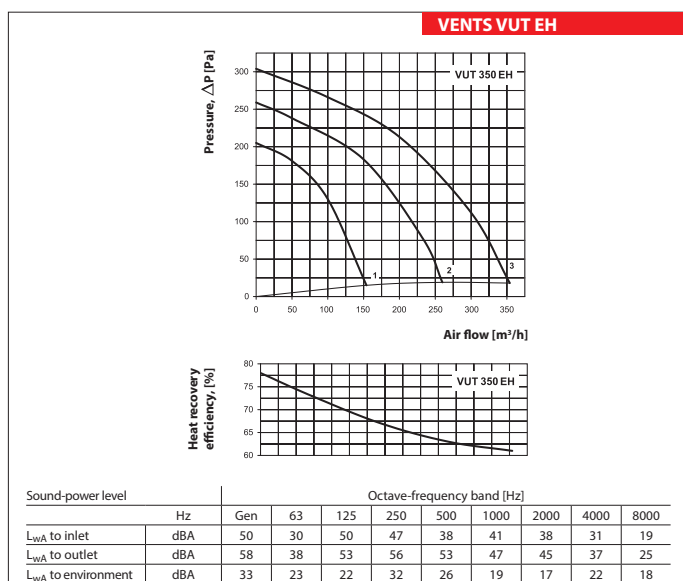

Technical data

	VUT 600 EH	VUT 800 EH	VUT 800 WH-4
Voltage [V/Hz]	1~230/50-60	3~400/50-60	1~230/50
Maximum fan power [W]	390		490
Fan current [A]	1.92		2.16
Electric heater power [kW]	4	9	-
Electric heater current [A]	17.4	13	-
Number of water (glycol) coil rows	-	-	2 or 4
Total unit power [kW]	4.39	9.49	0.49
Total unit current [A]	19.1	15.16	2.16
Air flow [m ³ /h]	600	800	780
RPM	1350		1650
Noise level at 3m [dBA]	32-48		48
Transported air [°C]	-25...+40		-25...+40
Casing material		aluzinc	
Insulation		25 mm mineral wool	
Extract filter		G4	
Supply filter		G4	
Connected air duct diameter [mm]	∅200		∅250
Weight [kg]	54	85	88
Heat recovery efficiency	up to 85 %		up to 78 %
Heat exchanger type		cross-flow type	
SEC Class		E	
Heat exchanger material		polystyrol	

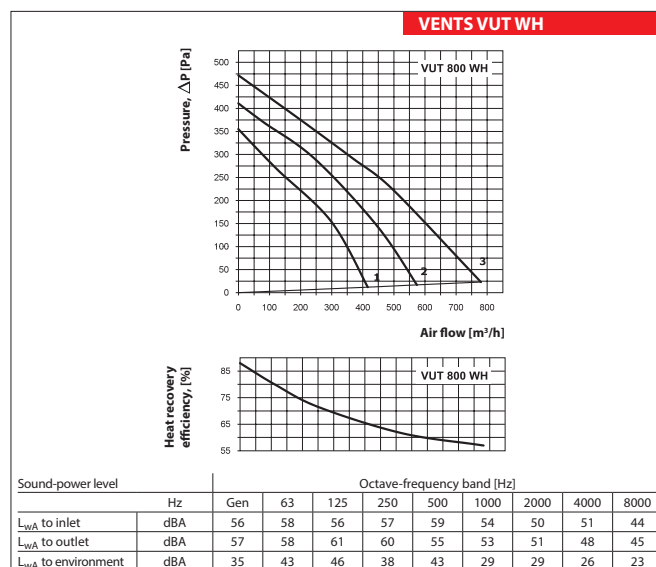
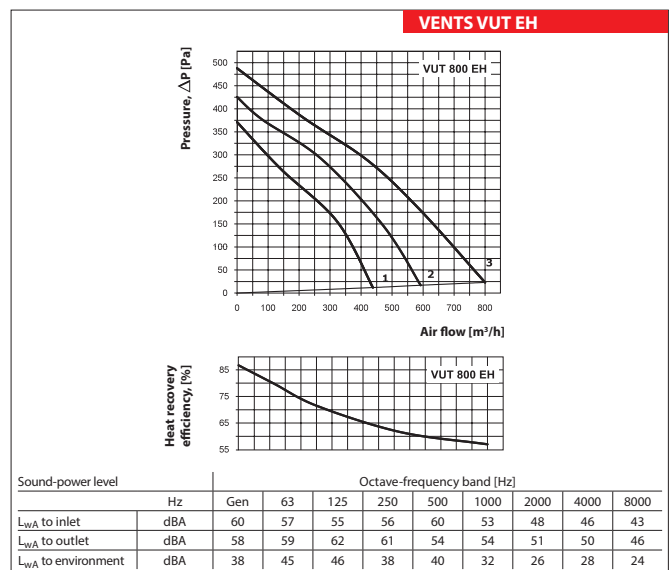
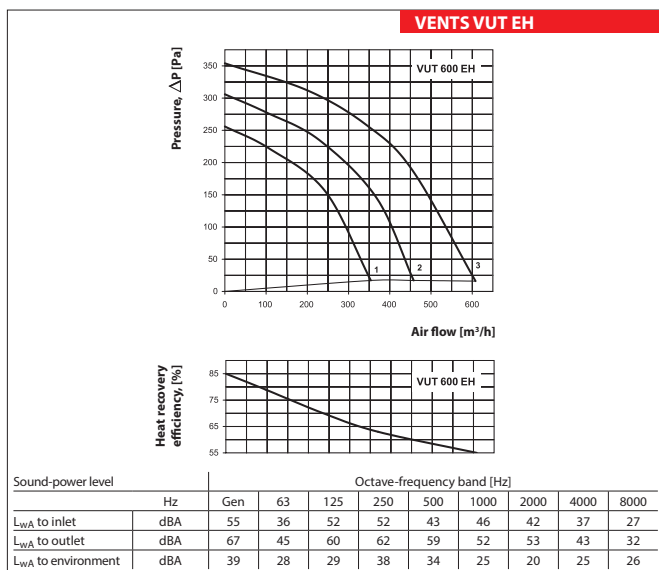

AIR HANDLING UNITS WITH HEAT RECOVERY

Technical data

	VUT 1000 EH	VUT 1000 WH-4	VUT 1500 EH
Voltage [V/Hz]	3~400/50	1~230/50	3~400/50-60
Maximum fan power [W]		820	980
Fan current [A]		3.6	4.3
Electric heater power [kW]	9	-	18
Electric heater current [A]	13	-	26
Number of water (glycol) coil rows	-	2 or 4	-
Total unit power [kW]	9.8	0.82	18.98
Total unit current [A]	16.6	3.6	30.3
Air flow [m³/h]	1200	1100	1750
RPM		1850	1100
Noise level at 3m [dBA]		60	49
Transported air [°C]		-25...+40	-25...+40
Casing material		aluzinc	
Insulation		25 mm mineral wool	
Extract filter		G4	
Supply filter		G4	
Connected air duct diameter [mm]		Ø 250	Ø 315
Weight [kg]	85	88	96
Heat recovery efficiency		up to 78 %	up to 77 %
Heat exchanger type		cross-flow type	
Heat exchanger material		polystyrol	

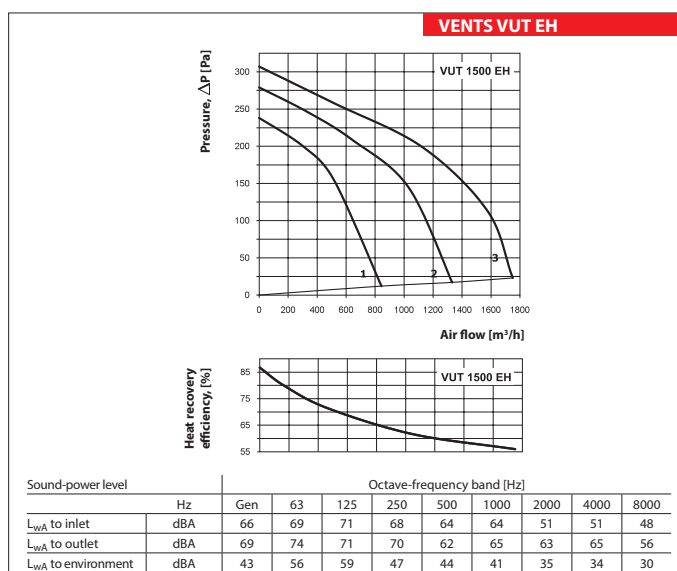
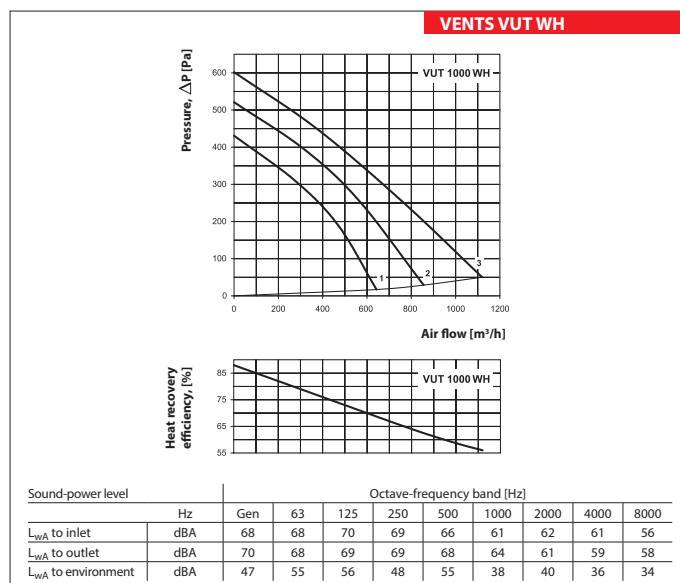
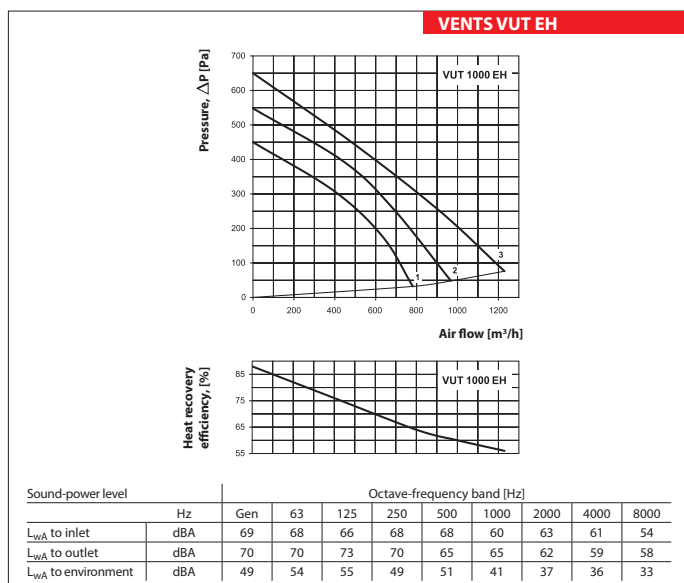

Technical data

	VUT 1500 WH-4	VUT 2000 EH	VUT 2000 WH-4
Voltage [V/Hz]	1~230/50	3~400/50-60	1~230/50
Maximum fan power [W]	980		1300
Fan current [A]	4.3		5.68
Electric heater power [kW]	–	18	–
Electric heater current [A]	–	26	–
Number of water (glycol) coil rows	2 or 4	–	2 or 4
Total unit power [kW]	0.98	19.3	1.3
Total unit current [A]	4.3	31.7	5.68
Air flow [m ³ /h]	1700	2200	2100
RPM	1100		1150
Noise level at 3m [dBA]	49		65
Transported air [°C]	-25...+40		-25...+40
Casing material		aluzinc	
Insulation		25 mm mineral wool	
Extract filter		G4	
Supply filter		G4	
Connected air duct diameter [mm]		Ø315	
Weight [kg]	99	96	99
Heat recovery efficiency		up to 77 %	
Heat exchanger type		cross-flow type	
Heat exchanger material		polystyrol	

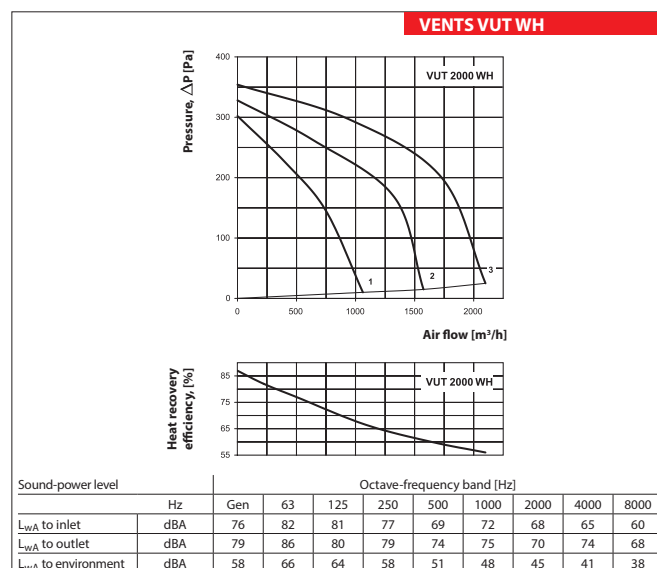
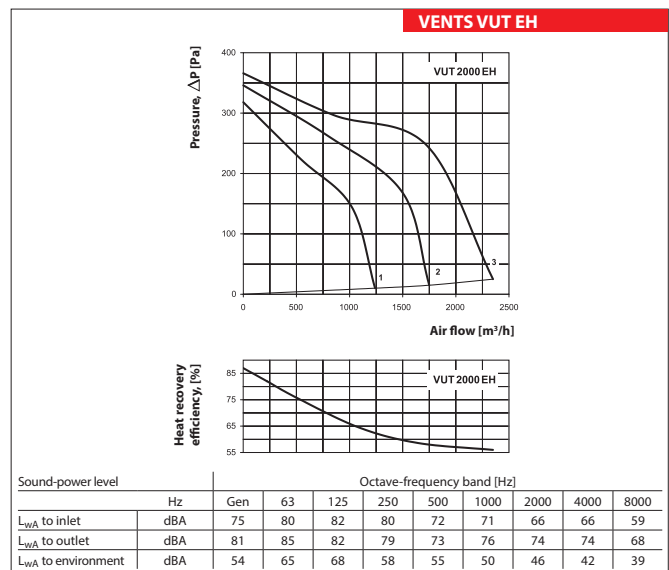
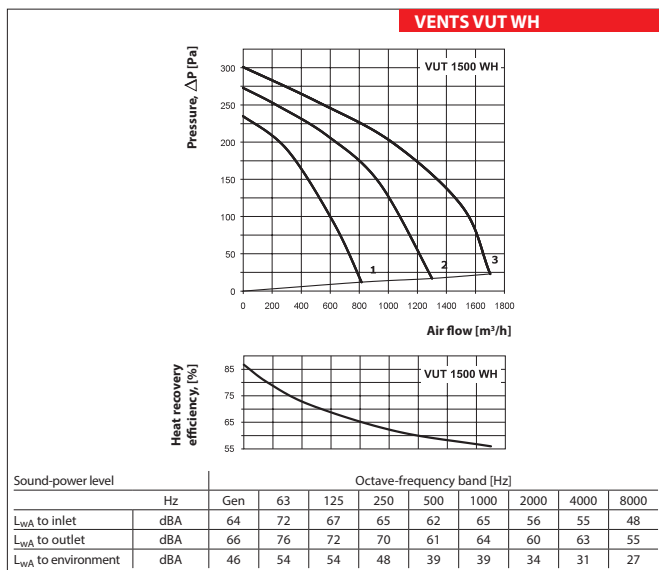

Hot water coil parameters

VENTS VUT WH

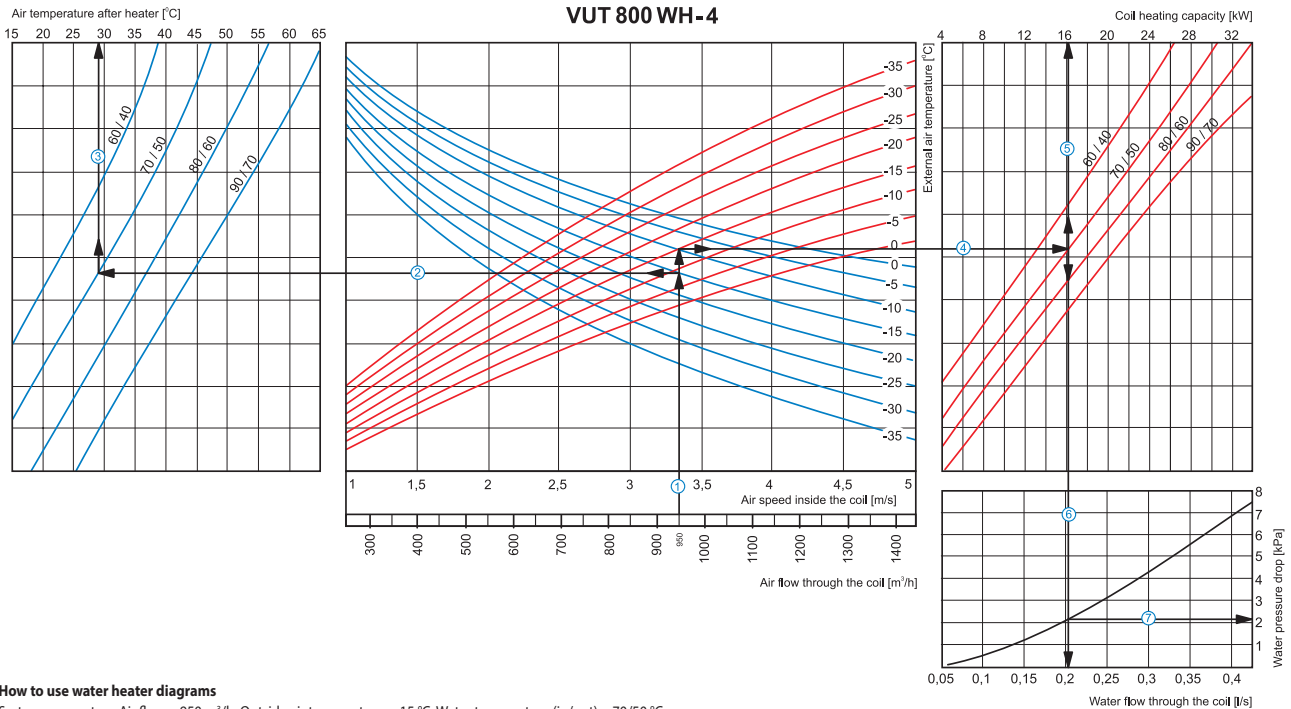

How to use water heater diagrams

System parameters: Air flow = 950 m³/h. Outside air temperature = -15 °C. Water temperature (in/out) = 70/50 °C.

- Air Speed. Starting from 950 m³/h on the air flow scale draw a vertical line ① till the air speed axis which makes about 3.35 m/s.
- Supply air temperature. Prolong the line ① up to the point where it crosses the outside air temperature (blue curve, e.g. -15 °C); then draw a horizontal line ② from this point to the left till crossing water in/out temperature curve (e.g. 70/50 °C). From this point draw a vertical line ③ to the supply air temperature axis on top of the graphic (+29 °C).
- Heating coil capacity. Prolong the line ① up to the point where it crosses the outside air temperature (e.g. -15 °C, red curve) and draw a horizontal line ④ from this point to the right until it crosses water in/out temperature curve (e.g., 70/50 °C), from here draw a vertical line ⑤ up to the scale representing the heating coil capacity (16.0 kW).
- Water flow. Prolong the line ⑤ down to water flow axis at the bottom of the graphic ⑥ (0.2 l/s).
- Water pressure drop. Draw the line ⑦ from the point where the line ⑥ crosses the black curve to the pressure drop axis. (2.1 kPa).

VENTS VUT WH

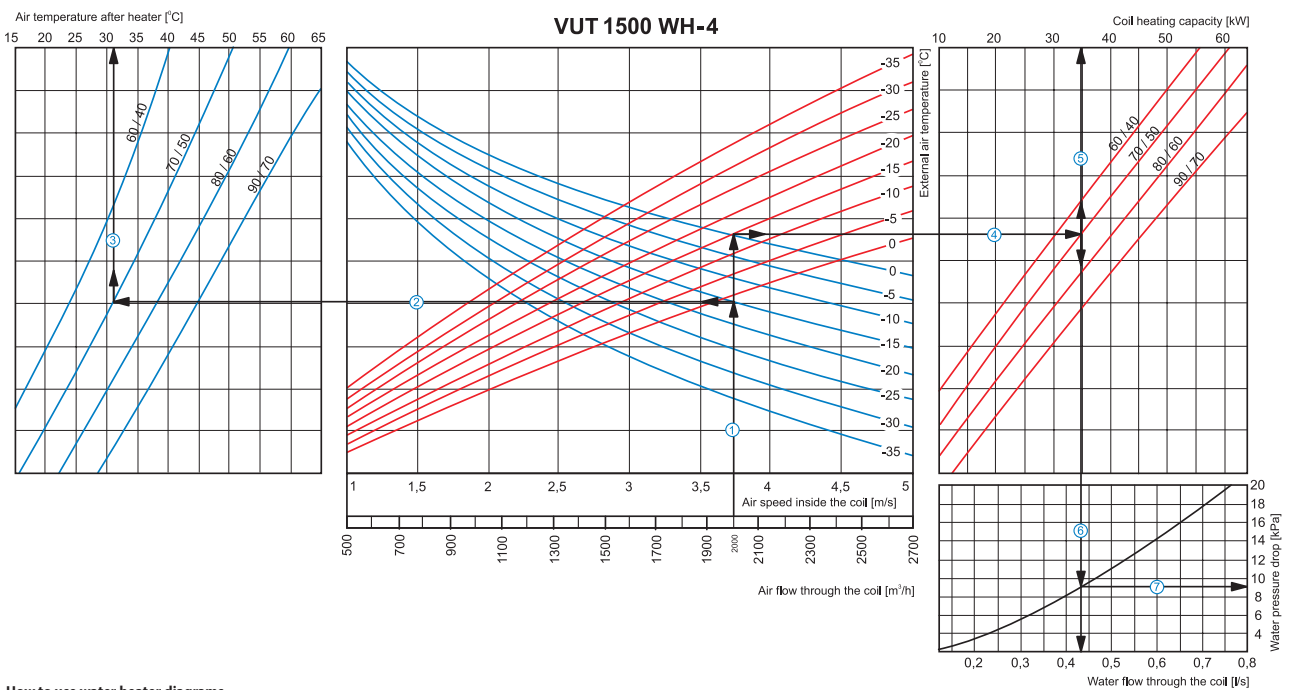

How to use water heater diagrams

System Parameters: Air flow = 2000 m³/h. Outside air temperature = -15 °C. Water temperature (in/out) = 70/50 °C.

- Air Speed. Starting from 2000 m³/h on the air flow scale draw a vertical line ① till the air speed axis which makes about 3.75 m/s.
- Supply air temperature. Prolong the line ① up to the point where it crosses the outside air temperature (blue curve, e.g. -15 °C); then draw a horizontal line ② from this point to the left till crossing water in/out temperature curve (e.g. 70/50 °C). From this point draw a vertical line ③ to the supply air temperature axis on top of the graphic (+31 °C).
- Heating coil capacity. Prolong the line ① up to the point where it crosses the outside air temperature (e.g. -15 °C, red curve) and draw a horizontal line ④ from this point to the right until it crosses water in/out temperature curve (e.g., 70/50 °C), from here draw a vertical line ⑤ up to the scale representing the heating coil capacity (35.0 kW).
- Water flow. Prolong the line ⑤ down to water flow axis at the bottom of the graphic ⑥ (0.43 l/s).
- Water pressure drop. Draw the line ⑦ from the point where the line ⑥ crosses the black curve to the pressure drop axis. (9.0 kPa).

Hot water coil parameters

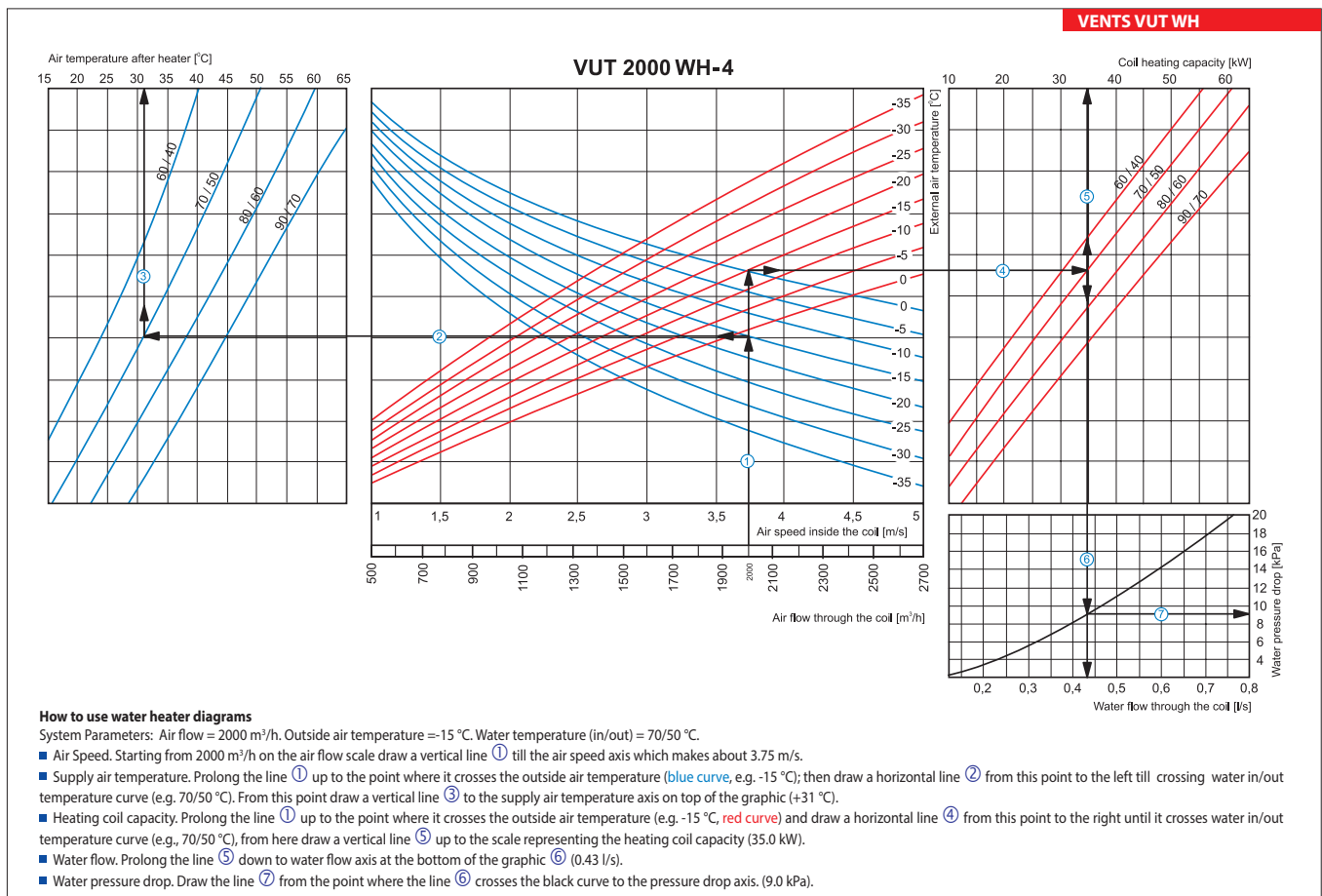
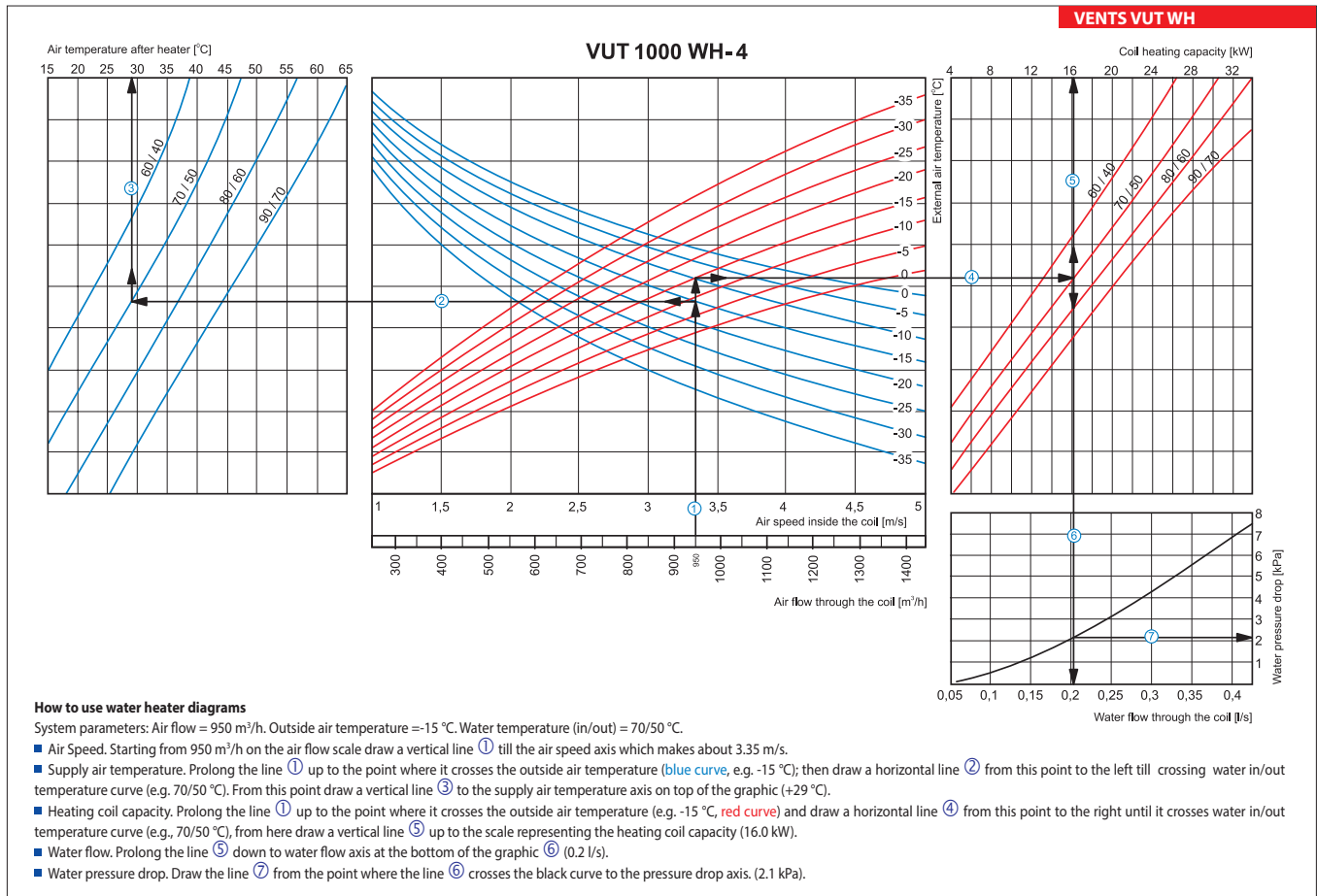

Series
VENTS VUTR VE EC



Air handling units in heat- and sound-insulated casing.
Air flow up to **670 m³/h**.
Heat recovery efficiency up to **92 %**.

Description

The VUTR VE EC air handling units are the fully-featured ventilation units that ensure air filtration, fresh air supply and stale air extraction.

Used in ventilation that require an economical solution and a controlled ventilation system.

Casing

Made of polymer-coated steel, internally filled with a mineral wool heat- and sound-insulating layer.

Kitchen hood

All units are equipped with a 5th spigot for connection of a kitchen hood (see the «Application options» section).

The distinctive feature of the VUTR 200 VE2 EC unit is the ability to connect a KH-1 kitchen hood (available upon separate order) directly to the unit.



Filter

The two integrated G4 and F7 filters ensure sufficient intake air purification.

Extract air is cleaned by the integrated G4 filter.

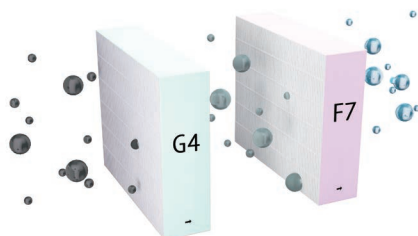

Motor

The units are equipped with high-efficient EC motors with an external rotor and a centrifugal impeller.

These state-of-the-art motors offer the very best in energy efficiency today.

Rotary heat exchanger

Unit equipped with a rotary heat exchanger. As compared to plate heat exchangers, the rotary heat exchangers are distinguished with no condensate forming, ability to maintain comfortable air humidity and extremely low freezing danger.

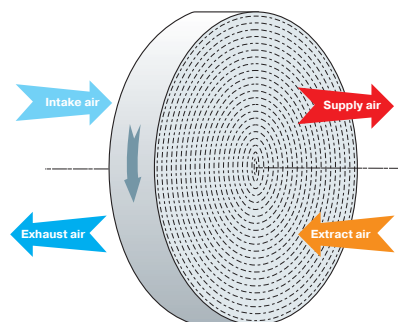

Rotary heat exchanger operation principle

Heater

Units are equipped with an electric heater. The heaters are equipped with protecting devices to ensure safe and reliable operation of the unit.

Automation

The VUTR V(2)E EC 21 units are equipped with an integrated control system. The A21 controller allows integrating the unit into the Smart Home system or BMS (Building Management Systems). To control the unit using a mobile application via Wi-Fi, you need to download the VENTS Home mobile application.

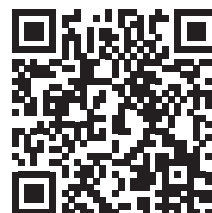

Google play



Download on the App Store



Mounting

The unit is designed for wall or floor mounting.



The access for unit and filter maintenance is available from the front panel.

The service and the back panels can be rearranged allowing connection both on the right and on the left side.

Designation key

Series	Heat exchanger type	Rated air flow [m ³ /h]	Mounting type	Insulation thickness	Heater type	Motor type	Control panel
VENTS VUT	R: rotary	200; 280; 400; 600	V: vertical	_ : 40 mm 2: 20 mm	E: with an electric heater	EC: synchronous motor with electronic control	A21

Control and automation

Functions	A21
Control via Wi-Fi using a mobile application	+
Control via a wired remote control panel	A22 (option) 
Control via a wireless remote control panel	A22 Wi-Fi (option) 
Control via a wired remote LCD control panel	A25 (option) 
BMS	RS-485 WI-FI Ethernet MODBUS (RTU, TCP)
Service Vents Cloud Server	+
Speed selection	+
Filter replacement indication	according to hour meter readings
Alarm indication	full alarm description in the mobile application
Week-scheduled operation	+
Timers	+
Boost mode	+
Fireplace mode	+
Reheater connection	integrated in E models, external reheater cannot be connected
Cooler connection	option
Kitchen hood connection	option
Minimum supply air temperature control	+
Humidity control	option
CO ₂ controller	option
VOC controller	option
Fire alarm sensor connection	option

*Option. The functionality is available when you purchase the appropriate accessory.





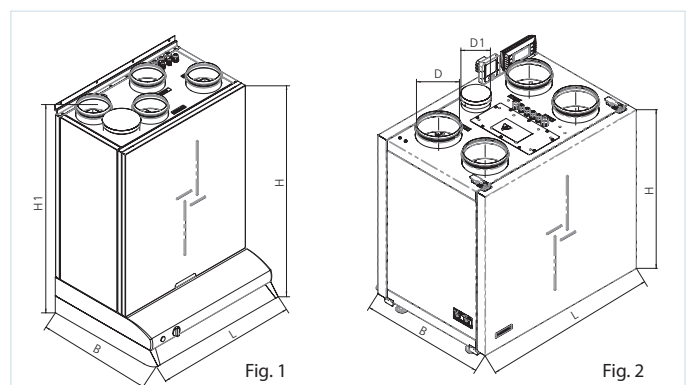



Overall dimensions

Model	Dimensions [mm]						
	Ø D	Ø D1	B	L	H	H1	Fig.
VUTR 200 V2E EC	125	-	347	600	700	901	1
VUTR 280 VE EC	122	-	508	598	630	754	2
VUTR 400 VE EC	159	99	528	745	675	755	2
VUTR 600 VE EC	199	124	628	819	772	852	2



HEAT RECOVERY AIR HANDLING UNITS

Accessories

Model	G4 panel filter	F7 panel filter	LCD control panel	Control panel	Control panel with Wi-Fi	VOC sensor 0-10 V	CO ₂ sensor 0-10 V	Humidity sensor 0-10 V	Humidity sensor NO
									
VUTR 200 V2E EC A21	SF 284x103x60 G4	SF 284x103x60 F7	A25	A22	A22 Wi-Fi	DPWQ 30600	DPWQ 40200	DPWC 11200	HR-S
VUTR 280 VE EC A21	SF 400x196x40 G4	SF 400x196x40 F7							
VUTR 400 VE EC A21	SF 436x196x40 G4	SF 436x196x40 F7							
VUTR 600 VE EC A21	SF 536x220x40 G4	SF 536x220x40 F7							

Model	Humidity sensor 0-10 V	Kitchen hood	Silencers		Back valves	Air dampers	Clamps	Electric actuator	
									
VUTR 200 V2E EC A21	HV-2	KH-1	SR 125	SRF 125	KOM 125	KRV 125	C 125	LF230	TF230
VUTR 280 VE EC A21			SR 160	SRF 160	KOM 160	KRV 160	C 160		
VUTR 400 VE EC A21			SR 200	SRF 200	KOM 200	KRV 200	C 200		
VUTR 600 VE EC A21									

Technical data

	VUTR 200 V2E EC	VUTR 280 VE EC
Unit voltage [V/50 (60) Hz]	1~230	
Max. unit power without electric heater [W]	118	195
Max. power of electric heater [W]	700	650
Max. unit power [W]	818	845
Max. unit current without electric heater [A]	1.0	1.9
Max. unit current of electric heater [A]	3.0	2,8
Max. unit current [A]	4.0	4.7
Maximum air flow [m ³ /h]	270	300
RPM [min ⁻¹]	1800	2050
Sound pressure level at 3 m distance [dBA]	28	26
Transported air temperature [°C]	-25...+40	
Casing material	painted steel	
Insulation	20 mm mineral wool	40 mm mineral wool
Filter	Extract	G4
	Intake	G4, F7
Connected air duct diameter [mm]	125	
Weight [kg]	48	64
Heat recovery efficiency	from 76 up to 92	from 81 up to 90
Heat exchanger type*	rotary	
Heat exchanger material	aluminium	
SEC class	A	

*Heat recovery efficiency is specified in compliance with EN 13141-7

Technical data

		VUTR 400 VE EC	VUTR 600 VE EC
Unit voltage [V/50 (60) Hz]		1~230	
Max. unit power without electric heater [W]		200	405
Max. power of electric heater [W]		1400	2800
Max. unit power [W]		1600	3205
Max. unit current without electric heater [A]		1.4	2.6
Max. unit current of electric heater [A]		6.1	12.2
Max. unit current [A]		7.5	14.8
Maximum air flow [m ³ /h]		440	670
RPM [min ⁻¹]		3280	3230
Sound pressure level at 3 m distance [dBA]		33	35
Transported air temperature [°C]		-25...+40	
Casing material		painted steel	
Insulation		40 mm mineral wool	
Filter	Extract	G4	
	Intake	G4, F7	
Connected air duct diameter [mm]		160	200
Weight [kg]		82	92
Heat recovery efficiency		from 76 up to 85	from 81 up to 89
Heat exchanger type*		rotary	
Heat exchanger material		aluminium	
SEC class		A	

*Heat recovery efficiency is specified in compliance with EN 13141-7

Calculation of air temperature downstream of the heat exchanger:

$$t = t_{\text{outd}} + k_{\text{hr}} * (t_{\text{extr}} - t_{\text{outd}}) / 100,$$

where

t_{outd} : outdoor air temperature [°C]

t_{extr} : extract air temperature [°C]

k_{hr} : heat exchanger efficiency (according to the diagram) [%]

Point	Total unit power [W]				Sound pressure level at 3 m (1 m) distance [dBA]			
	VUTR 200 V2E EC	VUTR 280 VE EC	VUTR 400 VE EC	VUTR 600 VE EC	VUTR 200 V2E EC	VUTR 280 VE EC	VUTR 400 VE EC	VUTR 600 VE EC
1	103	154	170	375	28 (38)	26 (36)	33 (43)	35 (45)
2	98	132	170	375	27 (37)	26 (36)	33 (43)	35 (45)
3	85	110	170	375	26 (36)	25 (35)	32 (42)	34 (44)
4	43	55	68	163	21 (31)	24 (34)	31 (41)	30 (40)
5	40	47	65	155	21 (31)	24 (34)	28 (38)	29 (39)
6	37	38	59	151	20 (30)	22 (32)	27 (37)	28 (38)
7	18	19	26	43	19 (29)	15 (25)	23 (33)	27 (37)
8	17	18	25	42	19 (29)	14 (24)	21 (31)	23 (33)
9	16	17	25	39	17 (27)	13 (23)	19 (29)	23 (33)

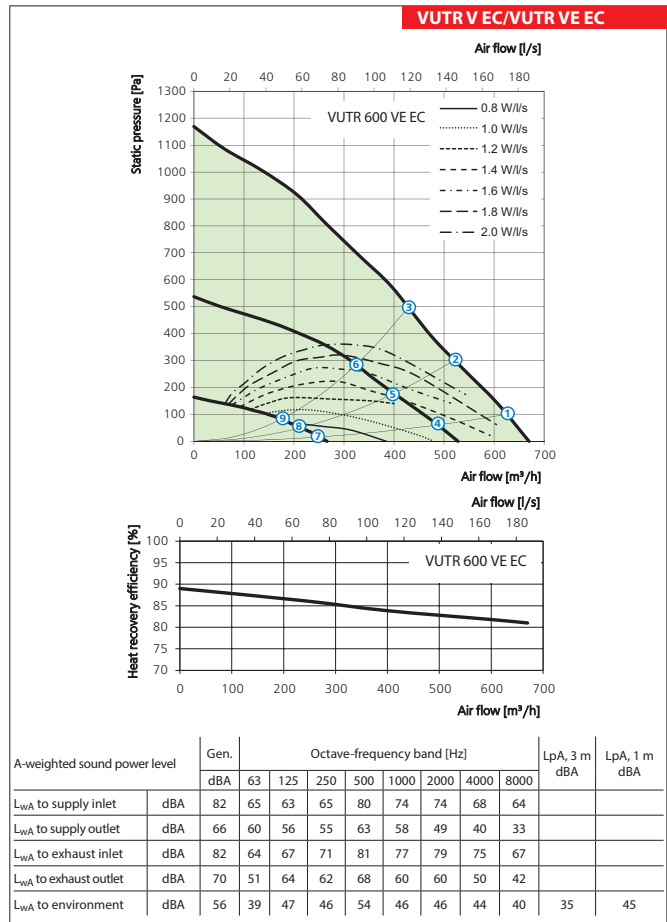
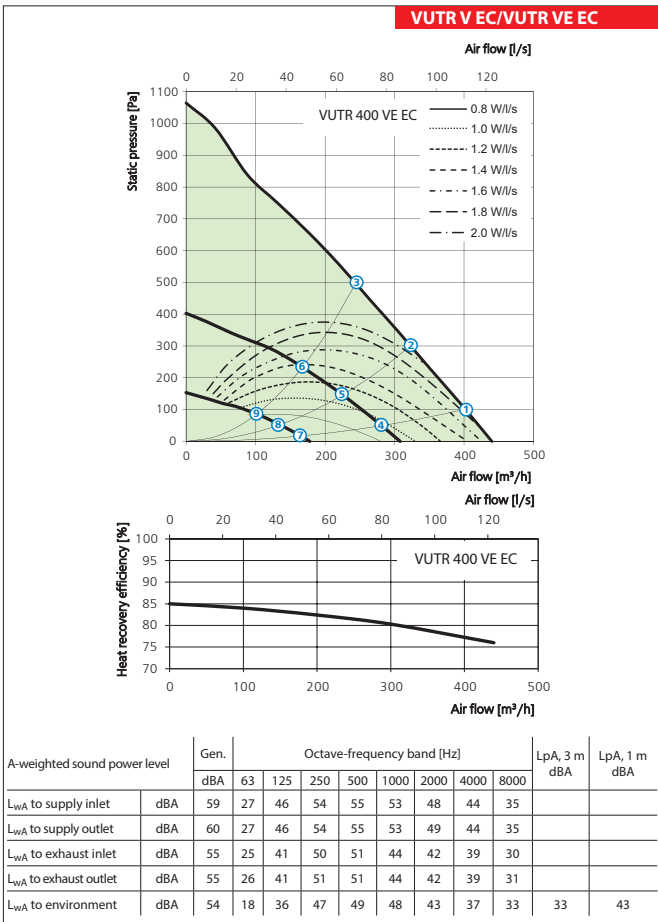
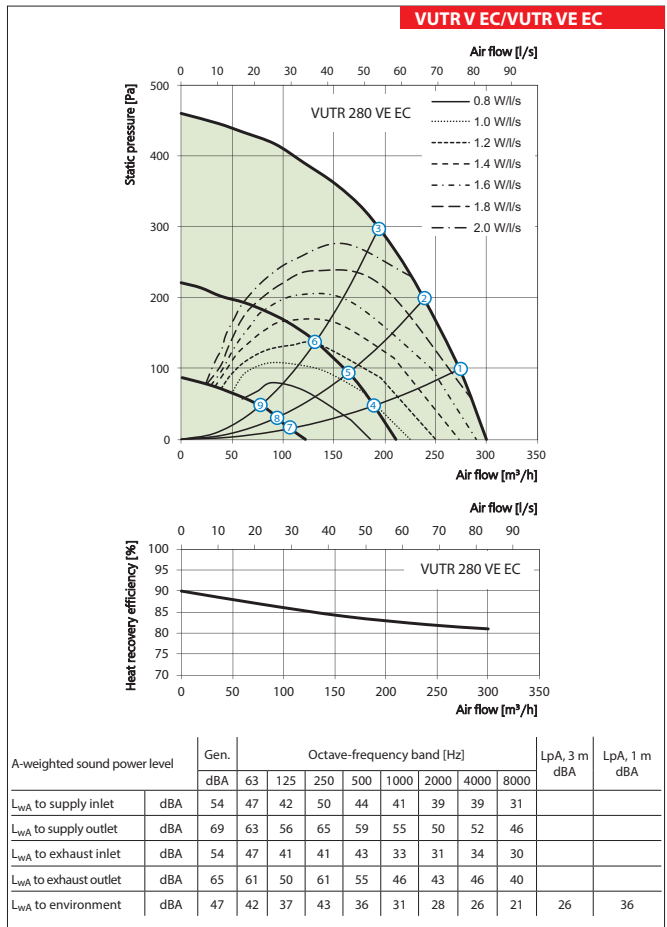
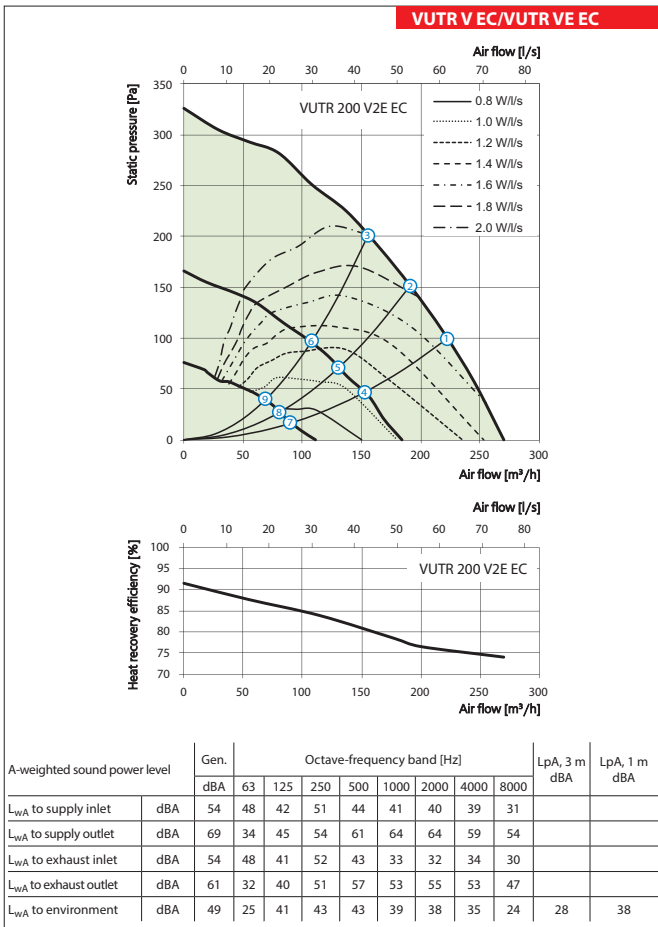

Application options

Ventilation hood



Ceiling connector with a disk valve



Isovent 150 insulated air duct

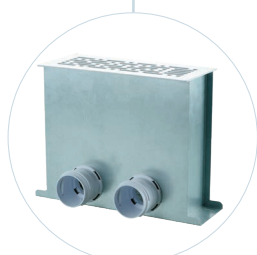
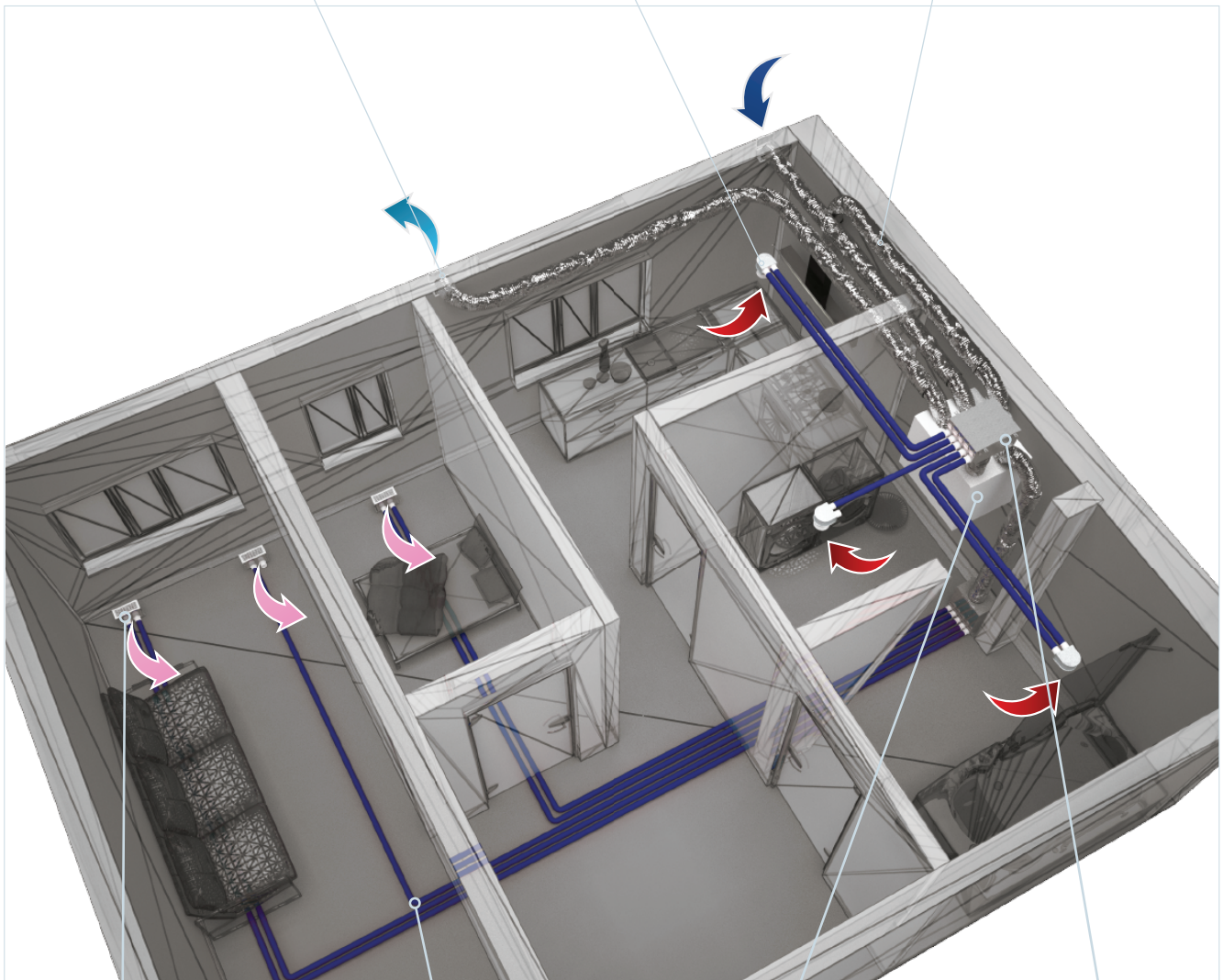

Floor connector with a grille

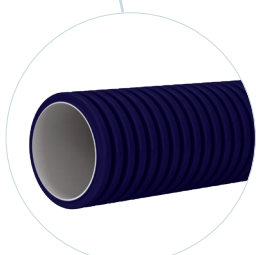

FlexiVent air duct



Air handling unit

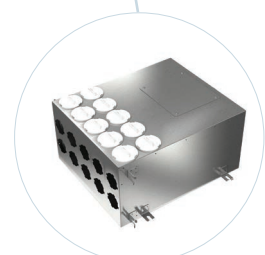

Manifold

Series
VENTS VUTR PE EC



Air handling units in heat- and sound-insulated casing.
Air flow up to **710 m³/h**.
Heat recovery efficiency up to **87 %**.

■ **Description**

The air handling units VUTR PE EC are the fully-featured ventilation units that ensure air filtration, fresh air supply and stale air extract. The units are used in ventilation systems installed in various premises that require reasonable energy saving solutions and controllable ventilation systems.

■ **Modifications**

VUTR P(2)E EC models (with an electric heater).
VUTR P2E EC models with a low profile casing and 20 mm insulation.

■ **Casing**

Made of galvanized steel, internally filled with a mineral wool heat- and sound-insulating layer. The insulation thickness is 40 mm for the VUTR PE EC models and 20 mm for the VUTR P2E EC models. Unit maintenance is performed from the bottom panel side. The distinctive feature of the VUTR P2E EC units is a low profile casing.



■ **Filter**

Two built-in filters with filtering class G4 and F7 provide efficient supply air filtration. Extract air is cleaned by the integrated G4 filter.

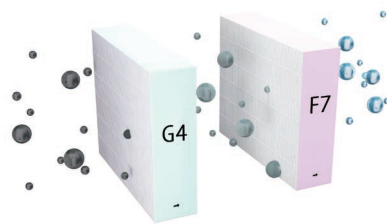

■ **Motor**

The units are equipped with high-efficient EC motors with an external rotor and a centrifugal impeller.

■ **Rotary heat exchanger**

Units equipped with a rotary heat exchanger. As compared to plate heat exchangers, the rotary heat exchangers are distinguished with no condensate forming, ability to maintain comfortable air humidity and extremely low freezing danger.

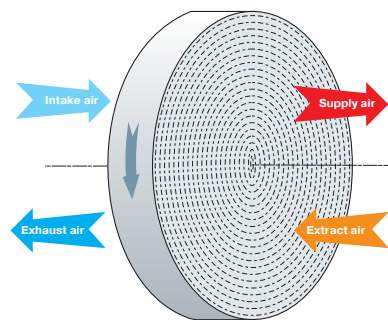

Rotary heat exchanger operation principle

■ **Heater**

The VUTR PE EC units are equipped (with an electric heater). If heat recovery is not sufficient to reach the set supply air temperature, the heater is activated to warm up supply air. The heaters are equipped with protecting devices to ensure safe and reliable operation of the unit.

■ **Automation**

The **VUTR PE/P2E EC A21** units are equipped with an integrated control system. The **A21** controller allows integrating the unit into the **Smart Home system** or **BMS (Building Management Systems)**. To control the unit using a mobile application via Wi-Fi, you need to download the VENTS Home mobile application.

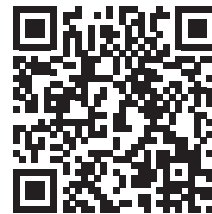

Google play



Download on the App Store





■ **Mounting**

The unit is designed for wall or floor mounting. The access for unit and filter maintenance is available from the front panel. The service and the back panels can be rearranged allowing connection both on the right and on the left side.

Designation key

Series	Heat exchanger type	Rated air flow [m ³ /h]	Spigot orientation	Casing design	Heater type	Motor type	Control panel
VENTS VUT	R: rotary	250; 350; 650	P: suspended mounting	_: standard (insulation thickness 40 mm) 2: low-profile (insulation thickness 20 mm)	E: (with an electric heater)	EC: synchronous electronically commutated motor	A21

Control and automation

Functions	A21
Control via Wi-Fi using a mobile application	+
Control via a wired remote control panel	A22 (option) 
Control via a wireless remote control panel	A22 Wi-Fi (option) 
Control via a wired remote LCD control panel	A25 (option) 
BMS	RS-485 WI-FI Ethernet MODBUS (RTU, TCP)
Service Vents Cloud Server	+
Speed selection	+
Filter replacement indication	according to hour meter readings
Alarm indication	full alarm description in the mobile application
Week-scheduled operation	+
Timers	+
Boost mode	+
Fireplace mode	+
Reheater connection	integrated in E models, external reheater cannot be connected
Cooler connection	option
Kitchen hood connection	option
Minimum supply air temperature control	+
Humidity control	option
CO ₂ controller	option
VOC controller	option
Fire alarm sensor connection	option

*Option. The functionality is available when you purchase the appropriate accessory.

Overall dimensions

Model	Dimensions [mm]					
	Ø D	Ø D1	L1	L	B	H
VUTR 250 PE EC	160	125	1100	1003	688	345
VUTR 250 P2E EC	160	125	1097	1002	666	245
VUTR 350 PE EC	160	125	1365	1270	818	361
VUTR 350 P2E EC	160	125	1457	1362	847	245
VUTR 650 PE EC	200	125	1542	1445	932	422

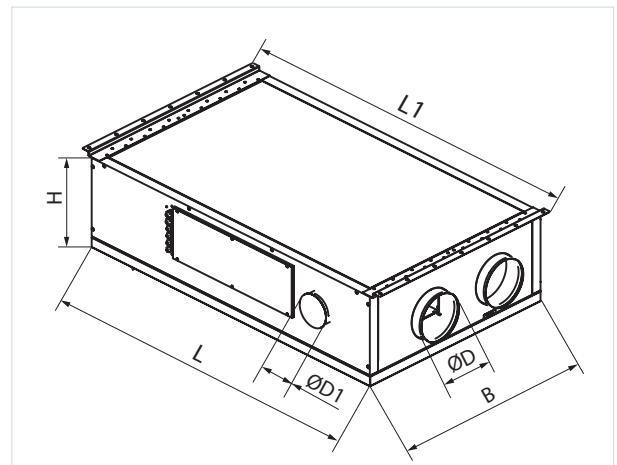

HEAT RECOVERY AIR HANDLING UNITS

Technical data

	VUTR 250 P2E EC	VUTR 250 PE EC
Unit voltage [V/50 (60) Hz]	1~220-240	
Maximum unit power (without an electric heater) [W]	128	135
Maximum unit power (with an electric heater) [W]	828	835
Maximum unit current (without an electric heater) [A]	0.9	1.0
Maximum unit current (with an electric heater) [A]	4.0	4.1
Maximum air flow [m ³ /h]	300	310
RPM [min ⁻¹]	2200	2200
Sound pressure level at 3 m distance [dBA]	23	21
Transported air temperature [°C]	-25...+40	
Casing material	galvanized steel	
Insulation	20 mm mineral wool	40 mm mineral wool
Extract filter	G4	
Supply filter	G4, F7	
Connected air duct diameter [mm]	160	
Weight [kg]	54	56
Heat recovery efficiency [%]	from 76 up to 87	from 71 up to 87
Heat exchanger type	rotary	
Heat exchanger material	aluminium	
SEC class	A	

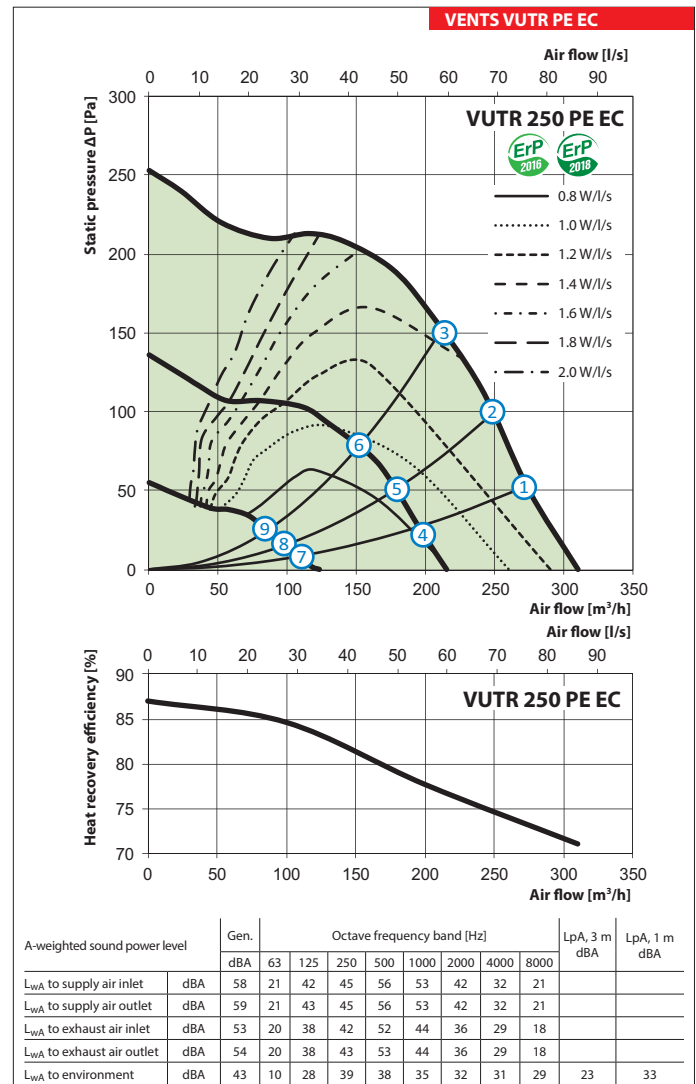
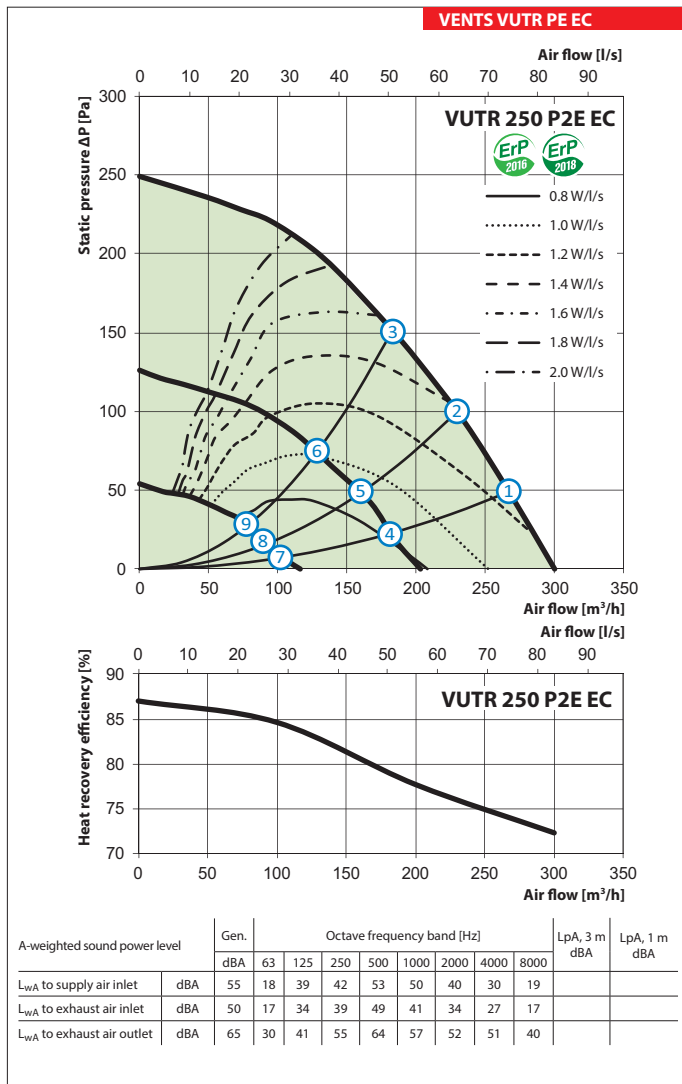

	VUTR 350 P2E EC	VUTR 350 PE EC
Unit voltage [V/50 (60) Hz]	1~220-240	
Maximum unit power (without an electric heater) [W]	200	185
Maximum unit power (with an electric heater) [W]	1600	1585
Maximum unit current (without an electric heater) [A]	1.3	
Maximum unit current (with an electric heater) [A]	6.9	6.9
Maximum air flow [m ³ /h]	400	430
RPM [min ⁻¹]	3200	3570
Sound pressure level at 3 m distance [dBA]	33	31
Transported air temperature [°C]	-25...+40	
Casing material	galvanized steel	
Insulation	20 mm mineral wool	40 mm mineral wool
Extract filter	G4	
Supply filter	G4, F7	
Connected air duct diameter [mm]	160	
Weight [kg]	79	82
Heat recovery efficiency [%]	from 73 up to 87	from 72 up to 87
Heat exchanger type	rotary	
Heat exchanger material	aluminium	
SEC class	A	

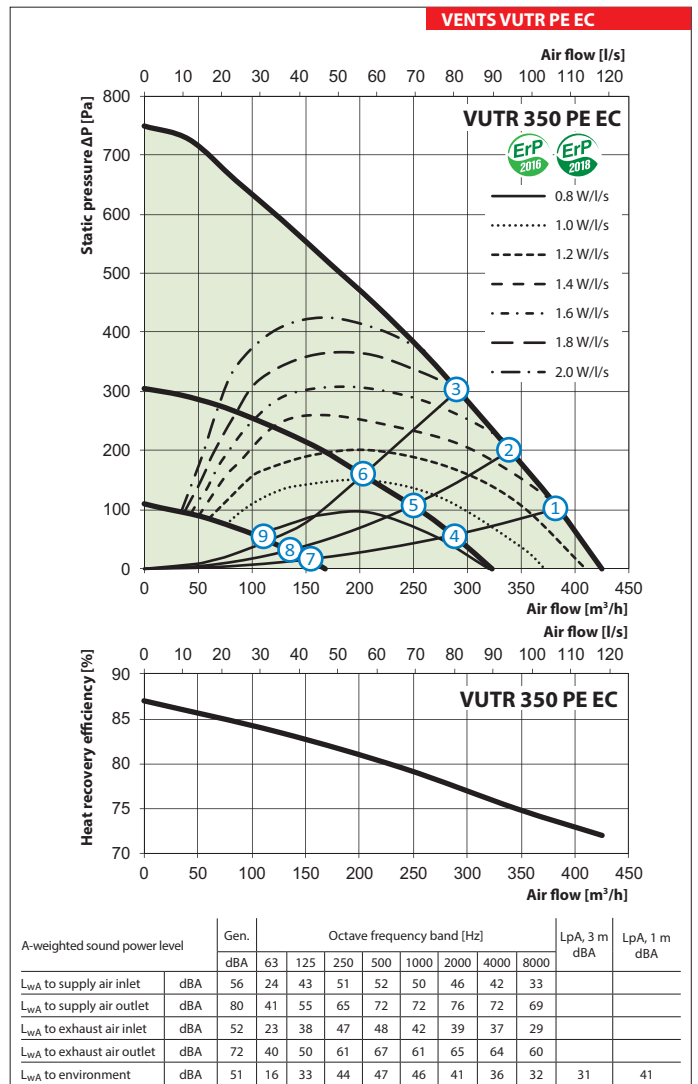
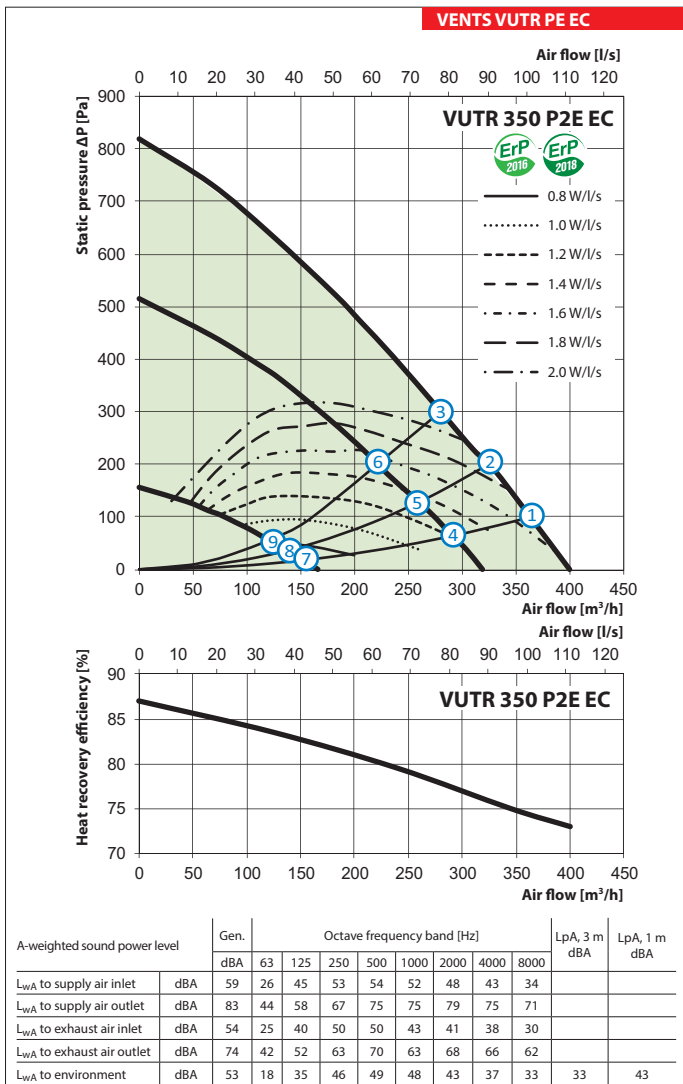

HEAT RECOVERY AIR HANDLING UNITS

Technical data

		VUTR 650 PE EC
Unit voltage [V/50 (60) Hz]		1~220-240
Maximum unit power (without an electric heater) [W]		367
Maximum unit power (with an electric heater) [W]		3167
Maximum unit current (without an electric heater) [A]		2.5
Maximum unit current (with an electric heater) [A]		13.7
Maximum air flow [m ³ /h]		710
RPM [min ⁻¹]		3600
Sound pressure level at 3 m distance [dBA]		36
Transported air temperature [°C]		-25...+40
Casing material		galvanized steel
Insulation		40 mm mineral wool
Extract filter		G4
Supply filter		G4, F7
Connected air duct diameter [mm]		200
Weight [kg]		104
Heat recovery efficiency [%]		from 80 up to 87
Heat exchanger type		rotary
Heat exchanger material		aluminium
SEC class		A

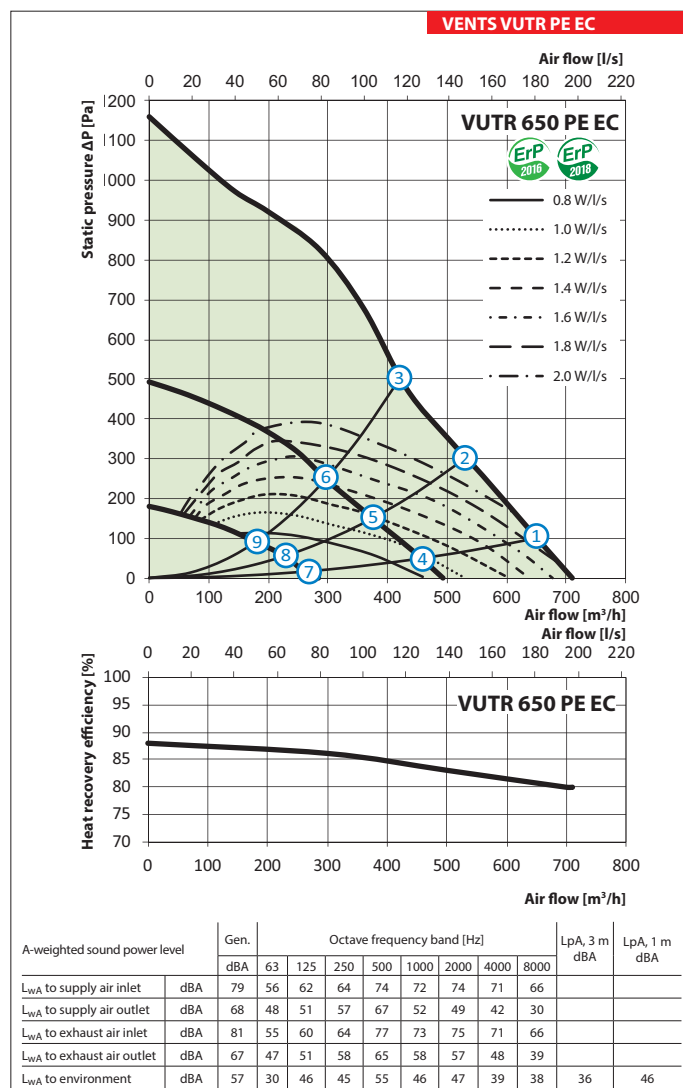

Point	Power [W]				
	VUTR 250 P2E EC	VUTR 250 PE EC	VUTR 350 P2E EC	VUTR 350 PE EC	VUTR 650 PE EC
1	93	101	172	154	342
2	89	115	171	151	342
3	77	80	167	149	342
4	41	45	125	116	122
5	39	42	124	116	122
6	38	40	122	115	122
7	17	17	98	76	34
8	17	17	97	75	33
9	16	16	97	63	33

Sound pressure level at 3 m distance [dBA]				
VUTR 250 P2E EC	VUTR 250 PE EC	VUTR 350 P2E EC	VUTR 350 PE EC	VUTR 650 PE EC
23 (33)	21 (31)	33 (43)	31 (41)	36 (46)
23 (33)	21 (31)	33 (43)	31 (41)	36 (46)
22 (32)	20 (30)	32 (42)	30 (40)	35 (45)
21 (31)	18 (28)	31 (41)	27 (37)	31 (41)
19 (29)	17 (27)	28 (38)	26 (36)	29 (39)
18 (28)	17 (27)	27 (37)	26 (36)	29 (39)
18 (28)	16 (26)	27 (37)	24 (34)	27 (37)
17 (27)	16 (26)	23 (33)	21 (31)	24 (34)
17 (27)	16 (26)	23 (33)	21 (31)	24 (34)

Accessories

Model	G4 panel filter	F7 panel filter	LCD control panel	Control panel	Control panel with Wi-Fi	VOC sensor (0-10 V)	CO ₂ sensor (0-10 V)
VUTR 250 P2E EC A21	SF 280x180x48 G4	SF 280x180x48 F7					
VUTR 250 PE EC A21	SF 260x220x48 G4	SF 260x220x48 F7					
VUTR 350 P2E EC A21	SF 372x180x48 G4	SF 372x180x48 F7	A25	A22	A22 Wi-Fi	DPWQ30600	DPWQ40200
VUTR 350 PE EC A21	SF 320x235x48 G4	SF 320x235x48 F7					
VUTR 650 PE EC A21	SF 378x295x48 G4	SF 378x295x48 F7					

Model	Humidity sensor (0-10 V)	Humidity sensor (NO)	Humidity sensor (0-10 V)	Kitchen hood	Back valves	Air dampers	Clamps	Electric actuator	
VUTR 250 P2E EC A21									
VUTR 250 PE EC A21									
VUTR 350 P2E EC A21	DPWC11200	HR-S	HV-2	KH-1	KOM 160	KRV 160	C 160	LF230	TF230
VUTR 350 PE EC A21									
VUTR 650 PE EC A21					KOM 200	KRV 200	C 200		

Application options

Ceiling connector with a disc valve

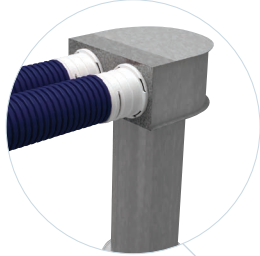

Manifold

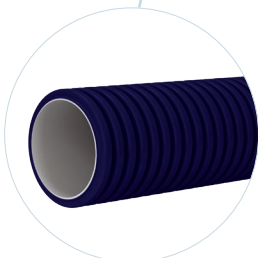
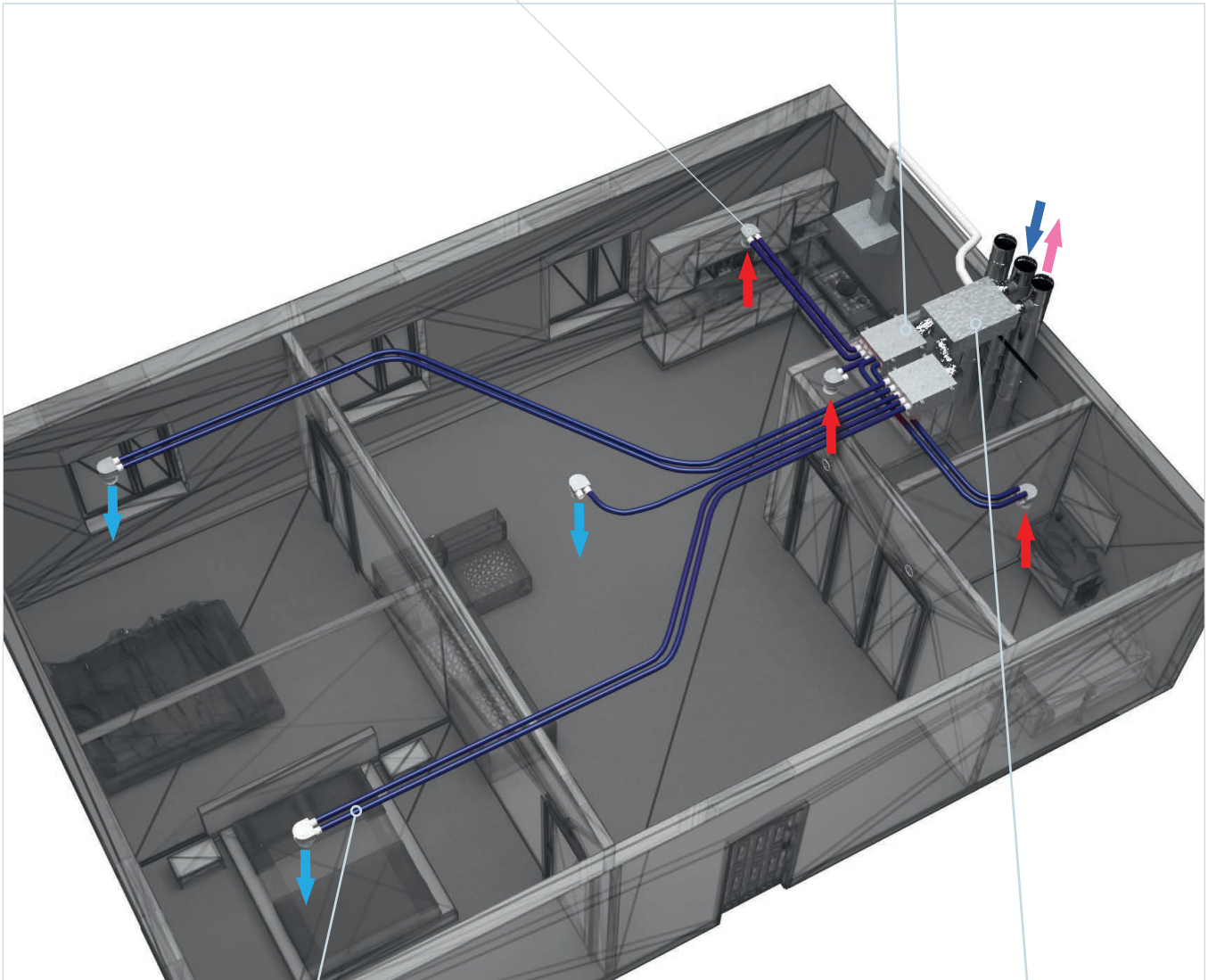
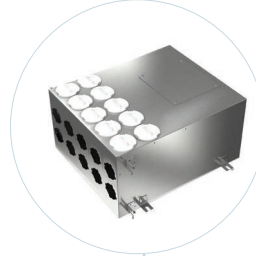

FlexiVent air duct

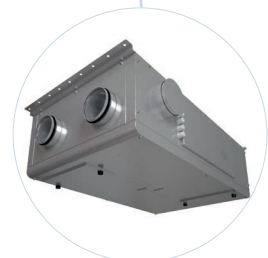

Air handling unit

Series
VUTR 400 EH EC/WH EC
VUTR 700 EH EC/WH EC
VUTR 900 EH EC/WH EC



Series
VUTR 1200 EH EC/WH EC
VUTR 1500 EH EC/WH EC



Series
VUTR 2000 EH EC/WH EC



Air handling units in heat- and sound-insulated casing with an electric or a water heater.
 Air flow up to **2250 m³/h**.
 Heat recovery efficiency up to **95 %**

Description

The air handling units VUTR EH EC with an electric heater and VUTR WH EC with a water heater are the fully-featured ventilation units that ensure air filtration, fresh air supply and stale air extract. Used in ventilation and air conditioning systems in commercial, office and other public or industrial premises that require an economical solution and a controlled ventilation system.

Modifications

VUTR EH EC models are equipped with an electric heater.

VUTR WH EC models are equipped with a water heater.

Casing

The casing consists of a frame and three-layer 20 mm (VUTR 1500 and 2000 – 25 mm) thick panels made of zinc aluminium internally filled with mineral wool for reliable heat- and sound-insulation.

Filter

The two integrated G4 filters ensure sufficient supply and extract air purification.

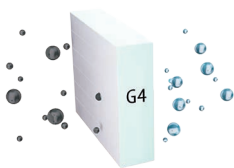

Motor

The air handling units are equipped with high-efficiency electronically commutated (EC) direct current motors with an external rotor and backward-curved blades.

Rotary heat exchanger

Units equipped with a rotary heat exchanger. As compared to plate heat exchangers, the rotary heat exchangers are distinguished with no condensate forming, ability to maintain comfortable air humidity and extremely low freezing danger.

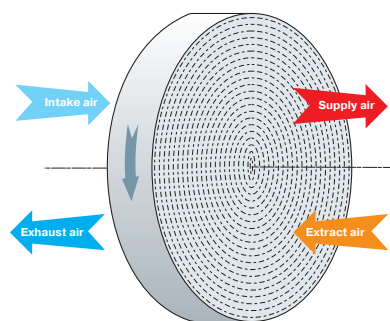

Rotary heat exchanger operation principle

Heater

The air handling units are equipped with electric heaters (VUTR EH EC models) or water heaters (VUTR WH EC models) to operate at low outside temperatures. The heaters are equipped with protecting devices to ensure safe and reliable operation of the unit.

Control and automation

The VUTR EH EC A17 and VUTR WH EC A17 units are equipped with a th-Tune control panel.



The VUTR EH EC A18 and VUTR WH EC A18 units are equipped with a pGD1 control panel.



Designation key

Series	Heat exchanger type	Rated air flow [m ³ /h]	Heater type	Pipe modification	Motor type	Control panel
VENTS VUT	R: rotary heat exchanger	400; 700; 900; 1200; 1500; 2000	E: electric W: water	H: horizontal	EC: synchronous motor with electronic control	A17: th-Tune A18: pGD1

Automation functions

- ▶ Speed selection: low, medium, high.
- ▶ Speed is individually adjusted from 0 to 100 % for the supply and the extract fans.
- ▶ Filter maintenance indication.
- ▶ Alarm indication.
- ▶ Timer-based operation.
- ▶ Week-scheduled operation.
- ▶ Supply air temperature control.
- ▶ CCU control.
- ▶ Air damper actuator controlling.

Overall dimensions

Model	Dimensions [mm]								
	øD	A	E	F	G	L	L1	H	J
VUTR 400 EH EC/400 WH EC	159	1050	225	167	333	648	200	670	440
VUTR 700 EH EC/700 WH EC	249	1210	243	180	340	745	260	700	580
VUTR 900 EH EC/900 WH EC	249	1210	243	180	340	745	260	700	580
VUTR 1200 EH EC/1200 WH EC	314	1335	373	220	438	745	-	880	460
VUTR 1500 EH EC/1500 WH EC	314	1430	427	275	460	855	-	1010	560
VUTR 2000 EH EC/2000 WH EC	-	1485	-	-	-	875	-	1010	630

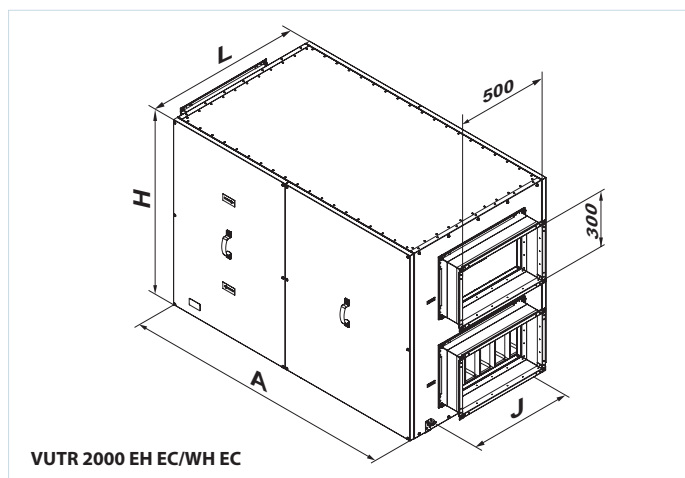
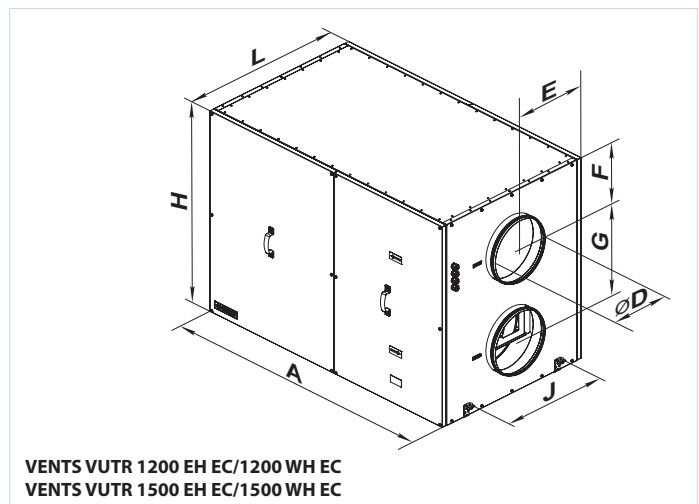
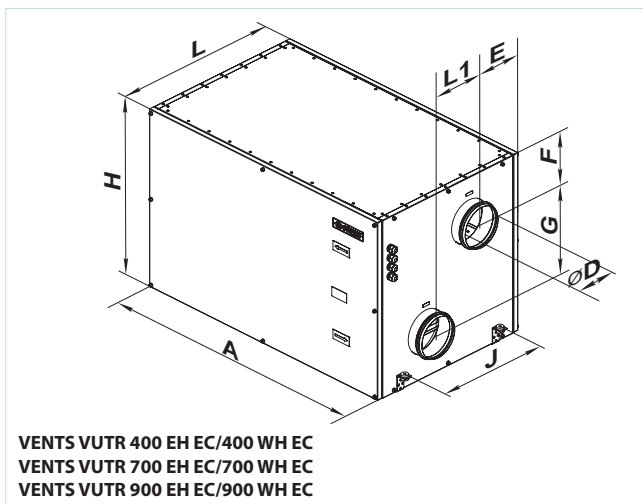

AIR HANDLING UNITS WITH HEAT RECOVERY

Technical data

	VUTR 400 EH EC	VUTR 400 WH EC	VUTR 700 EH EC	VUTR 700 WH EC	VUTR 900 EH EC	VUTR 900 WH EC
Voltage [V]	1~230		1~230		3~400	1~230
Maximum fan power [W]	200		210		270	
Electric heater power [kW]	2	-	3.3	-	4.5	-
Total unit power [W]	2290	290	3615	315	4940	440
Total unit current [A]	9.9	1.2	15.8	1.4	7.2	1.9
Maximum air flow [m³/h]	400		700		900	
RPM	up to 3100		up to 2600		up to 2600	
Sound pressure level at 3 m distance [dBA]	45		52		58	
Transported air temperature [°C]	-25...+40					
Casing material	Aluzinc					
Insulation	20 mm mineral wool					
Extract filter	G4					
Supply filter	G4					
Connected air duct diameter [mm]	Ø160		Ø250		Ø250	
Mass [kg]	112		128		130	
Heat recovery efficiency [%]	80-95		76-95		72-95	
Heat exchanger type	rotary					
Heat exchanger material	aluminium					
SEC class	A					

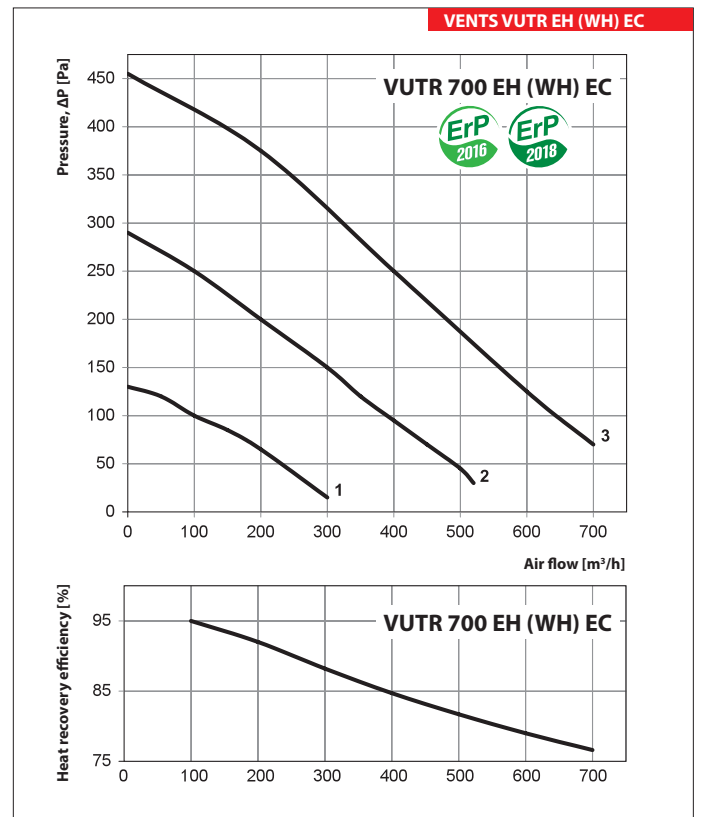
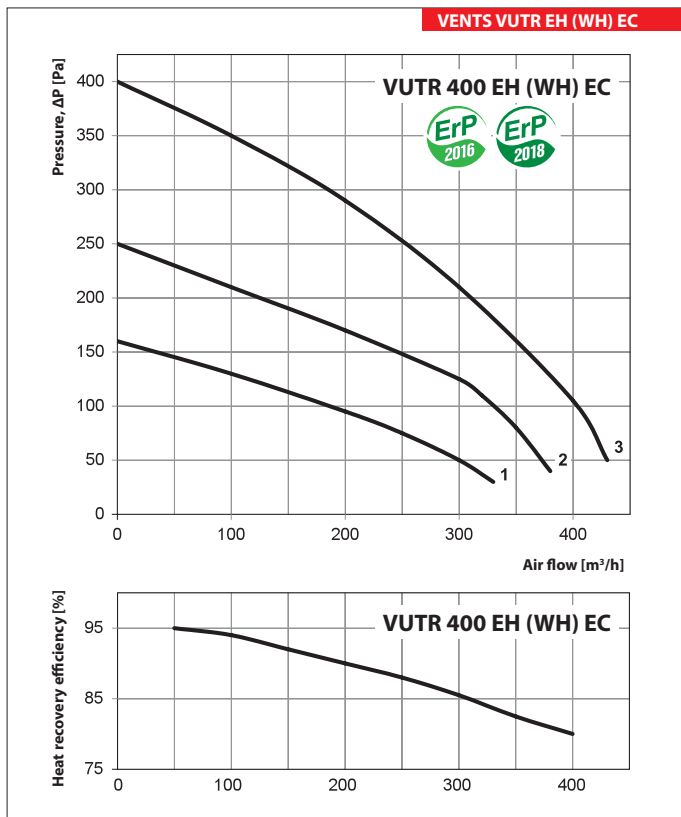

Technical data

	VUTR 1200 EH EC	VUTR 1200 WH EC	VUTR 1500 EH EC	VUTR 1500 WH EC	VUTR 2000 EH EC	VUTR 2000 WH EC
Voltage [V]	3~400	1~230	3~400	1~230	3~400	1~230
Maximum fan power [W]	416		444		896	
Electric heater power [kW]	6	-	9	-	12	-
Total unit power [W]	6570	570	9750	750	13070	1070
Total unit current [A]	9.5	2.5	14.1	3.2	22.4	5
Maximum air flow [m³/h]	1200		1500		2250	
RPM	up to 1930		up to 2000		up to 3000	
Sound pressure level at 3 m distance [dBA]	60		62		64	
Transported air temperature [°C]	-25...+40					
Casing material	Aluzinc					
Insulation	20 mm mineral wool			25 mm mineral wool		
Extract filter	G4					
Supply filter	G4					
Connected air duct diameter [mm]	Ø315		Ø315		500x300	
Mass [kg]	165		175		198	
Heat recovery efficiency [%]	73-95		72-95		68-93	
Heat exchanger type	rotary					
Heat exchanger material	aluminium					

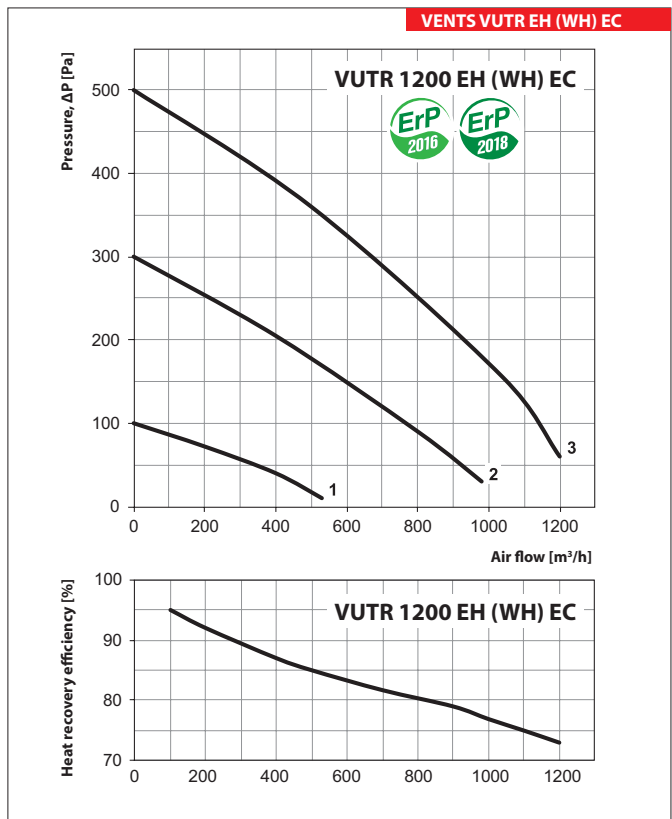
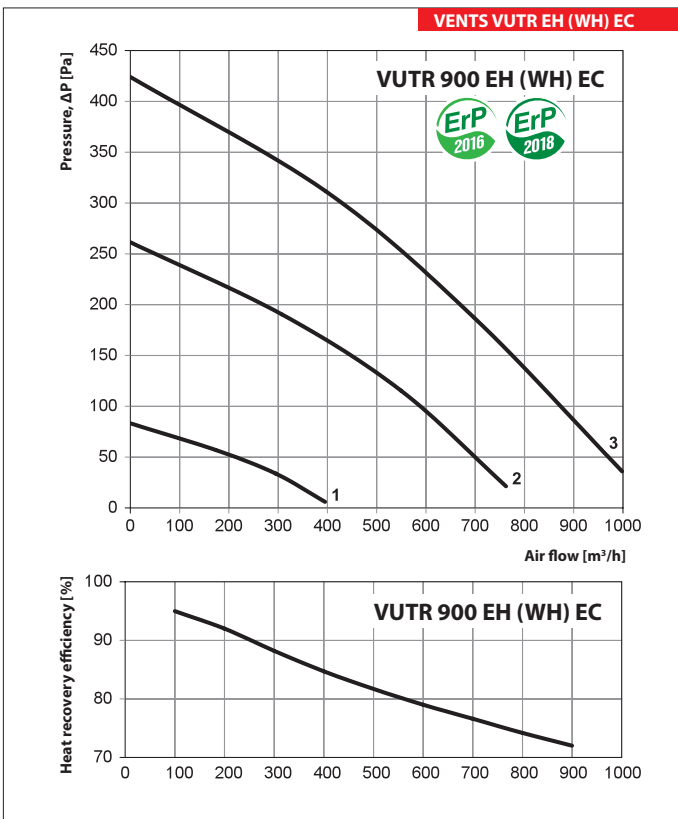

VENTS VUTR EH (WH) EC

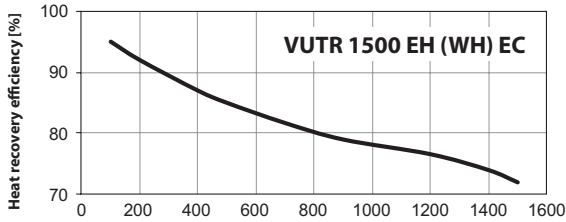
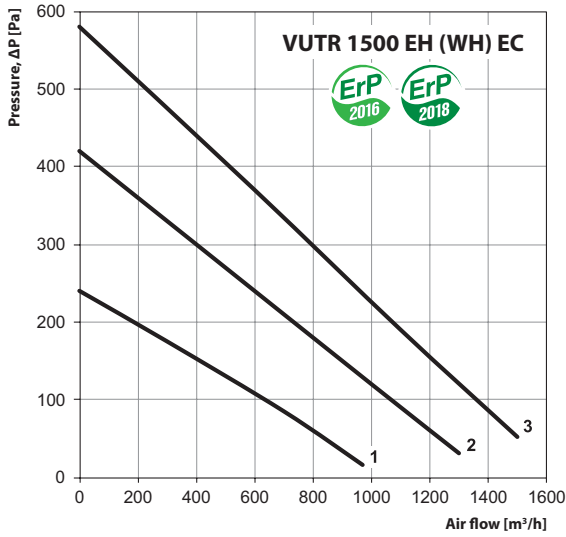

VENTS VUTR EH (WH) EC

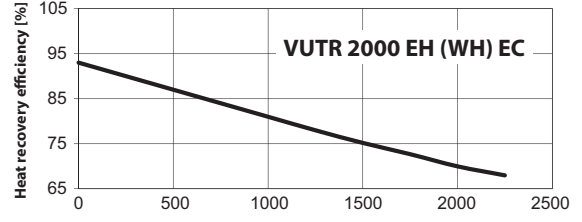
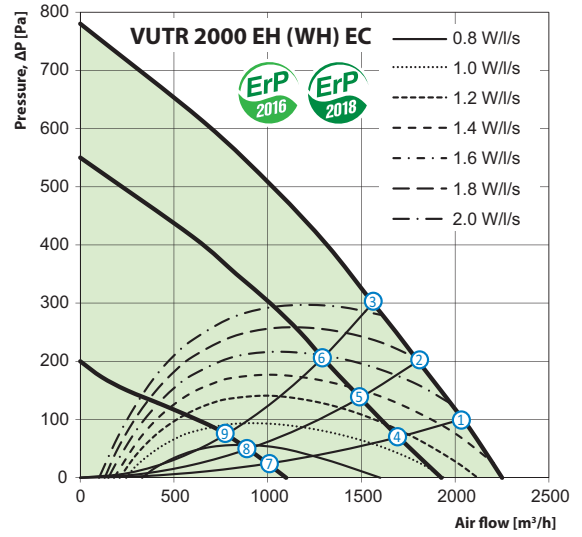

Water heater parameters calculation

VENTS VUTR WH EC

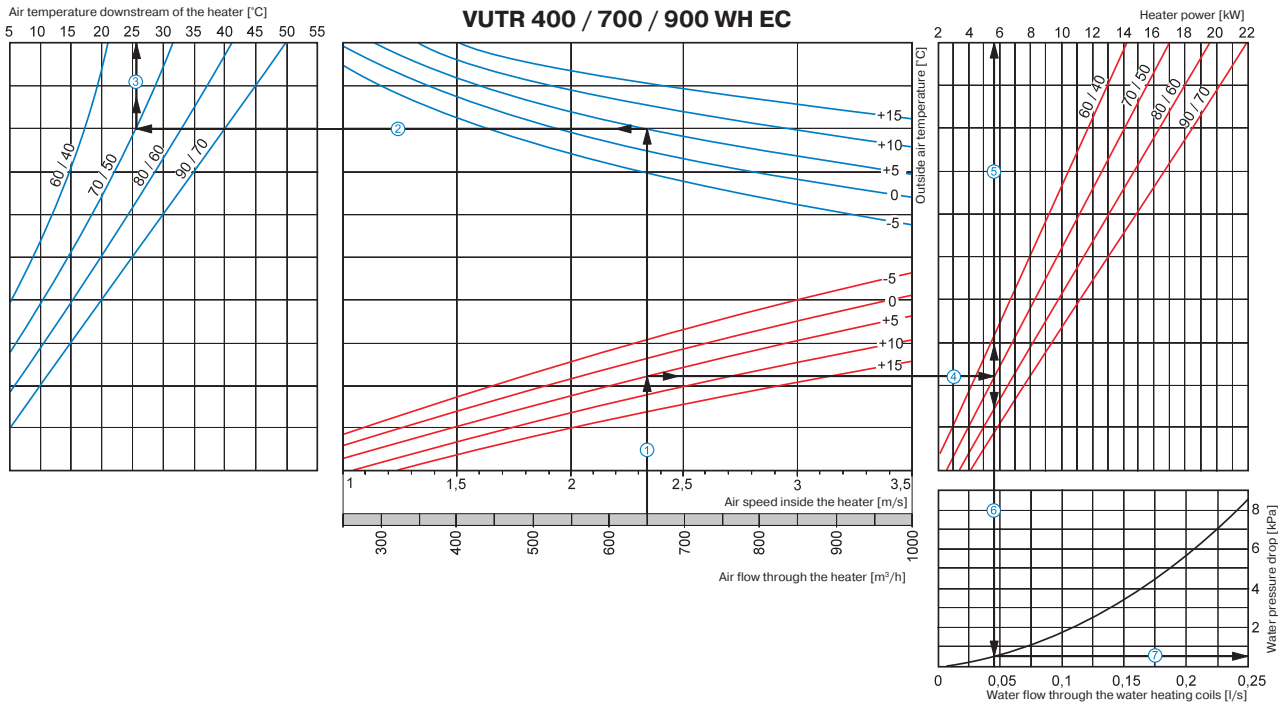

Water heater parameters calculation example

The air flow is 650 m³/h and the air speed in the heater is 2.35 m/s ①.

- To calculate the maximum air temperature find the intersection point of the air flow line ① with the rated winter temperature shown in blue line (e.g., +5 °C) and draw the line ② to the left until it crosses the water in/out temperature curve (e.g. 70/50). From this point draw a vertical line to the supply air temperature downstream of the heater (+26 °C) ③.
- To calculate the heater power find the intersection point of the air flow ① with the rated winter temperature shown in red line (e.g., +5 °C) and draw the line ④ to the right until it crosses the water in/out temperature curve (e.g. 70/50). From this point draw a vertical line to the heater power axis (5.8 kW) ⑤.
- To calculate the required water flow in the heater prolong this line ⑥ downwards to the water flow axis (0,04 l/s).
- To calculate the water pressure drop in the heater find the intersection point of the line ⑥ with the pressure loss curve and prolong the line ⑦ to the right on the water pressure drop axis (0.5 kPa).

Water heater parameters calculation

VENTS VUTR WH EC

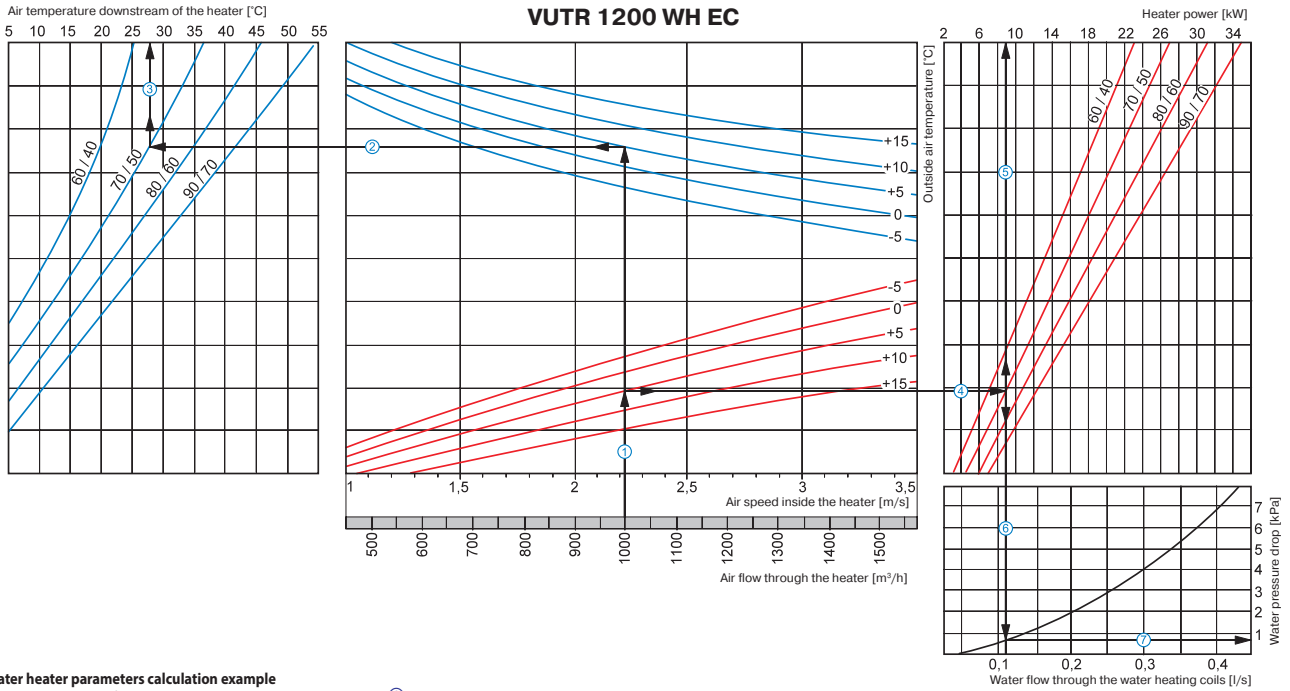

Water heater parameters calculation example

The air flow is 1000 m³/h and the air speed in the heater is 2.22 m/s ①.

- To calculate the maximum air temperature find the intersection point of the air flow line ① with the rated winter temperature shown in blue line (e.g., +5 °C) and draw the line ② to the left until it crosses the water in/out temperature curve (e.g. 70/50). From this point draw a vertical line to the supply air temperature downstream of the heater (28 °C) ③.
- To calculate the heater power find the intersection point of the air flow ① with the rated winter temperature shown in red line (e.g., +5 °C) and draw the line ④ to the right until it crosses the water in/out temperature curve (e.g. 70/50). From this point draw a vertical line to the heater power axis (9.0 kW) ⑤.
- To calculate the required water flow in the heater prolong this line ⑤ downwards to the water flow axis (0.11 l/s).
- To calculate the water pressure drop in the heater find the intersection point of the line ⑥ with the pressure loss curve and prolong the line ⑦ to the right on the water pressure drop axis (0.8 kPa).

VENTS VUTR WH EC

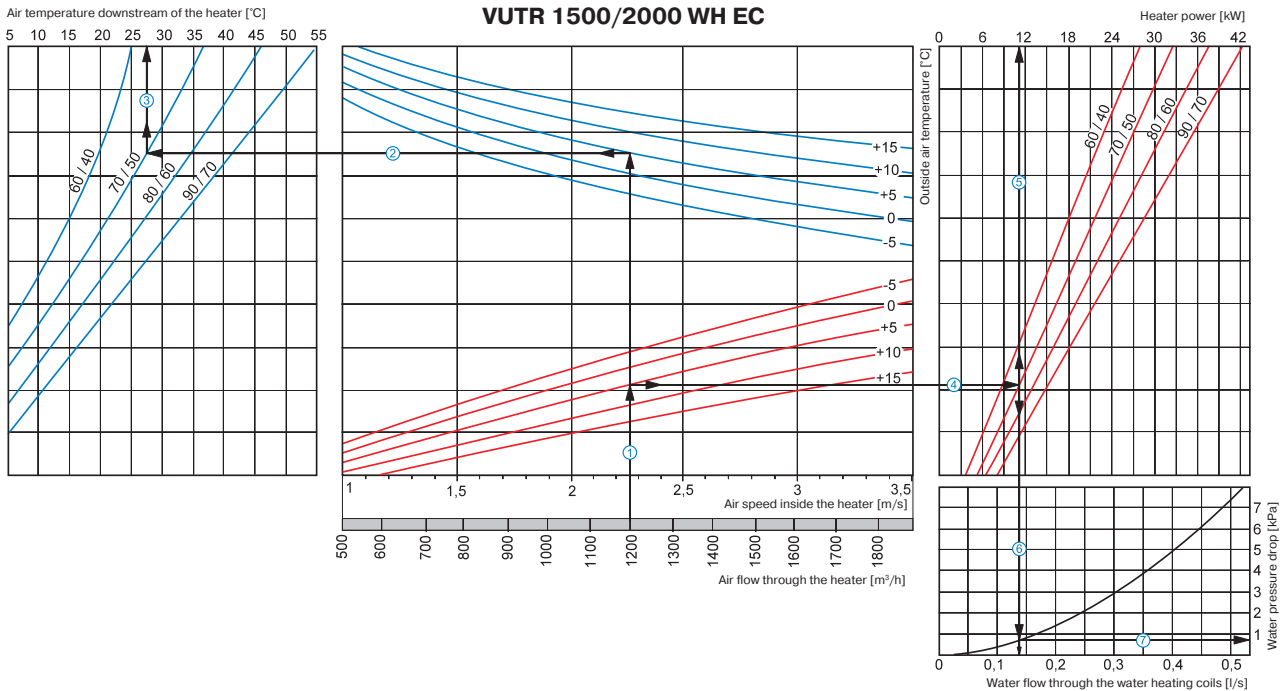

Water heater parameters calculation example

The air flow is 1200 m³/h and the air speed in the heater is 2.25 m/s ①.

- To calculate the maximum air temperature find the intersection point of the air flow line ① with the rated winter temperature shown in blue line (e.g., +5 °C) and draw the line ② to the left until it crosses the water in/out temperature curve (e.g. 70/50). From this point draw a vertical line to the supply air temperature downstream of the heater (27 °C) ③.
- To calculate the heater power find the intersection point of the air flow ① with the rated winter temperature shown in red line (e.g., +5 °C) and draw the line ④ to the right until it crosses the water in/out temperature curve (e.g. 70/50). From this point draw a vertical line to the heater power axis (11.0 kW) ⑤.
- To calculate the required water flow in the heater prolong this line ⑤ downwards to the water flow axis (0.13 l/s).
- To calculate the water pressure drop in the heater find the intersection point of the line ⑥ with the pressure loss curve and prolong the line ⑦ to the right on the water pressure drop axis (0.8 kPa).

AIR HANDLING UNITS WITH HEAT RECOVERY

Accessories for air handling units

Model	G4 supply pocket filter	G4 extract panel filter	Module Modbus-RS485	Outdoor air quality sensor	Outdoor CO ₂ sensor	Outdoor humidity sensor	Outdoor humidity sensor	Indoor humidity sensor (0-10 V)	Mixing unit	Back valves	Air damper	Electric actuator
VUTR 400 EH EC	SFK	SF							-			CM230
VUTR 400 WH EC	393x235x27 G4	600x324x48 G4							USVK 3/4-4	KOM 160	KRV 160	TF230
VUTR 700 EH EC									-			CM230
VUTR 700 WH EC	SFK	SF							USVK 3/4-4			TF230
VUTR 900 EH EC	700x333x27 G4	700x332x48 G4							-	KOM 250	KRV 250	CM230
VUTR 900 WH EC									USVK 3/4-4			TF230
VUTR 1200 EH EC	SFK	SF	PCOS004850	DPWQ 30600	DRWQ 40200	DPWC 11200	HR-S	HV-2	-			CM230
VUTR 1200 WH EC	700x423x27 G4	700x410x48 G4							USVK 3/4-4			TF230
VUTR 1500 EH EC									-	KOM 315	KRV 315	CM230
VUTR 1500 WH EC	SFK	SF							USVK 1-6			TF230
VUTR 2000 EH EC	800x477x27 G4	800x477x47 G4							-			CM230
VUTR 2000 WH EC									USVK 1-6	KOM1 500x300	KR 500x300	TF230

Application options

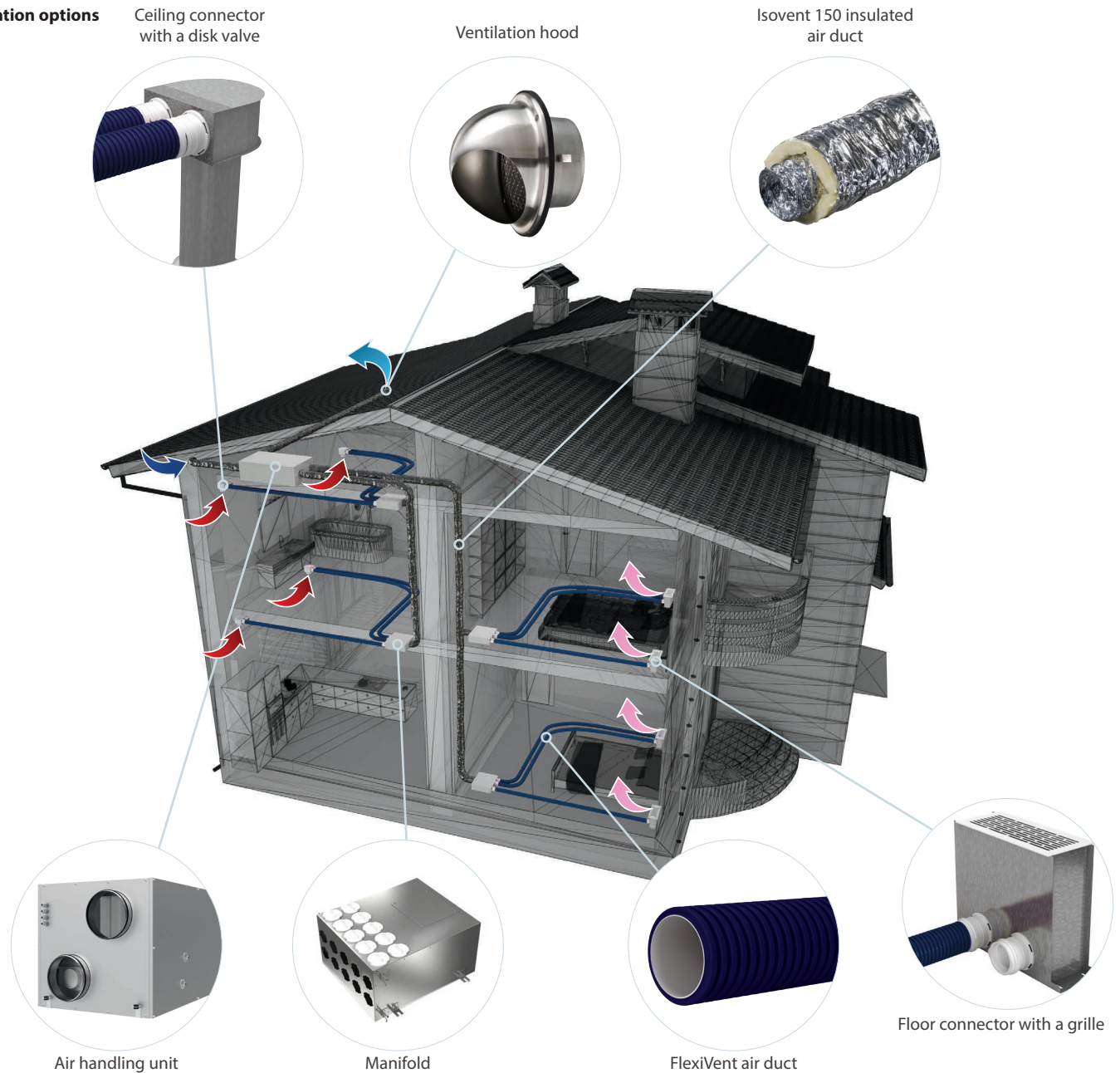

Series
VENTS VUTR 200 V6EK EC



Air handling units in a heat- and sound-insulated casing. Air flow is up to **270 m³/h**. Heat recovery efficiency is up to **92 %**.

Description

The VUTR V/VE EC air handling units are the fully-featured ventilation units that ensure air filtration, fresh air supply and stale air extraction.

The units are used in ventilation systems installed in multipurpose premises requiring reasonable energy saving solutions and controllable ventilation systems. The units are equipped with an in-built kitchen hood.

Modifications

VUTR 200 V6K EC – models without an electric heater.

VUTR 200 V6EK EC – models are equipped with an electric heater.

Casing

Made of galvanized steel, internally filled with a mineral wool heat- and sound-insulating layer.

Kitchen hood

All units are equipped with an in-built kitchen hood.



Filter

Two integrated G4 and F7 filters ensure sufficient intake air purification. Extract air is cleaned by the integrated G4 filter.

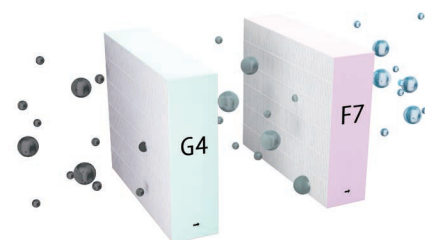

Motor

The units are equipped with high-efficient EC motors with an external rotor and a centrifugal impeller.

Rotary heat exchanger

Units equipped with a rotary heat exchanger. As compared to plate heat exchangers, the rotary heat exchangers are distinguished with no condensate forming, ability to maintain comfortable air humidity and extremely low freezing danger.

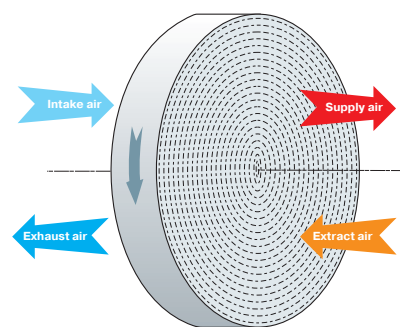

Rotary heat exchanger operation principle

Heater

The **VUTR 200 V6EK EC** units are equipped with an electric heater. The heaters are equipped with protecting devices to ensure safe and reliable operation of the unit.

Automation

The **VUTR 200 V6K(V6EK) EC 21** units are equipped with an integrated control system. An A21 controller allows integrating the unit into the **Smart Home system** or **BMS (Building Management Systems)**.

To control the unit using a mobile application via Wi-Fi, you need to download the VENTS Home mobile application.



Mounting

The air handling unit can be wall-mounted or integrated into a modular kitchen.

It is possible to attach a decorative kitchen door to the front panel of the unit.

Overall dimensions

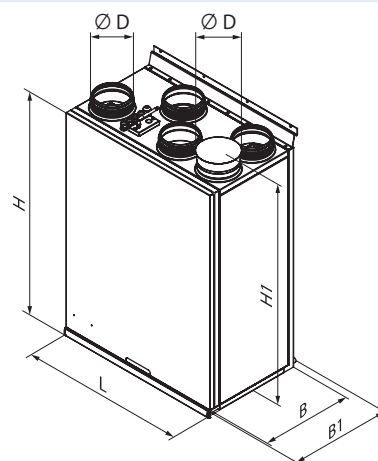

Model	Dimensions [mm]					
	Ø D	B	B1	H	H1	L
VUTR 200 V6K(V6EK) EC	125	348	371	791	865	598



Designation key









Series	Heat exchanger type	Rated air flow [m ³ /h]	Mounting type	Casing design	Additional equipment	Motor type	Control panel
VENTS VUT	R: rotary	200	V: vertical	6: casing with a thin kitchen hood	E: with an electric heater K: kitchen hood	EC: synchronous motor with electronic control	A21

Control and automation

Functions	A21
Wi-Fi control via mobile application	+
Control via a wired remote control panel	A22 (option) 
Control via a wireless remote control panel	A22 Wi-Fi (option) 
Control via a wired remote LCD control panel	A25 (option) 
BMS	RS-485 WI-FI Ethernet MODBUS (RTU, TCP)
Service Vents Cloud Server	+
Speed selection	+
Filter replacement indication	according to hour meter readings
Alarm indication	full alarm description in the mobile application
Weekly schedule operation	+
Timer	+
Boost mode	+
Fireplace mode	+
Reheater connection	integrated in E models, external reheater cannot be connected
Cooler connection	option
Kitchen hood connection	option
Minimum supply air temperature control	+
Humidity control	option
CO ₂ control	option
VOC control	option
Fire alarm sensor connection	option

*Option. The functionality is available when you purchase the appropriate accessory.

Accessories

Model	G4 panel filter	F7 panel filter	LCD control panel	Control panel	Control panel with Wi-Fi	VOC sensor 0-10 V	CO ₂ sensor 0-10 V	Humidity sensor 0-10 V	Humidity sensor NO
VUTR 200 V6K EC A21									
VUTR 200 V6EK EC A21	SF 284x103x60 G4	SF 284x103x60 F7	A25	A22	A22 Wi-Fi	DPWQ 30600	DPWQ 40200	DPWC 11200	HR-S

Model	Humidity sensor	External CO ₂ sensor with indication	External CO ₂ sensor	Silencers		Back valves	Air dampers	Clamps	Electric actuator	
VUTR 200 V6K EC A21										
VUTR 200 V6EK EC A21	HV-2	CO2-1	CO2-2	SR 125	SRF 125	KOM 125	KRV 125	C 125	LF230	TF230

Technical data

		VUTR 200 V6K EC	VUTR 200 V6EK EC
Unit voltage [V/50 (60) Hz]		1~230	
Max. unit power without electric heater [W]		118	
Max. power of electric heater [W]		-	700
Max. unit power [W]		118	818
Max. unit current without electric heater [A]		1.0	
Max. unit current of electric heater [A]		-	3.0
Max. unit current [A]		1.0	4.0
Maximum air flow [m ³ /h]		270	
RPM [min ⁻¹]		1800	
Sound pressure level at 3 m distance [dBA]		28	
Transported air temperature [°C]		-25...+40	
Casing material		painted steel	
Insulation		20 mm mineral wool	
Filter	Extract	G4	
	Supply	G4, F7	
Connected air duct diameter [mm]		125	
Weight [kg]		47	48
Heat recovery efficiency		from 75 up to 92	
Heat exchanger type*		rotary	
Heat exchanger material		aluminium	
SEC class		A	

*Heat recovery efficiency is specified in compliance with EN 13141-7

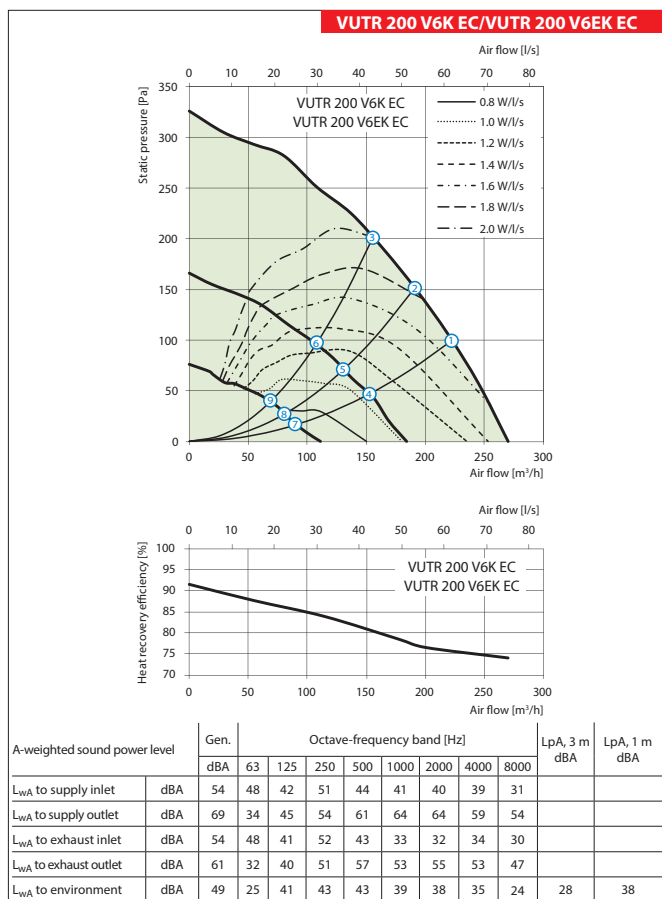

Point	Total unit power [W]	Sound pressure level at 3 m (1 m) distance [dBA]
	VUTR 200 V6K EC VUTR 200 V6EK EC	VUTR 200 V6K EC VUTR 200 V6EK EC
1	103	28(38)
2	98	28(38)
3	85	29(39)
4	43	21(31)
5	40	21(31)
6	37	20(30)
7	18	19(29)
8	17	19(29)
9	16	17(27)

Calculation of air temperature downstream of the heat exchanger:

$$t = t_{\text{outd}} + k_{\text{hr}} * (t_{\text{extr}} - t_{\text{outd}}) / 100,$$

where

t_{outd} : outdoor air temperature [°C]

t_{extr} : extract air temperature [°C]

k_{hr} : heat exchanger efficiency (according to the diagram) [%]

Application options

Ceiling connector with a disk valve



Ventilation hood



Isovent 150 insulated air duct

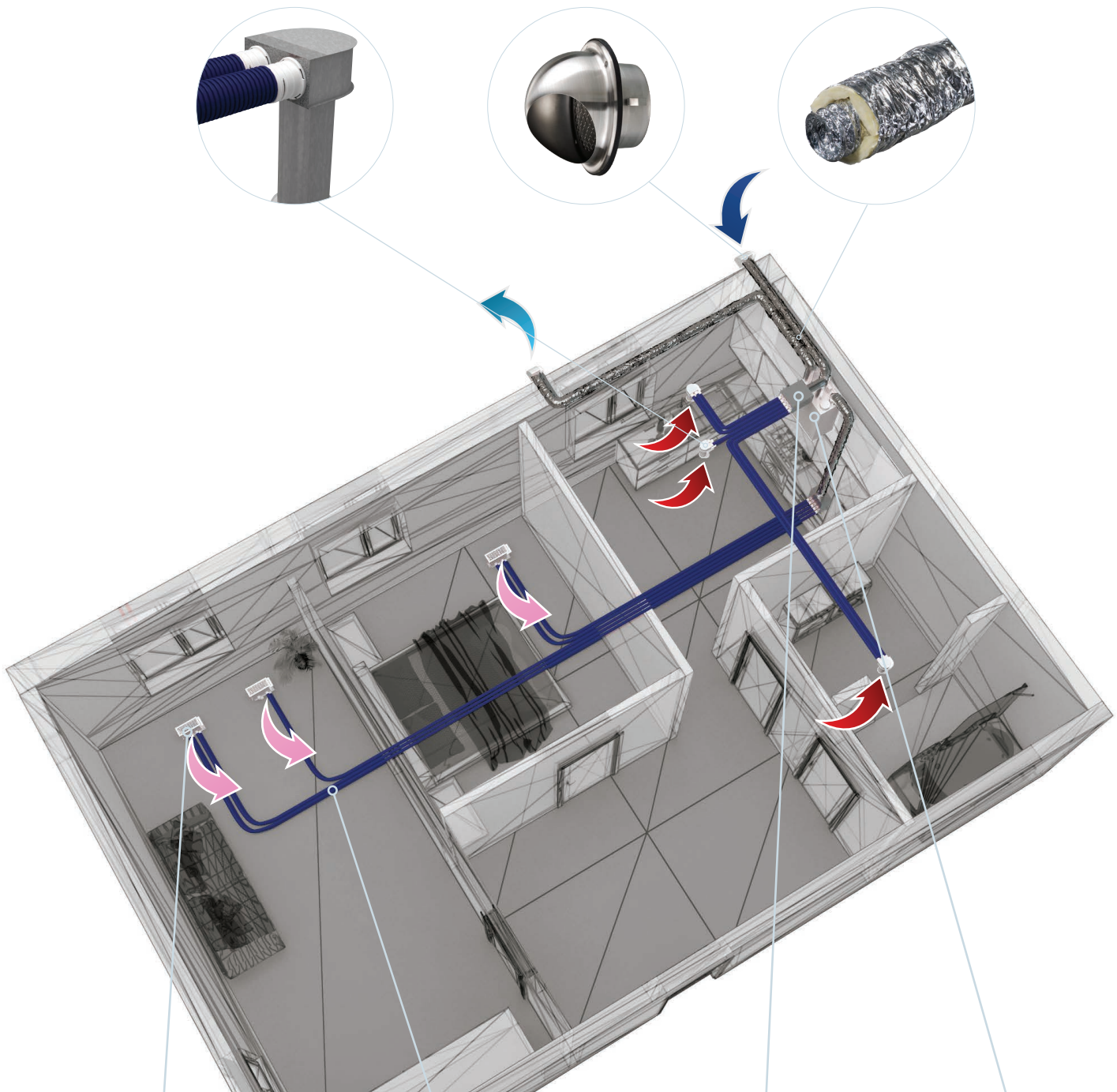

Floor connector with a grille

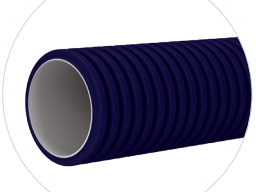

FlexiVent air duct

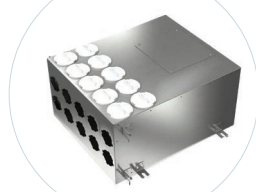

Manifold



Air handling unit

Series
VENTS VPA



A16 control panel

Supply units with the air flow up to **1520 m³/h** in the compact sound- and heat-insulated casing with electric heater.

Description

The fan unit provides filtration, heating and supply of fresh air to premises with the air flow from 200 up to 1500 m³/h.

Casing

The casing is made of aluzinc with internal heat- and sound-insulating 25 mm layer of mineral wool.

Filter

Integrated panel G4 filter ensures sufficient supply air purification.

Heater

Electric heating battery is designed for supply air heating during winter and off-season time.

Fan

Centrifugal fan with backward curved blades and built-in overheating thermostat with automatic restart. The motor ball bearings are maintenance-free and are designed for at least 40 000 hours service life.

Control and automation

Integrated control and automation system for air flow control and setting supply air temperature. The unit may be controlled from the external control panel fixed on 10 m wire delivered as a standard.

Control and protection functions

- ▶ switching the unit on/off;
- ▶ maintaining supply air temperature set from the control panel by means of triac heating capacity regulation;
- ▶ fan speed control by means of the control panel (3 speed modes);
- ▶ working-out of the required patterns during the unit switching on and off;
- ▶ the unit daily or week timer operation;
- ▶ active overheating protection of heating elements;
- ▶ disabling electric air heating battery operation when the motor is not running;
- ▶ electric heater overheating protection by means of two thermostats;
- ▶ filter clogging control through the differential pressure sensor;
- ▶ actuating the air damper;
- ▶ relay input from an external sensor (humidistat, CO₂ sensor, motion sensor) to switch the fan to maximum speed;
- ▶ input for alarm fire fighting signal.

Mounting

Air supply unit can be mounted on the floor, attached to a ceiling with a seat angle with anti-vibration mounts or attached to a wall by means of the brackets. The unit can be mounted either in service spaces (balcony, storage room, underground floor, roof space etc.) or in the main space by placing the unit above the suspended ceiling or in the pocket. The unit can be mounted in any position except for the vertical one with vertical air downstream because tubular heating elements are not allowed under the fan. Free access to the unit shall be provided for maintenance and filter cleaning. The service panel is placed on the top. The control block is on the right.

Designation key

Series		Air duct diameter	Electric heater power [kW]	Phase	Integrated control system
VENTS VPA	1: high-powered motor	100; 125; 150; 200; 250; 315	1.8; 2.4; 3.4; 3.6; 5.1; 6; 9	1: single phase 3: three phase	LCD: integrated automation with A16 control panel

Accessories



Technical data

	VPA 100- 1,8-1	VPA 125- 2,4-1	VPA 150- 2,4-1	VPA 150- 3,4-1	VPA 150- 5,1-3	VPA 150- 6,0-3	VPA 200- 3,4-1	VPA 200- 5,1-3	VPA 200- 6,0-3	
Voltage [V/50 Hz]	1~230		1~230		3~400		1~230		3~400	
Maximum fan power [W]	73	75	98			193				
Fan current [A]	0.32	0.33	0.43			0.84				
Electric heater power [kW]	1.8	2.4	2.4	3.4	5.1	6.0	3.4	5.1	6.0	
Electric heater current [A]	7.8	10.4	10.4	14.8	7.4	8.7	14.8	7.4	8.7	
Number of electrical heating elements	3	3	2	2	3	3	2	3	3	
Total unit power [kW]	1.873	2.475	2.498	3.498	5.198	6.098	3.593	5.293	6.193	
Total unit current [A]	8.12	10.73	10.83	15.23	7.83	9.13	15.64	8.24	9.54	
Air flow [m³/h]	190	285	425			810				
RPM [min ⁻¹]	2830	2800	2705			2780				
Noise level at 3m [dBA]	27	28	29			30				
Transported air temperature [°C]	-25...+40		-25...+40			-25...+40				
Casing material	aluzinc			aluzinc			aluzinc			
Insulation	25 mm mineral wool		25 mm mineral wool			25 mm mineral wool				
Filter	G4		G4			G4				
Connected air duct size [mm]	100	125	150			200				
Mass [kg]	50		50			52				

Technical data

	VPA 250-3,6-3	VPA 250-6,0-3	VPA 250-9,0-3	VPA 315-6,0-3	VPA 315-9,0-3	VPA-1 315-6,0-3	VPA-1 315-9,0-3
Voltage [V/50 Hz]	3~400		3~400				
Maximum fan power [W]	194		171			296	
Fan current [A]	0.85		0.77			1.34	
Electric heater power [kW]	3.6	6.0	9.0	6.0	9.0	6.0	9.0
Electric heater current [A]	5.3	8.7	13.0	8.7	13.0	8.7	13.0
Number of electrical heating elements	3	3	3	3	3	3	3
Total unit power [kW]	3.794	6.194	9.194	6.171	9.171	6.296	9.296
Total unit current [A]	6.15	9.55	13.85	9.47	13.77	10.04	14.34
Air flow [m³/h]	990		1190			1520	
RPM [min ⁻¹]	2790		2600			2720	
Noise level at 3m [dBA]	30		30			30	
Transported air temperature [°C]	-25...+40		-25...+40			-25...+40	
Casing material	aluzinc		aluzinc				
Insulation	25 mm mineral wool		25 mm mineral wool				
Filter	G4		G4				
Connected air duct size [mm]	250		315				
Mass [kg]	52		62				

Unit overall dimensions

Type	Dimensions [mm]					
	∅D	B	B1	H	L	L1
VPA 100	99	382	421.5	408	800	647
VPA 125	124	382	421.5	408	800	647
VPA 150	149	455	496,5	438	800	647
VPA 200	199	487	526,5	513	835	684
VPA 250	249	487	526,5	513	835	684
VPA 315	314	527	566,5	548	900	750

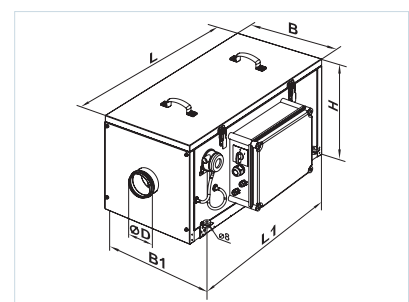

SUPPLY UNITS

VENTS VPA

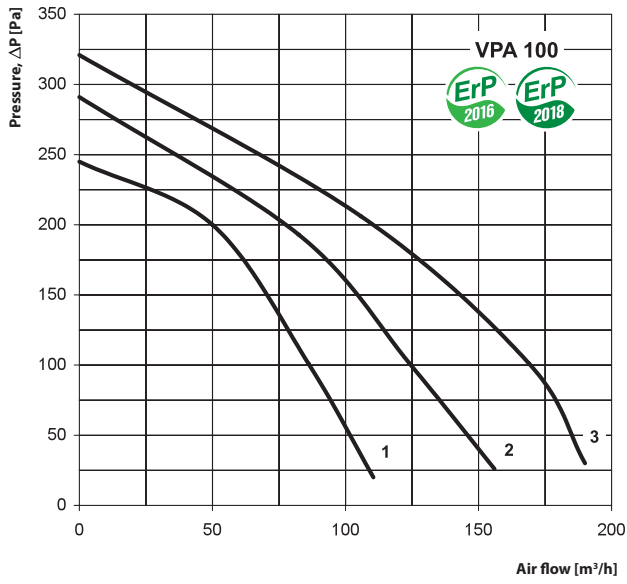

Sound-power level	Hz	Octave-frequency band [Hz]								
		Gen	63	125	250	500	1000	2000	4000	8000
L_{WA} to inlet	dBA	50	30	47	47	35	40	37	28	16
L_{WA} to outlet	dBA	58	39	50	56	49	45	42	33	23
L_{WA} to environment	dBA	31	5	21	28	24	19	13	4	0

VENTS VPA

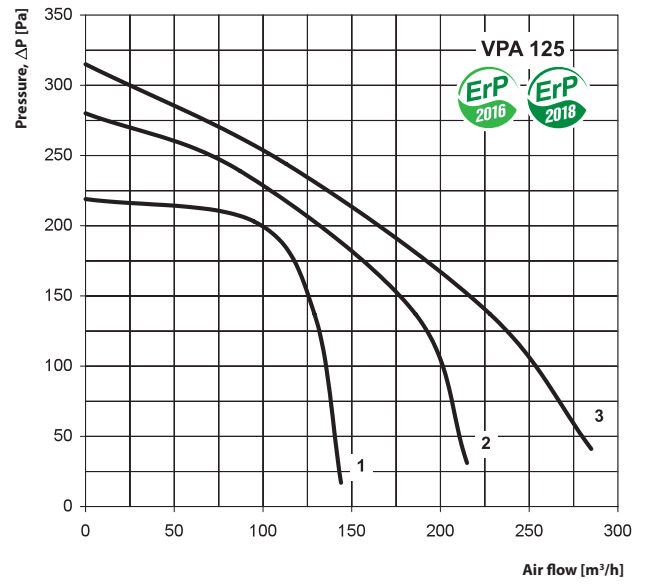

Sound-power level	Hz	Octave-frequency band [Hz]								
		Gen	63	125	250	500	1000	2000	4000	8000
L_{WA} to inlet	dBA	52	31	48	48	36	41	40	32	18
L_{WA} to outlet	dBA	62	40	53	56	52	47	47	37	23
L_{WA} to environment	dBA	33	9	24	33	26	17	16	3	4

VENTS VPA

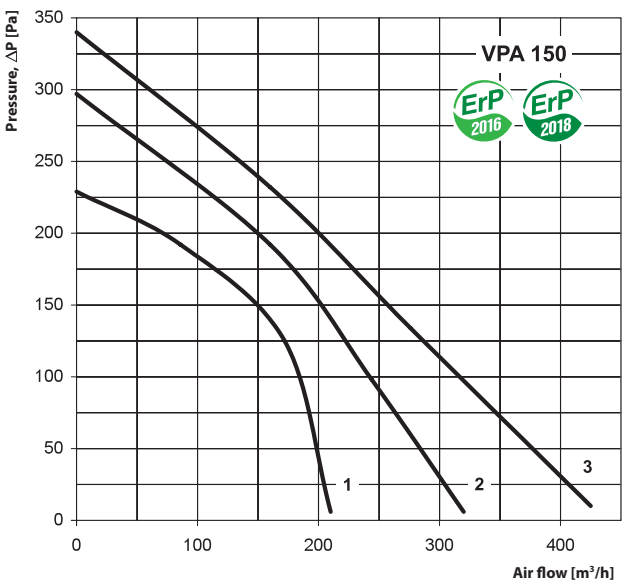

Sound-power level	Hz	Octave-frequency band [Hz]								
		Gen	63	125	250	500	1000	2000	4000	8000
L_{WA} to inlet	dBA	65	37	53	63	50	53	53	45	30
L_{WA} to outlet	dBA	63	22	43	53	52	57	57	46	36
L_{WA} to environment	dBA	41	14	34	39	19	27	19	7	0

VENTS VPA

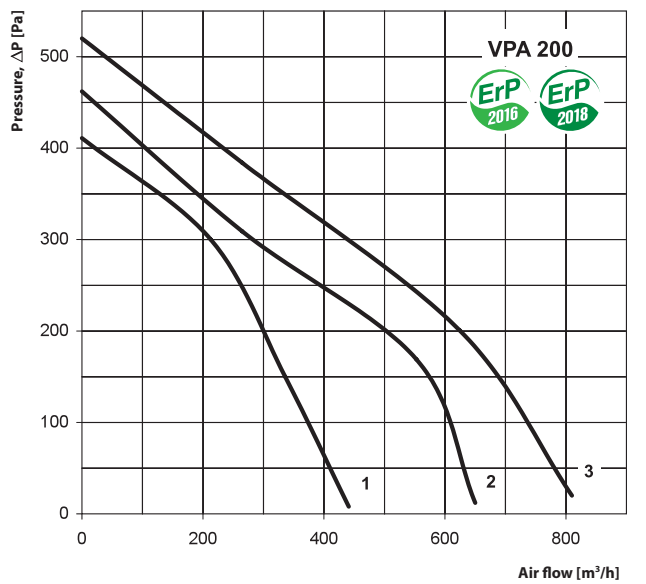

Sound-power level	Hz	Octave-frequency band [Hz]								
		Gen	63	125	250	500	1000	2000	4000	8000
L_{WA} to inlet	dBA	65	41	58	59	56	60	62	56	41
L_{WA} to outlet	dBA	71	46	57	63	64	66	66	58	45
L_{WA} to environment	dBA	46	15	31	43	40	34	30	22	8

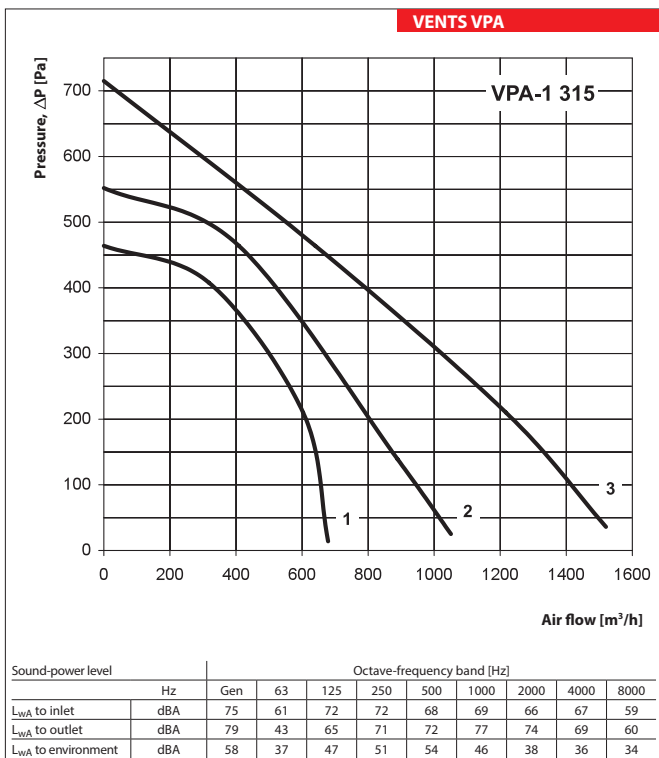
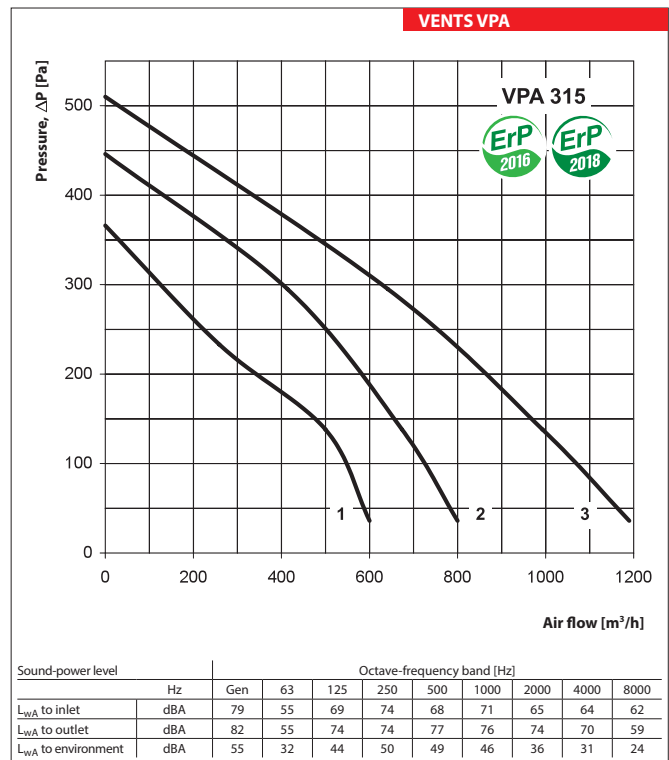
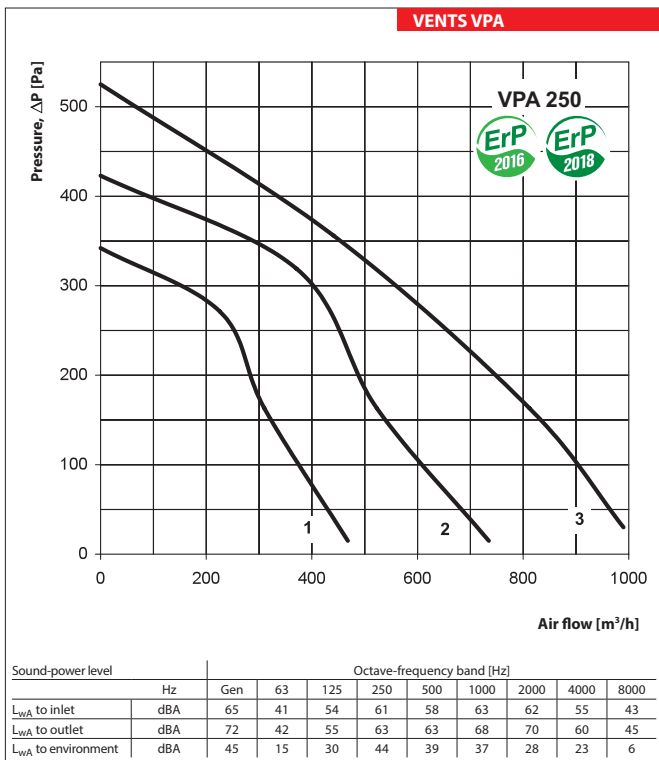

Accessories to supply units

Type	Replaceable filter	Filter type
VPA 100-1,8-1	SF 335x322x70 G4	panel filter
VPA 125-2,4-1		
VPA 150-2,4-1	SF 397x364x70 G4	panel filter
VPA 150-3,4-1		
VPA 150-5,1-3		
VPA 150-6,0-3		
VPA 200-3,4-1	SF 439x428x70 G4	panel filter
VPA 200-5,1-3		
VPA 200-6,0-3		
VPA 250-3,6-3		
VPA 250-6,0-3	SF 475x470x70 G4	panel filter
VPA 250-9,0-3		
VPA 315-6,0-3		
VPA 315-9,0-3		
VPA-1 315-6,0-3	SF 475x470x70 G4	panel filter
VPA-1 315-9,0-3		

Series
VENTS MPA...E



A16 control panel

Supply units with the air flow up to **3500 m³/h** in the compact sound- and heat-insulated casing with electric heater

Series
VENTS MPA...W



A13 control panel

Supply units with the air flow up to **6500 m³/h** in the compact sound- and heat-insulated casing with water heater

■ **Description**

Air supply MPA unit is a complete ventilation unit for air filtration, air heating and supply to premises.

■ **Casing**

Steel casing covered with aluzinc coating internally filled with 25 mm heat- and sound-insulating layer made of mineral wool.

■ **Filter**

Integrated panel G4 filter ensures sufficient supply air purification.

■ **Heater**

Both electric heater (MPA...E models) and water/glycol heaters (MPA...W models) are used for heating of supply air in cold season. The water heaters are designed for max. operating pressure 1.0 MPa (10 bar) and max. operating temperature 95 °C of the heat medium.

■ **Fan**

Centrifugal double-inlet fan with forward curved blades and built-in overheating protection with automatic restart. The ball bearings in the electric motor are maintenance free and designed for at least 40000 hours operation.

■ **Control and automation**

Possible option:

Integrated control and automation system for three-speed (air flow) control and setting supply air temperature. The unit may be controlled from the external control panel fixed on 10 m wire delivered as a standard.

■ **MPA...E control and protection functions**

- ▶ Switching the unit on/off from the control panel.
- ▶ Setting the supply air temperature from the remote control panel and maintaining it by the triac heater control.
- ▶ Fan speed control from the control panel.
- ▶ Tracking the set operating control logic while turning the unit on and off.
- ▶ Unit operation according to daily and week schedule.▶ Overheating protection of the electric heating elements.

Designation key

Series	Rated air flow, m ³ /h	Heater type	Phase	Integrated control system
VENTS MPA	800; 1200; 1800; 2500; 3200; 3500; 5000	E: electric; W: water	1: single phase; 3: three phase	LCD: integrated automation with A16 control panel (MPA...E) or A13 (MPA...W)

Accessories

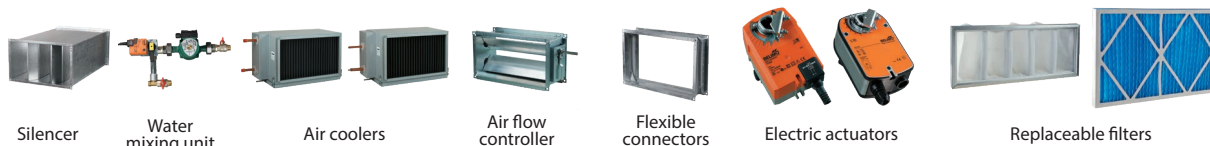

Silencer

Water mixing unit

Air coolers

Air flow controller

Flexible connectors

Electric actuators

Replaceable filters

- ▶ Disabling electric heater operation when the fans are not running.
- ▶ Electric heater overheating protection by two overheating thermostats, one thermostat activated at 60 °C with automatic reset and another thermostat activated at 90 °C with automatic reset.
- ▶ Actuating the air damper.
- ▶ Input for alarm fire fighting signal.
- ▶ Input from external humidity sensor, CO₂ sensor, etc (normally opened dry contact). On sensor's output signal the unit switches to the maximum speed.

■ MPA...W control and protection functions

- ▶ Switching the unit motor on/off.
- ▶ Three-speed fan selection.
- ▶ Maintaining set supply air temperature by means of controlling the circulating pump and heat medium regulating valve.
- ▶ Water heater freezing protection by the temperature sensor at outlet from the heating coils and the return heat medium temperature sensor.

- ▶ Control and regulation of the external circulation pump installed at the heat medium supply line to the water heater (mixing unit pump).
- ▶ Control of the compressor and condensing unit of the water cooler by the room temperature sensor (for the models equipped with a duct air cooler).
- ▶ Supply fan control and regulation.
- ▶ Filter clogging control.
- ▶ Actuating the external air damper with a return spring.
- ▶ Unit shut down at signal from the fire alarm system.

The mixing units USWK are recommended for smooth supply air temperature regulation in the units equipped with water heaters. The mixing unit USWK with three-way heat medium regulating valve and circulation pump provides smooth heating capacity regulation and minimizes the water heater freezing danger.

■ Mounting

The supply unit can be mounted on the floor, suspended to the ceiling by means of a seat angle with

a flexible connector or fixed to the wall using brackets. The unit can be installed either in such service spaces as balcony, storeroom, basement, roof space or in main premises above the suspended ceiling, in the pocket or placed directly in the room. The unit can be mounted in any position but the vertical one with air downstream because the heating elements are not allowed under the fan. Access for the unit maintenance and filter cleaning shall be provided.

Unit overall dimensions

Type	Dimensions [mm]									
	B	B1	B2	B3	H	H1	H2	L	L1	L2
MPA 800 E1	400	420	549	500	200	220	352	650	530	-
MPA 1200 E3	400	420	549	500	200	220	352	650	530	-
MPA 1800 E3	500	520	649	600	250	270	480	800	680	-
MPA 2500 E3	500	520	649	600	300	320	480	800	680	-
MPA 3200 E3	600	620	759	710	300	320	530	1000	880	440
MPA 3500 E3	600	620	759	710	350	370	530	1000	880	440

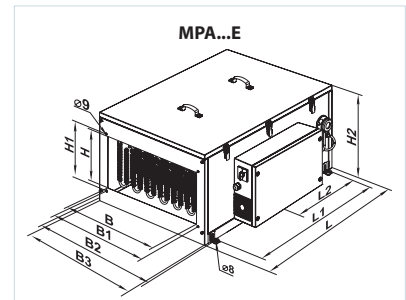

Unit overall dimensions

Type	Dimensions [mm]									
	B	B1	B2	B3	H	H1	H2	L	L1	L2
MPA 800 W	400	420	549	500	200	220	352	650	530	-
MPA 1200 W	400	420	549	500	200	220	352	650	530	-
MPA 1800 W	500	520	649	600	250	270	480	800	680	-
MPA 2500 W	500	520	649	600	300	320	480	800	680	-
MPA 3200 W	600	620	759	710	300	320	530	1000	880	440
MPA 3500 W	600	620	759	710	350	370	530	1000	880	440
MPA 5000 W	800	820	971	925	500	520	670	1299	720	360

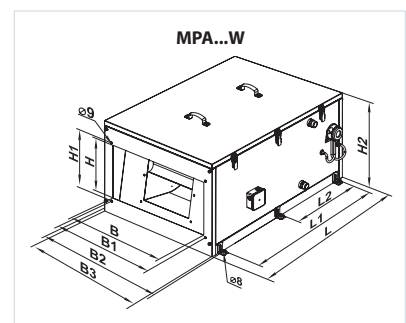

SUPPLY UNITS

Technical data

	MPA 800 E1	MPA 800 W	MPA 1200 E3*	MPA 1200 W*
Voltage [V/50 Hz]	1~230		3~400	1~230
Maximum fan power [W]	245		410	
Fan current [A]	1.08		1.8	
Electric heater power [kW]	3.3	–	9.9	–
Electric heater current [A]	14.3	–	14.3	–
Number of water (glycol) coil rows	–	4	–	4
Total unit power [kW]	3.55	0.245	9.94	0.410
Total unit current [A]	15.38	1.08	16.1	1.8
Air flow [m ³ /h]	800	750	1200	1200
RPM [min ⁻¹]	1650		1850	
Noise level at 3m [dBA]	35		38	
Transported air temperature [°C]	-25...+40	-25...+40	-25...+40	-25...+40
Casing material	aluzinc		aluzinc	
Insulation	25 mm mineral wool		25 mm mineral wool	
Filter	G4		G4	
Connected air duct size [mm]	400x200		400x200	
Mass [kg]	36.2	41.3	38.9	42.8

Technical data

	MPA 1800 E3*	MPA 1800 W*	MPA 2500 E3*	MPA 2500 W*
Voltage [V/50 Hz]	3~400	1~230	3~400	1~230
Maximum fan power [W]	490		650	
Fan current [A]	2.15		2.84	
Electric heater power [kW]	18.0	–	18.0	–
Electric heater current [A]	26.0	–	26.0	–
Number of water (glycol) coil rows	–	4	–	4
Total unit power [kW]	18.49	0.490	18.65	0.650
Total unit current [A]	28.15	2.15	28.84	2.84
Air flow [m ³ /h]	2000	1870	2500	2150
RPM [min ⁻¹]	1100		1000	
Noise level at 3m [dBA]	40		45	
Transported air temperature [°C]	-25...+40	-25...+40	-25...+40	-25...+40
Casing material	aluzinc		aluzinc	
Insulation	25 mm mineral wool		25 mm mineral wool	
Filter	G4		G4	
Connected air duct size [mm]	500x250		500x300	
Mass [kg]	61.5	62.5	62	63

Technical data

	MPA 3200 E3*	MPA 3200 W*	MPA 3500 E3*	MPA 3500 W*	MPA 5000 W*
Voltage [V/50 Hz]	3~400Y		3~400Y		3~400
Maximum fan power [W]	1270		1270		1800
Fan current [A]	2.3		2.3		4.5
Electric heater power [kW]	25.2	-	25.2	-	-
Electric heater current [A]	36.4	-	36.4	-	-
Number of water (glycol) coil rows	-	4	-	4	4
Total unit power [kW]	26.47	1.270	26.47	1.270	1.80
Total unit current [A]	38.7	2.3	38.7	2.3	4.5
Air flow [m³/h]	3200	3000	3500	3250	6500
RPM [min ⁻¹]	1200		1200		1400
Noise level at 3m [dBA]	53		53		55
Transported air temperature [°C]	-25...+40		-25...+40		-25...+40
Casing material	aluzinc		aluzinc		aluzinc
Insulation	25 mm mineral wool		25 mm mineral wool		
Filter	G4		G4		G4
Connected air duct size [mm]	600x300		600x350		800x500
Mass [kg]	69,4	73,2	69,3	73,1	136

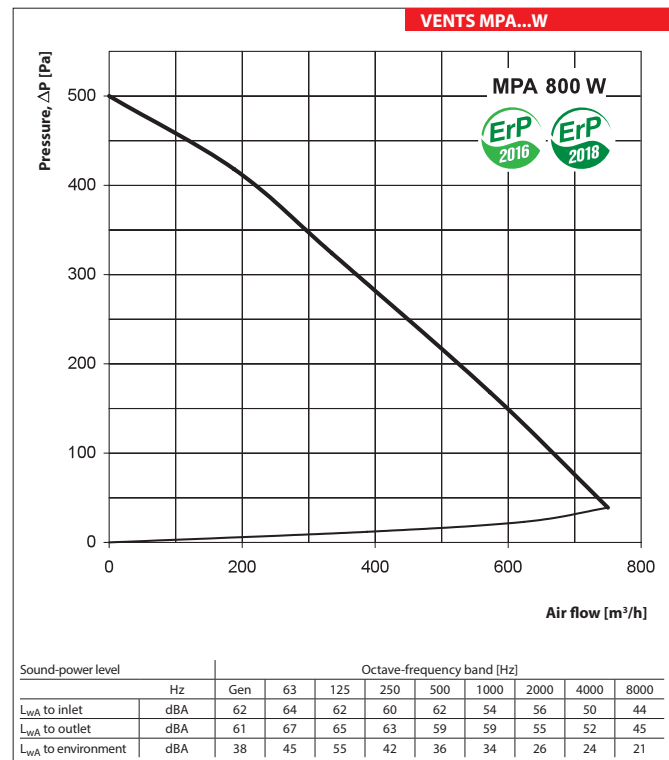
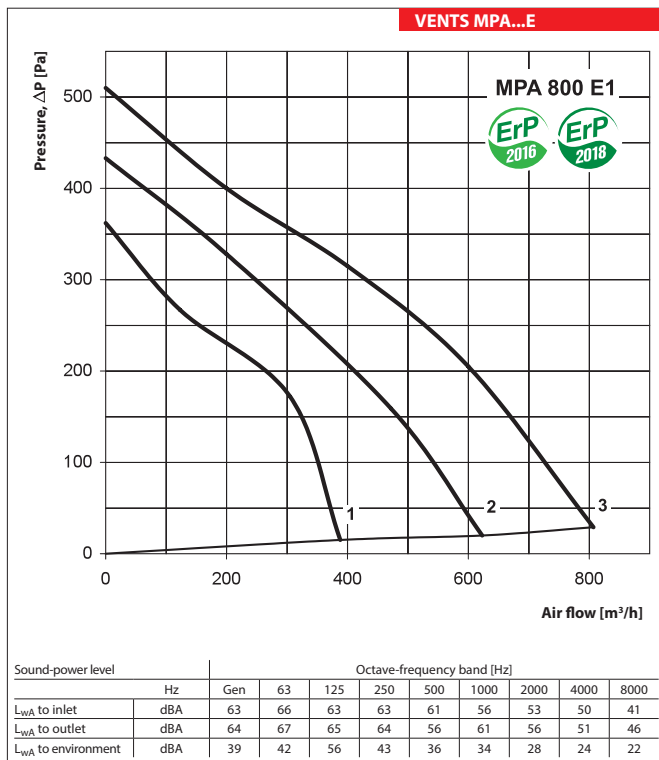

VENTS MPA...E

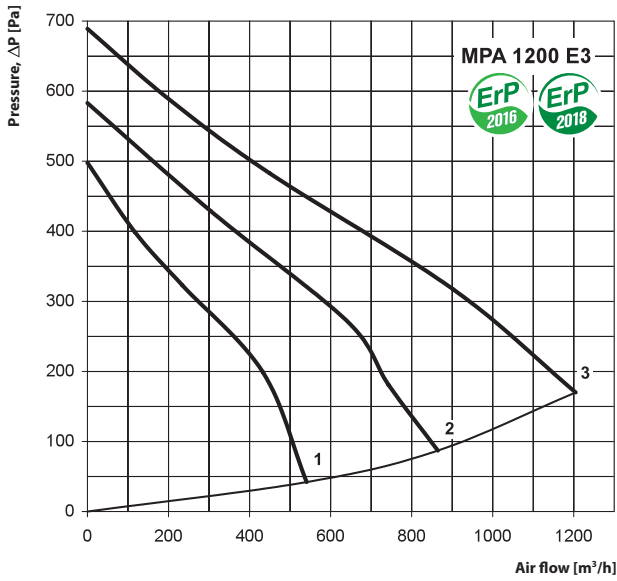

Sound-power level	Hz	Octave-frequency band [Hz]								
		Gen	63	125	250	500	1000	2000	4000	8000
L _{WA} to inlet	dBA	67	66	66	68	66	60	63	60	55
L _{WA} to outlet	dBA	72	71	70	68	68	65	60	60	57
L _{WA} to environment	dBA	45	55	54	48	52	40	37	34	35

VENTS MPA...W

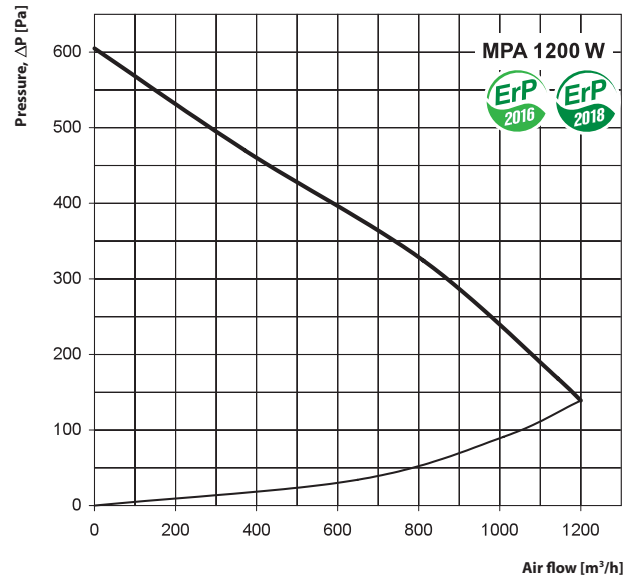

Sound-power level	Hz	Octave-frequency band [Hz]								
		Gen	63	125	250	500	1000	2000	4000	8000
L _{WA} to inlet	dBA	71	70	68	66	68	62	61	61	56
L _{WA} to outlet	dBA	71	68	69	67	64	67	62	61	57
L _{WA} to environment	dBA	48	56	54	48	53	40	39	35	33

VENTS MPA...E

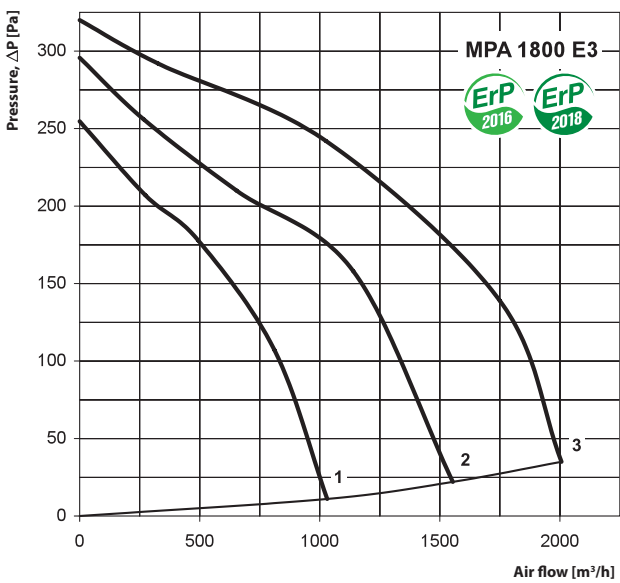

Sound-power level	Hz	Octave-frequency band [Hz]								
		Gen	63	125	250	500	1000	2000	4000	8000
L _{WA} to inlet	dBA	74	79	76	74	67	67	64	64	54
L _{WA} to outlet	dBA	75	82	78	74	68	73	66	70	67
L _{WA} to environment	dBA	52	64	62	54	48	44	40	36	34

VENTS MPA...W

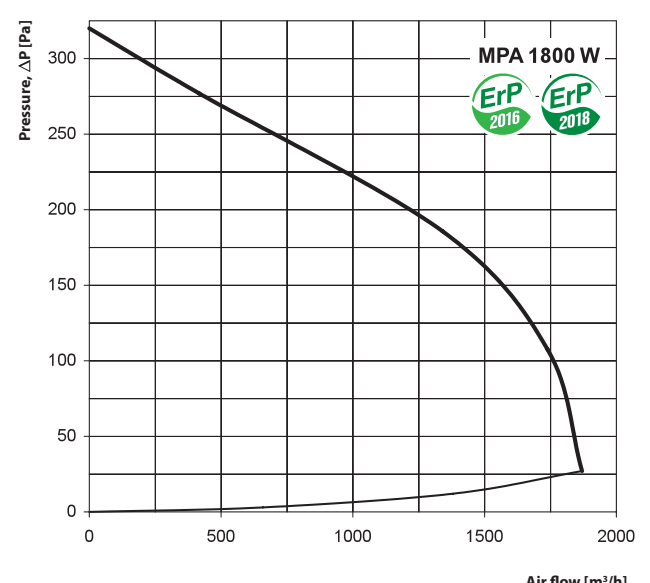

Sound-power level	Hz	Octave-frequency band [Hz]								
		Gen	63	125	250	500	1000	2000	4000	8000
L _{WA} to inlet	dBA	73	78	77	77	67	68	62	63	57
L _{WA} to outlet	dBA	75	79	78	74	68	73	66	69	66
L _{WA} to environment	dBA	51	63	61	54	47	44	40	37	33

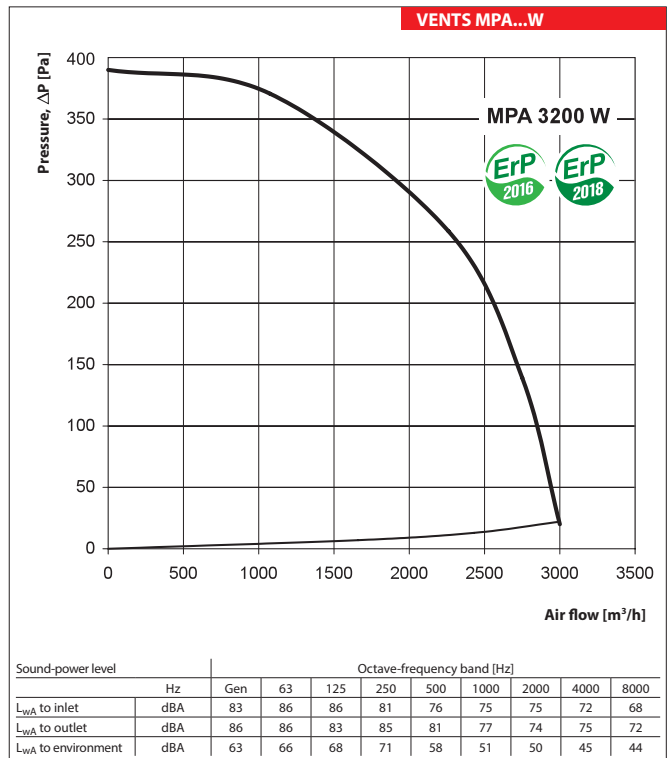
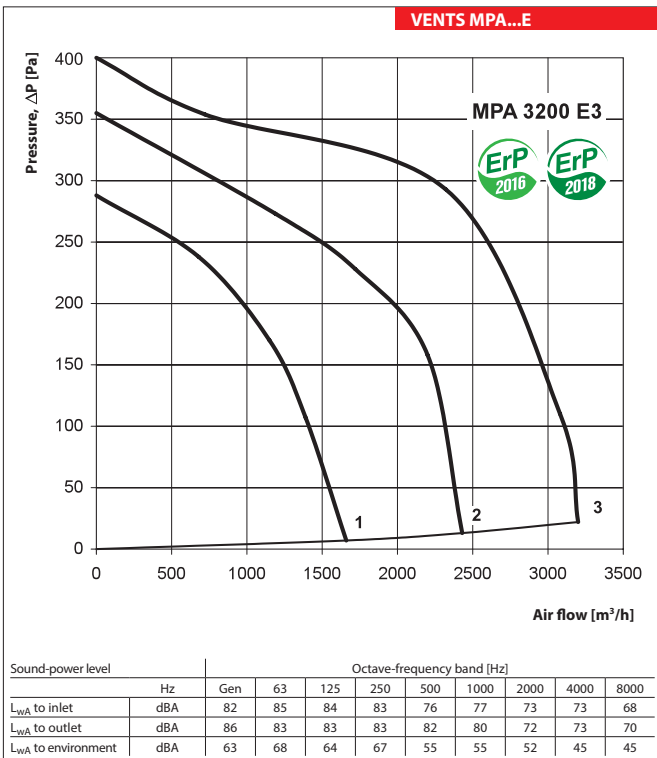
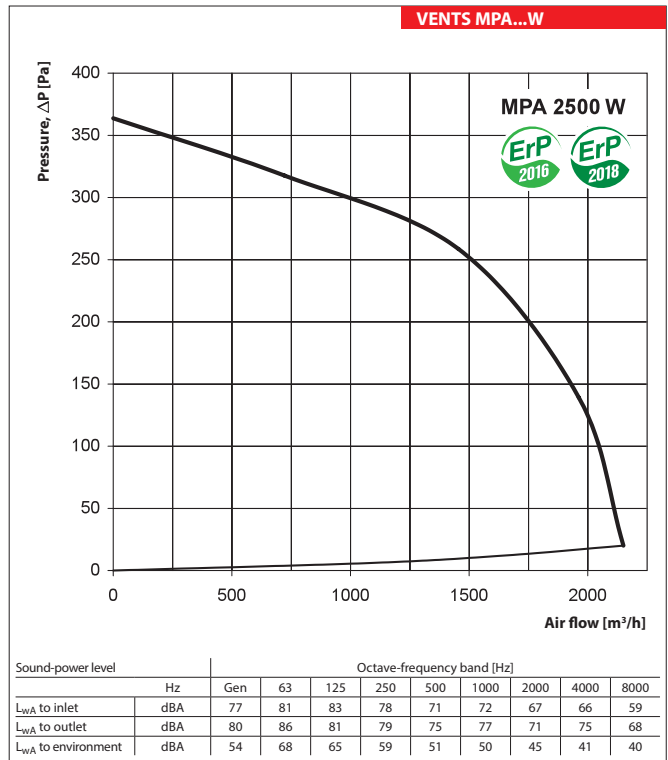
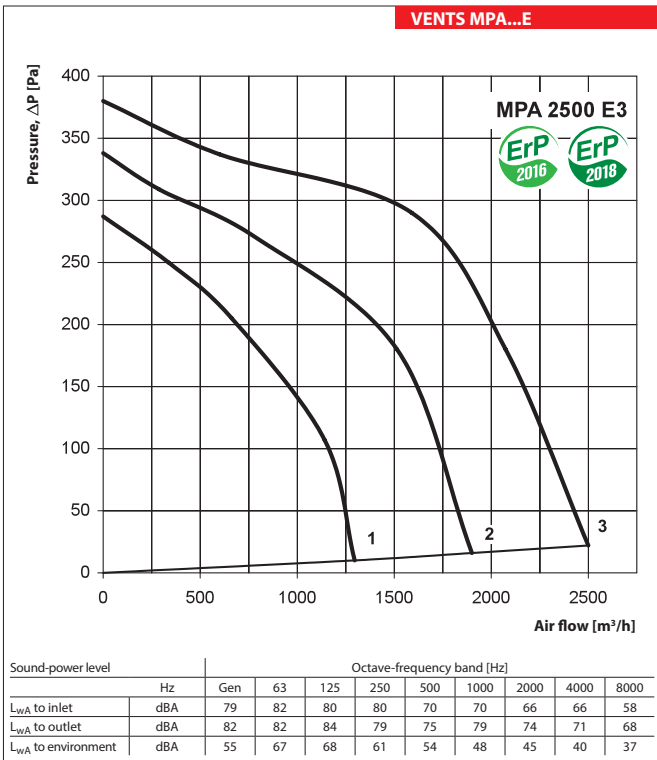

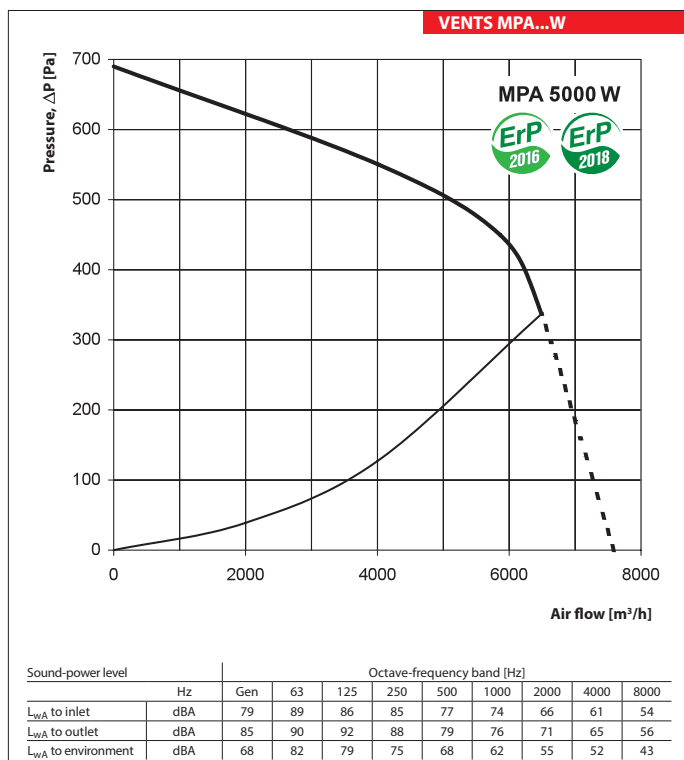
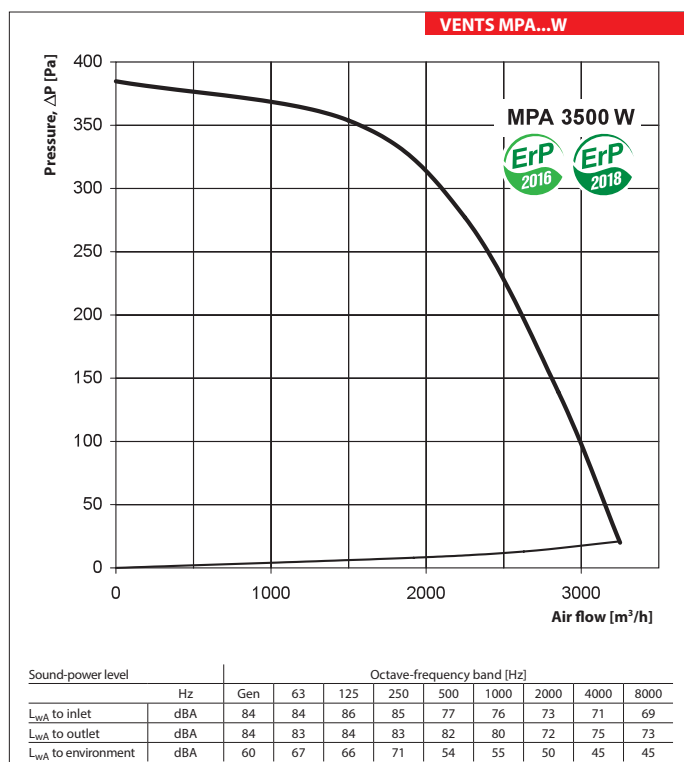
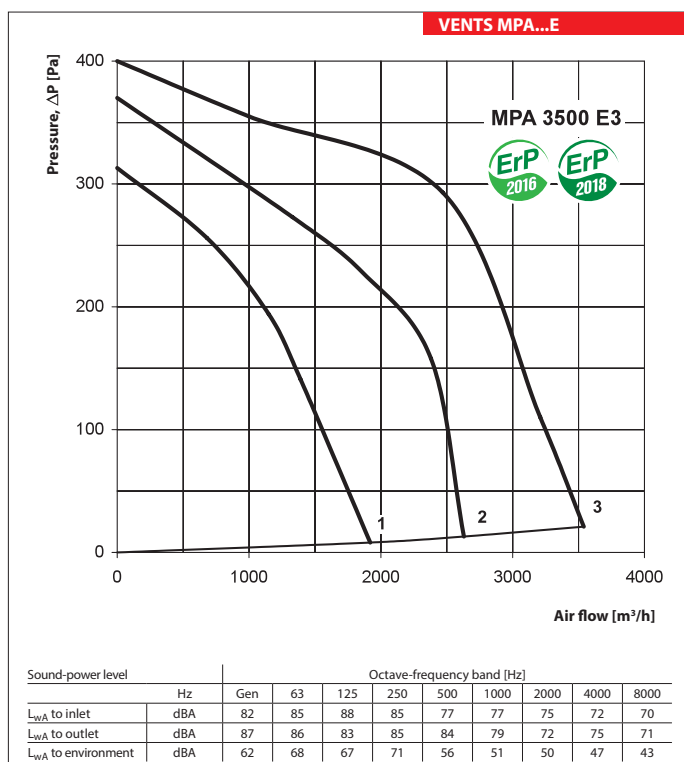

Accessories to supply units

Type	Replaceable filter	Filter type
MPA 800 E1		
MPA 1200 E3	SF 442x275x47 G4	panel filter
MPA 1800 E3	SF 390x545x47 G4	panel filter
MPA 2500 E3		
MPA 3200 E3	SF 653x440x47 G4	panel filter
MPA 3500 E3		
MPA 800 W	SF 442x275x47 G4	panel filter
MPA 1200 W		
MPA 1800 W	SF 390x545x47 G4	panel filter
MPA 2500 W		
MPA 3200 W	SF 653x440x47 G4	panel filter
MPA 3500 W		
MPA 5000 W	SFK 868x573x27 G4	pocket filter

Office ventilation example

Air supply and exhaust ventilation in the modern office can be arranged as follows. Air handling MPA unit, exhaust fan complying with MPA unit characteristics, intake and exhaust main air ducts are mounted in the hall behind the suspended ceiling. The branchings are laid into the office premises and air distribution units. Intake air from outside flows through the external grille, is filtered in the air handling unit,

heated to the required temperature and supplied to the office rooms through the branch duct system. Exhaust air is extracted outside through the external grille by means of the exhaust fan. Thus the office has the permanent fresh air supply, controllable air exchange, no draughts when opened windows, no dust and no noise.

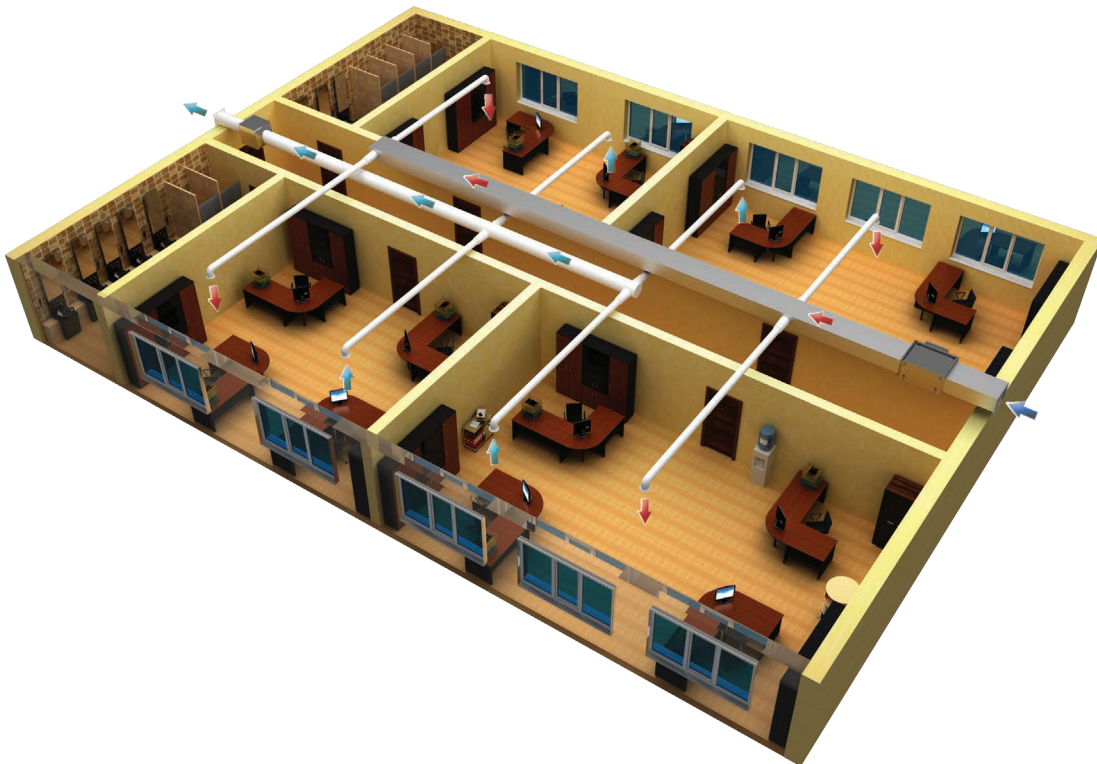

MPA unit office air exchange example

Hot water coil parameters

VENTS MPA...W

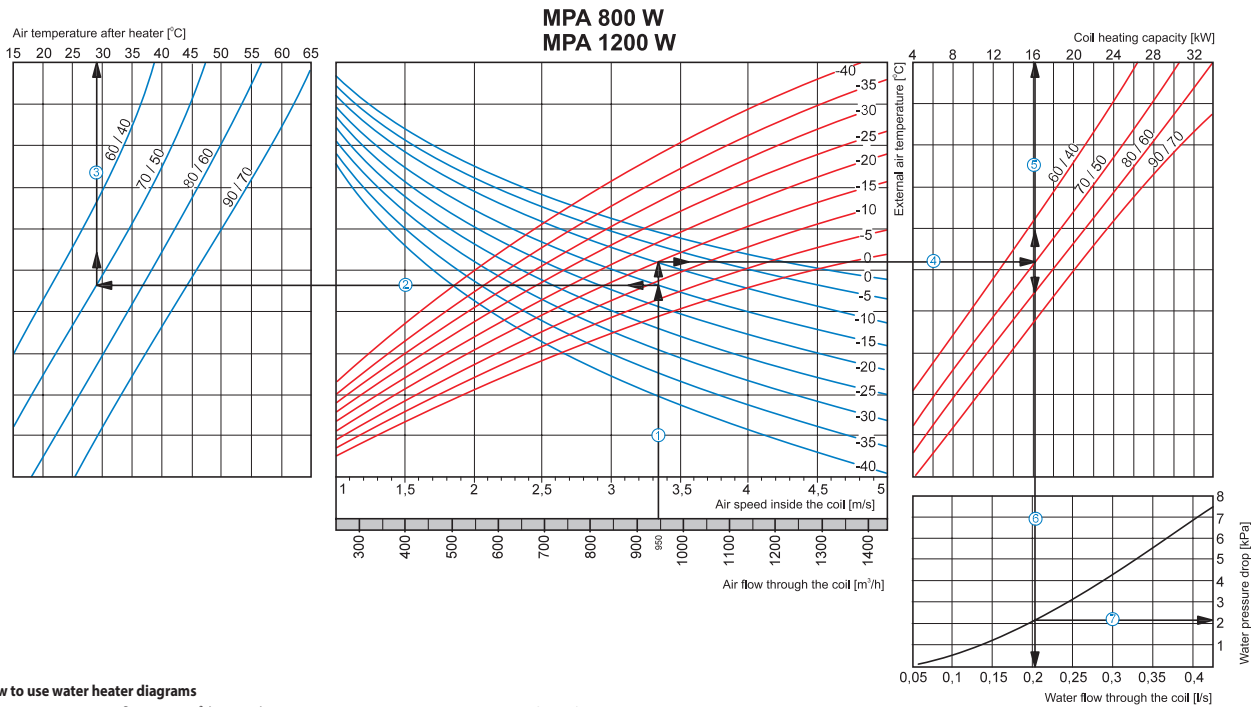

How to use water heater diagrams

System Parameters: Air flow = 950 m³/h. Outside air temperature = -15 °C. Water temperature (in/out) = 70/50 °C.

- Air Speed. Starting from 950 m³/h on the air flow scale draw a vertical line ① till the air speed axis which makes about 3.35 m/s.
- Supply air temperature. Prolong the line ① up to the point where it crosses the outside air temperature (blue curve), e.g. -15 °C; then draw a horizontal line ② from this point to the left till crossing water in/out temperature curve (70/50 °C). From this point draw a vertical line ③ to the supply air temperature axis on top of the graphic (+29 °C).
- Heating coil capacity. Prolong the line ① up to the point where it crosses the outside air temperature -15 °C (red curve) and draw a horizontal line ④ from this point to the right until it crosses water in/out temperature curve (70/50 °C), from here draw a vertical line ⑤ up to the scale representing the heating coil capacity (16 kW).
- Water flow. Prolong the line ⑤ down to water flow axis at the bottom of the graphic ⑥ (0.2 l/s).
- Water pressure drop. Draw the line ⑦ from the point where line ⑥ crosses the black curve to the pressure drop axis. (2.1 kPa).

VENTS MPA...W

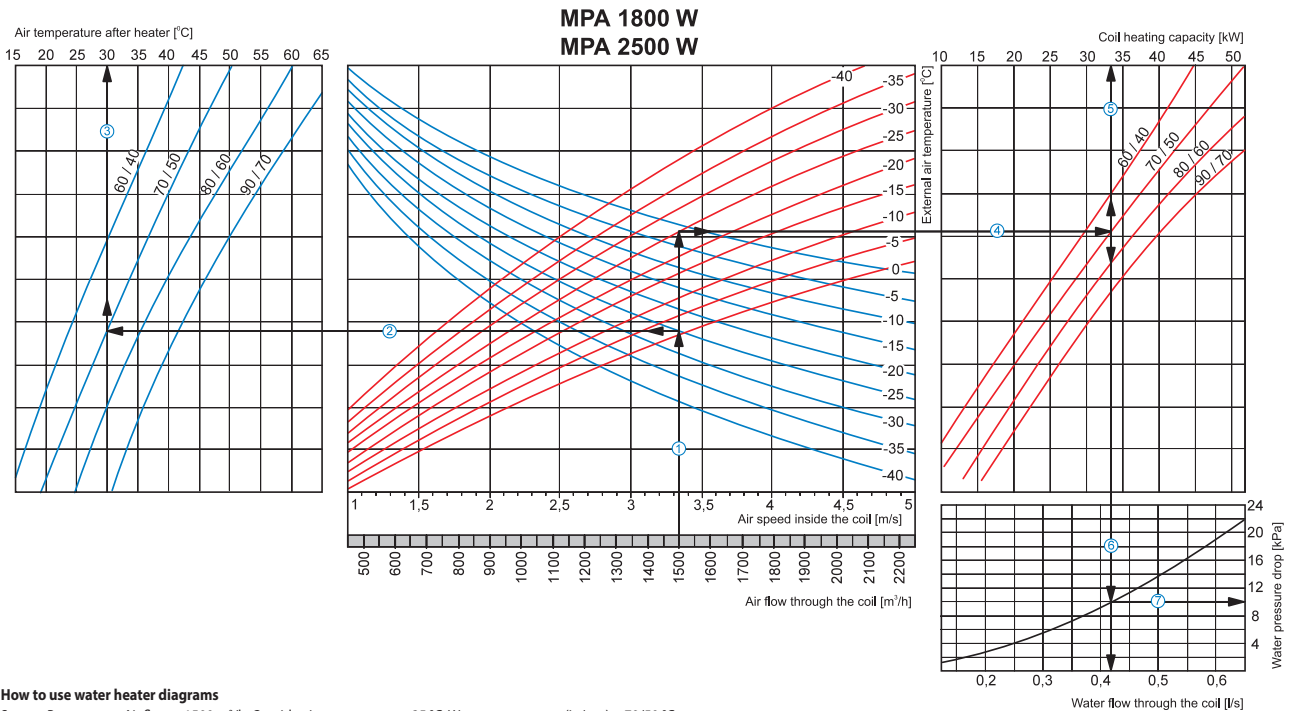

How to use water heater diagrams

System Parameters: Air flow = 1500 m³/h. Outside air temperature = -25 °C. Water temperature (in/out) = 70/50 °C.

- Air Speed. Starting from 1500 m³/h on the air flow scale draw a vertical line ① till the air speed axis which makes about (3.3 m/s).
- Supply air temperature. Prolong the line ① up to the point where it crosses the outside air temperature (blue curve), e.g. -25 °C; then draw a horizontal line ② from this point to the left till crossing water in/out temperature curve (70/50 °C). From this point draw a vertical line ③ to the supply air temperature axis on top of the graphic (+30 °C).
- Heating coil capacity. Prolong the line ① up to the point where it crosses the outside air temperature -25 °C (red curve) and draw a horizontal line ④ from this point to the right until it crosses water in/out temperature curve (70/50 °C), from here draw a vertical line ⑤ up to the scale representing the heating coil capacity (33.0 kW).
- Water flow. Prolong the line ⑤ down to water flow axis at the bottom of the graphic ⑥ (0.42 l/s).
- Water pressure drop. Draw the line ⑦ from the point where line ⑥ crosses the black curve to the pressure drop axis. (10.0 kPa).

Hot water coil parameters

VENTS MPA...W

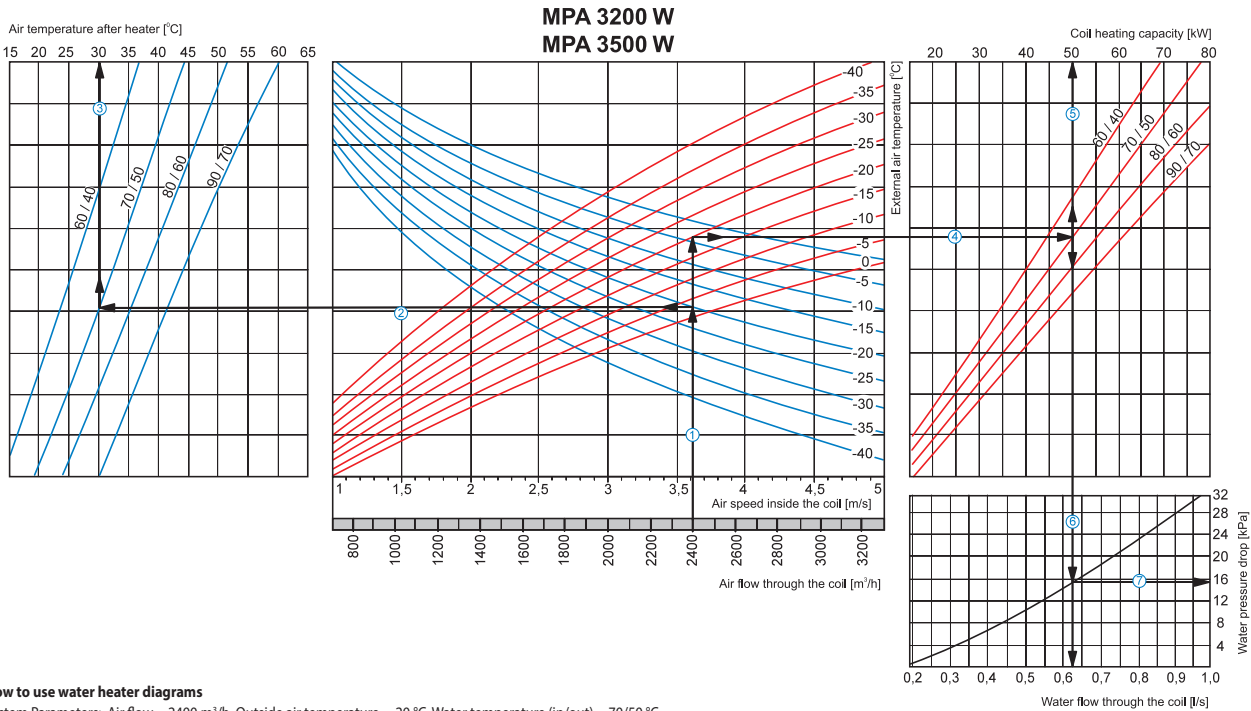

How to use water heater diagrams

System Parameters: Air flow = 2400 m³/h. Outside air temperature = -20 °C. Water temperature (in/out) = 70/50 °C.

- Air Speed. Starting from 2400 m³/h on the air flow scale draw a vertical line ① till the air speed axis which makes about 3.61 m/s.
- Supply air temperature. Prolong the line ① up to the point where it crosses the outside air temperature (blue curve), e.g. -20 °C; then draw a horizontal line ② from this point to the left till crossing water in/out temperature curve (70/50 °C). From this point draw a vertical line ③ to the supply air temperature axis on top of the graphic (+30 °C).
- Heating coil capacity. Prolong the line ① up to the point where it crosses the outside air temperature indicated as red curve (e.g., -20 °C) and draw a horizontal line ④ from this point to the right to the intersection of water in/out temperature curve (e.g., 70/50 °C). From this point draw a vertical line ⑤ up to the scale of heating coil capacity (50.0 kW).
- Water flow. Prolong the line ⑤ down to water flow axis at the bottom of the graphic (0.62 l/s).
- Water pressure drop. Draw the line ⑦ from the point where line ⑥ crosses the black curve to the pressure drop axis (15.0 kPa).

VENTS MPA...W

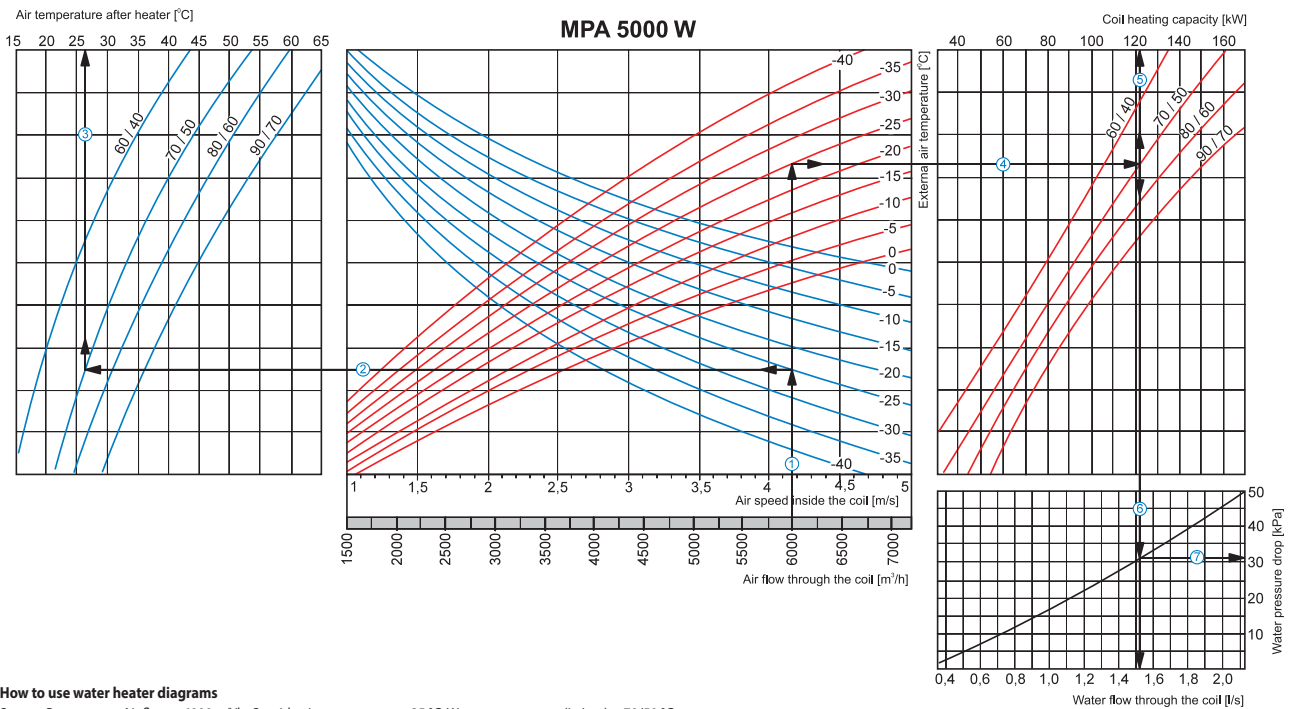

How to use water heater diagrams

System Parameters: Air flow = 6000 m³/h. Outside air temperature = -25 °C. Water temperature (in/out) = 70/50 °C.

- Air Speed. Starting from 6000 m³/h on the air flow scale draw a vertical line ① till the air speed axis which makes about 4.15 m/s.
- Supply air temperature. Prolong the line ① up to the point where it crosses the outside air temperature (blue curve), e.g. -25 °C; then draw a horizontal line ② from this point to the left till crossing water in/out temperature curve (70/50 °C). From this point draw a vertical line ③ to the supply air temperature axis on top of the graphic (+27 °C).
- Heating coil capacity. Prolong the line ① up to the point where it crosses the outside air temperature -25 °C (red curve) and draw a horizontal line ④ from this point to the right until it crosses water in/out temperature curve (70/50 °C), from here draw a vertical line ⑤ up to the scale representing the heating coil capacity (121 kW).
- Water flow. Prolong the line ⑤ down to water flow axis at the bottom of the graphic (6) (1.52 l/s).
- Water pressure drop. Draw the line ⑦ from the point where line ⑥ crosses the black curve to the pressure drop axis (31.0 kPa).

Series
VENTS PA...E



A16 control panel



Suspended air supply units with the air flow up to **3350 m³/h** in the sound- and heat-insulated casing with the electric heater

Series
VENTS PA...W



A13 control panel



Suspended air supply units with the air flow up to **4100 m³/h** in the sound- and heat-insulated casing with the water heater

■ **Description**

The PA unit is a ready to use ventilation unit for air filtration, warming and supply to the room.

■ **Casing**

Steel casing covered with aluzinc coating internally filled with 50 mm heat- and sound-insulating layer made of mineral wool.

■ **Filter**

Integrated panel G4 filter ensures sufficient supply air purification (optionally F7).

■ **Heater**

The PA units are equipped with electric (PA...E model) or water (PA...W model) heater. Depending on the required heating capacity the water heaters are available in two-, three- or four-row modifications. The water heaters are designed for max. operating pressure 1.0 MPa (10 bar) and max. operating temperature 95 °C of the heat medium.

■ **Fan**

The unit is equipped with a direct-driven centrifugal fan with backward curved blades and external rotor motor. The fan configuration ensures the best operating characteristics: high air flow and efficiency combined with low noise level.

■ **Mounting**

The unit is designed for indoor installation either on the floor, on the wall or under the ceiling by means of a seat angle with inserted vibration-damping element or attached to a wall with brackets. The unit can be mounted either in service spaces or in main premises above the suspended ceiling, in the pocket or the unit can be placed directly in the room. All the electrical connections are performed through the terminal box placed in the connection box. PA supply units are supplied with the fastening brackets to facilitate mounting. The unit can be mounted in any position but the vertical one with vertical air downstream because the electrical heating elements are not allowed under the fan. Access for the unit maintenance and filter cleaning shall be provided. The PA...W unit design

enables to lead the water heater pipes to the right or to the left while mounting. The pipes are directed on the right on supply air side by default.

■ **Control and automation**

Possible option:
Integrated control and automation system for speed (air flow) control and setting supply air temperature. The unit may be remotely controlled from the external control panel fixed on wire.

■ **PA...E control and protection functions**

- ▶ control from the control panel: switching the unit on/off, fan speed selection (low/medium/high speed), selecting heating/cooling modes (if connected to duct heater);
- ▶ maintaining supply air temperature set from the control panel by smooth heating capacity control;
- ▶ smooth frequency speed control of the fan;
- ▶ safe start-up/shutdown of the fans;
- ▶ Active overheating protection of the electric heating elements by the temperature sensor and by the thermostats activated at 60 °C with automatic reset and

Designation key

Series	Unit standard size	Heater type	Row number of the heater	Integrated control system
VENTS PA	01; 02; 03; 04	E: electric W: water	2: two rows; 3: three rows; 4: four rows	LCD: integrated automation with A16 control panel (PA...E) or A13 (PA...W)

Accessories

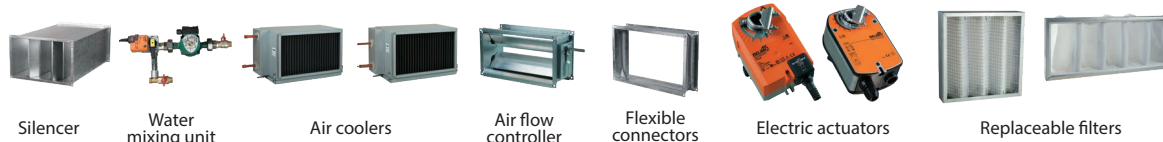

at 90 °C with manual reset. Blowing of the electric heating elements for heat removal at the end of the heating cycle.

- ▶ Filter clogging control with differential pressure sensor.
- ▶ Actuating the external air damper.
- ▶ Input from the fire alarm system.
- ▶ Control of the compressor and condensing block of the water cooler by the room temperature sensor (for models with external duct air cooler).
- ▶ Maintaining of set supply air temperature set from the control panel by smooth heating capacity control;
- ▶ smooth frequency fan speed control.

■ PA...W control and protection functions

- ▶ Control from the control panel: switching the unit on/off, fan speed selection (low/medium/high speed), selecting heating/cooling modes (if connected to duct cooler).
- ▶ Maintaining supply air temperature set from the control panel by controlling the circulation pump and actuating the heat medium regulating valve; input

from the heat medium flow switch (pump alarm).

- ▶ Safe start-up/ shutdown of the fans, warming up of the water heater before start-up; return heat medium temperature control when the fan is off.
- ▶ Freezing protection of the water heating coils by the exhaust temperature sensor and the return heat medium temperature sensor.
- ▶ Control of the compressor and condensing unit of the water cooler by the room temperature sensor (for the models equipped with a duct air cooler).
- ▶ Filter clogging degree with differential pressure sensor.
- ▶ Actuating the external air damper with a return spring.
- ▶ Unit shut down at signal from the fire alarm system.

■ Supplementary equipment

The mixing units USWK are recommended for smooth supply air temperature regulation in the units equipped with water heaters. The mixing unit USWK with three-way heat medium regulating valve and circulation pump provides smooth heating

capacity regulation and minimizes the water heater freezing danger. To disable uncontrollable air flow when the fan is off it is recommended to install the air damper with servo actuator from outside at the unit inlet. To protect the water heater against cold intake air in case of power failure for the units with water heaters (PA...W) it is recommended to install the air damper with a return spring. For attenuation of sound generated by the fan it is recommended to install the duct silencer (refer SR). For vibration absorbing it is recommended to install the flexible anti-vibration connectors (refer VVG) on both sides of the unit.

Unit overall dimensions

Type	Dimensions [mm]									
	B	B1	B2	B3	H	H1	H2	L	L1	
PA 01 E	400	420	624	582	200	220	374	1145	1106	
PA 02 E	500	520	689	646	300	320	447	1250	1212	
PA 03 E	600	620	888	744	350	370	500	1252	1212	
PA 01 W	400	420	624	582	200	220	374	1145	1106	
PA 02 W	500	520	689	646	300	320	447	1250	1212	
PA 03 W	600	620	787	744	350	370	500	1252	1212	
PA 04 W	700	720	888	844	400	420	546	1302	1262	

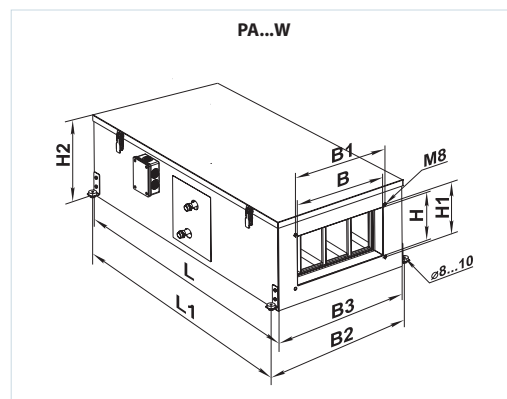
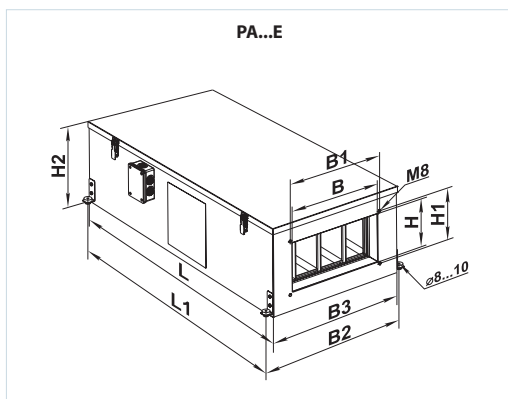

SUPPLY UNITS

Technical data

	PA 01 E	PA 01 W2	PA 01 W4	PA 02 E	PA 02 W2	PA 02 W4
Voltage [V/50 Hz]		3~400		3~400		
Maximum fan power [W]		320		620		
Fan current [A]		0.55		1.05		
Electric heater power [kW]	12.0	–		18.0	–	
Electric heater current [A]	17.4	–		26.0	–	
Number of water (glycol) coil rows	–	2	4	–	2	4
Total unit power [kW]	12.32	0.32		18.62	0.62	
Total unit current [A]	17.95	0.55		27.05	1.05	
Air flow [m³/h]	1275	1200		2500	2350	
RPM [min ⁻¹]		2700		2690		
Noise level at 3m [dBA]		51		54		
Transported air temperature [°C]		-25...+40		-25...+40		
Casing material		aluzinc		aluzinc		
Insulation		50 mm mineral wool		50 mm mineral wool		
Filter	panel filter G4	G4 (F7) pocket type*		panel filter G4	G4 (F7) pocket type*	
Connected air duct size [mm]		400x200		500x300		
Mass [kg]	56	55	57	61	61	63

*option

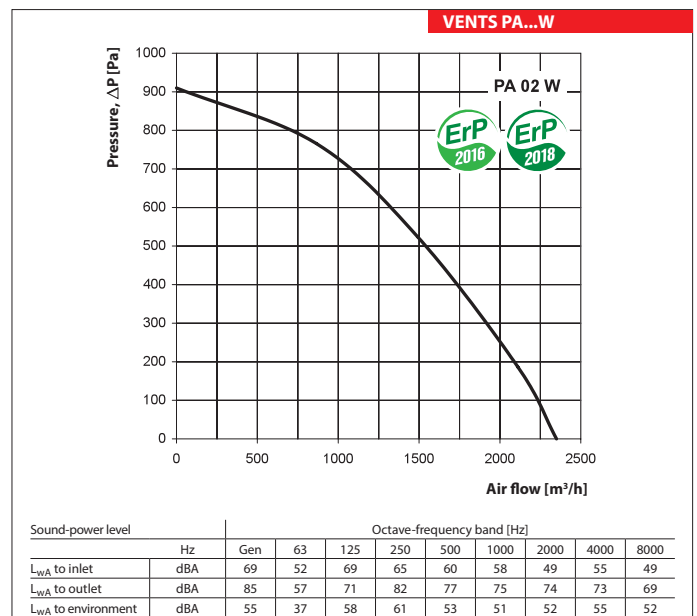
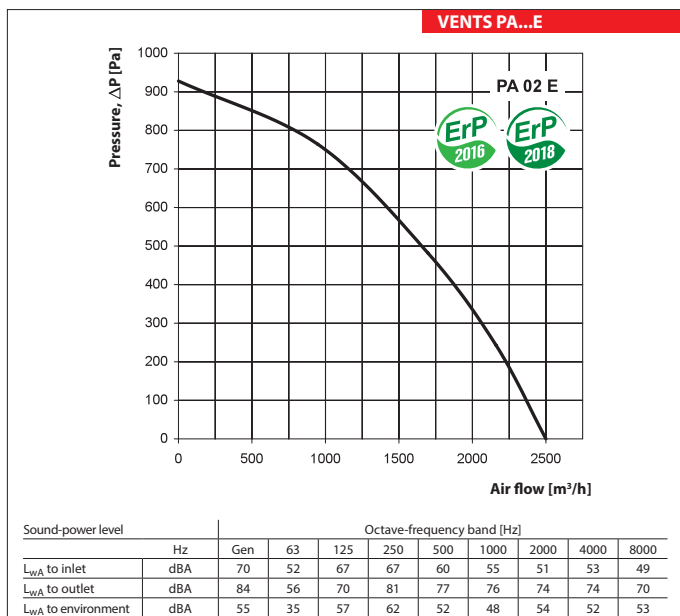
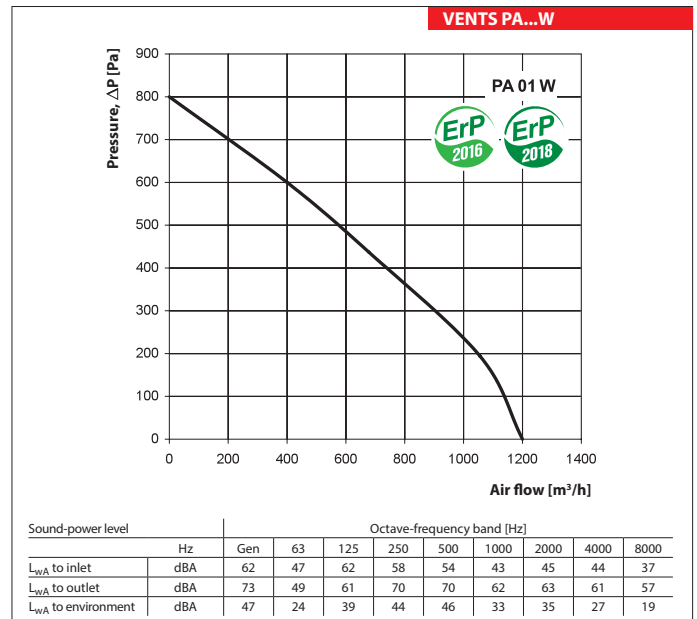
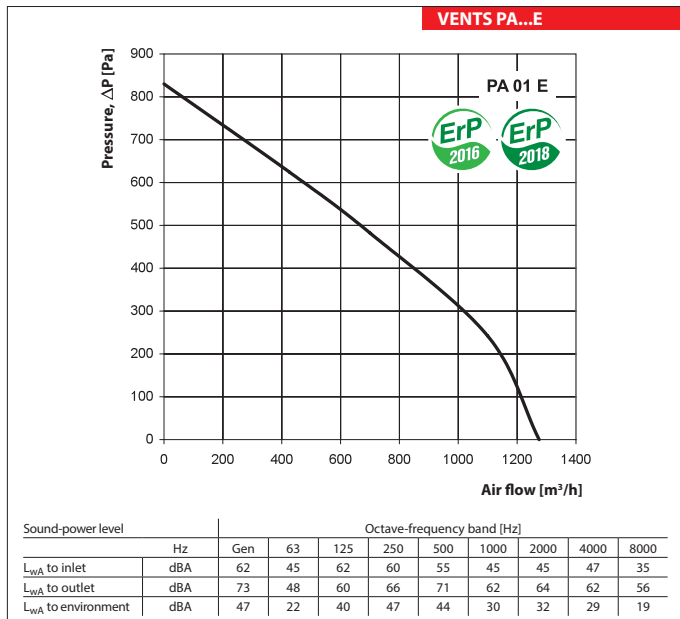

Technical data

	PA 03 E	PA 03 W2	PA 03 W4	PA 04 W2	PA 04 W3
Voltage [V/50 Hz]		3~400			3~400
Maximum fan power [W]		1330			2300
Fan current [A]		2.4			4.3
Electric heater power [kW]	21.0	-			-
Electric heater current [A]	30.0	-			-
Number of water (glycol) coil rows	-	2	4	2	3
Total unit power [kW]	22.33	1.33		2.30	
Total unit current [A]	32.4	2.4		4.3	
Air flow [m³/h]	3350	3260		4100	
RPM [min ⁻¹]		2730		2840	
Noise level at 3m [dBA]		57		75	
Transported air temperature [°C]		-25...+40		-25...+40	
Casing material		aluzinc		aluzinc	
Insulation		50 mm mineral wool		50 mm mineral wool	
Filter	panel filter G4	G4 (F7) pocket type*		G4 (F7) pocket type*	
Connected air duct size [mm]		600x350		700x400	
Mass [kg]	91	91	94	107	110

*option

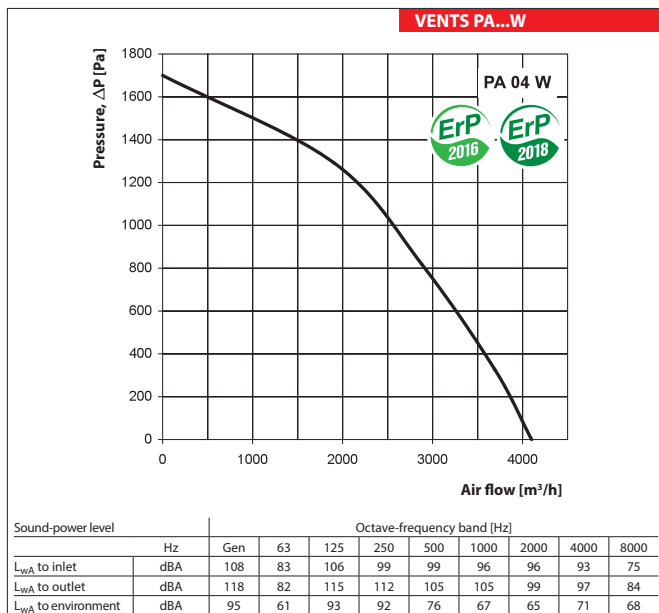
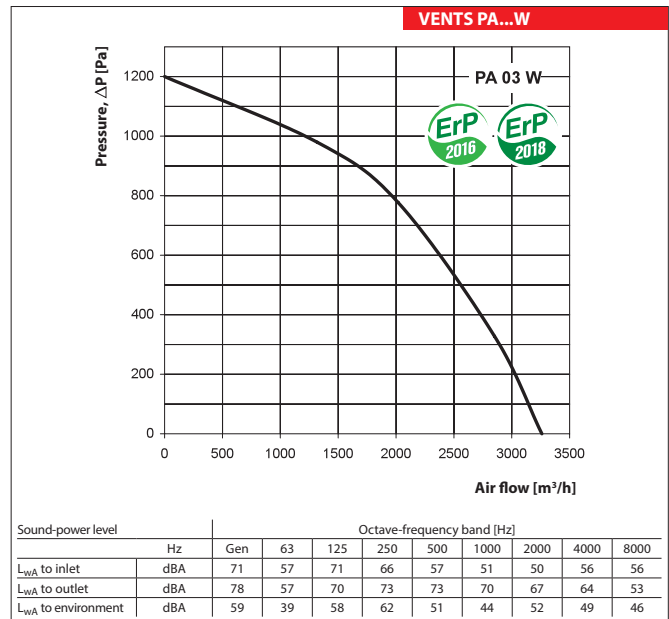
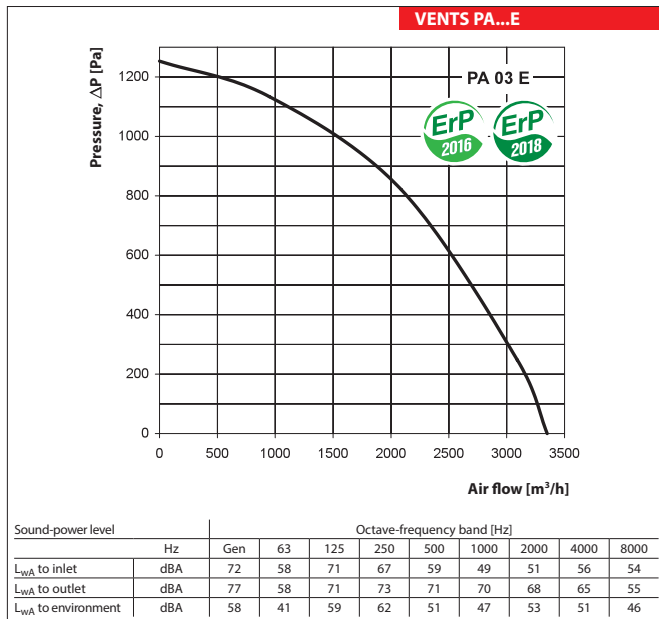

Accessories to supply units

Type	G4 replaceable filter	F7 replaceable filter	Filter type
PA 01 E	SF 475x270x48 G4	-	panel filter
PA 02 E	SF 540x340x48 G4	-	panel filter
PA 03 E	SF 635x395x48 G4	-	panel filter
PA 01 W2	SFK 474x269x27 G4	SFK 474x269x27 F7	pocket filter
PA 02 W2	SFK 538x342x27 G4	SFK 538x342x27 F7	pocket filter
PA 02 W4	SFK 538x342x27 G4	SFK 538x342x27 F7	pocket filter
PA 03 W2	SFK 637x395x27 G4	SFK 637x395x27 F7	pocket filter
PA 03 W4	SFK 637x395x27 G4	SFK 637x395x27 F7	pocket filter
PA 04 W2	SFK 737x441x27 G4	SFK 737x441x27 F7	pocket filter
PA 04 W3	SFK 737x441x27 G4	SFK 737x441x27 F7	pocket filter

Hot water coil parameters

VENTS PA...W

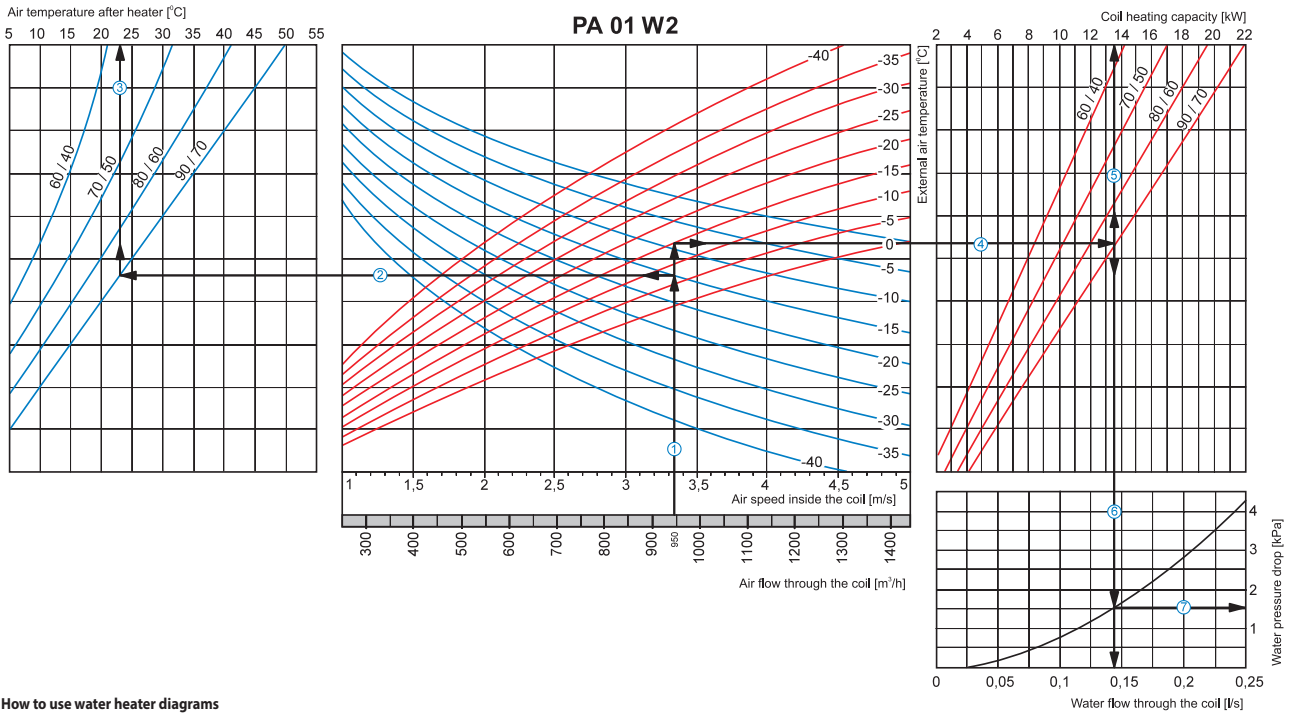

How to use water heater diagrams

System Parameters: Air flow = 950 m³/h. Outside air temperature = -15 °C. Water temperature (in/out) = 90/70 °C.

- Air Speed. Starting from 950 m³/h on the air flow scale draw a vertical line ① till the air speed axis which makes about 3.35 m/s.
- Supply air temperature. Prolong the line ① up to the point where it crosses the outside air temperature (blue curve, e.g. -15 °C); then draw a horizontal line ② from this point to the left till crossing water in/out temperature curve (e.g. 90/70 °C). From this point draw a vertical line ③ to the supply air temperature axis on top of the graphic (+23 °C).
- Heating coil capacity. Prolong the line ① up to the point where it crosses the outside air temperature (e.g. -15 °C, red curve) and draw a horizontal line ④ from this point to the right until it crosses water in/out temperature curve (90/70 °C), from here draw a vertical line ⑤ up to the scale representing the heating coil capacity (13.5 kW).
- Water flow. Prolong the line ⑤ down to water flow axis at the bottom of the graphic ⑥ (0.14 l/s).
- Water pressure drop. Draw the line ⑦ from the point where the line ⑥ crosses the black curve to the pressure drop axis. (1.5 kPa).

VENTS PA...W

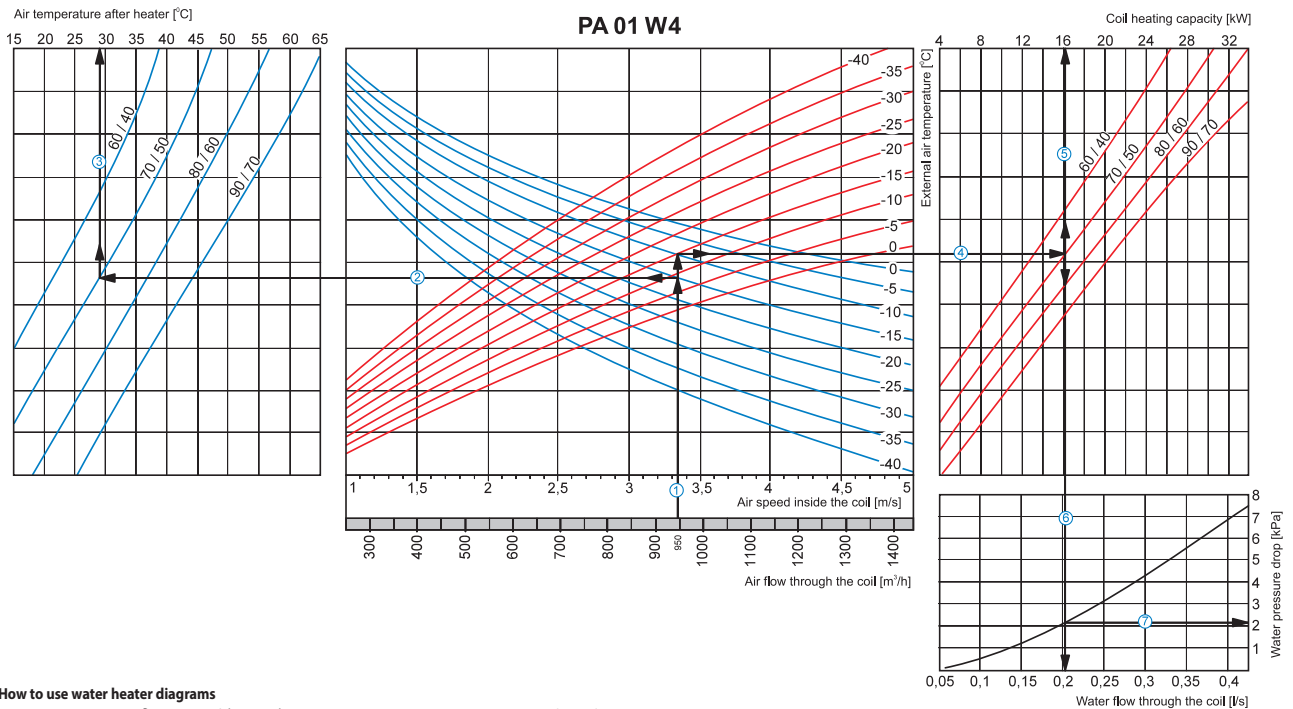

How to use water heater diagrams

System Parameters: Air flow = 950 m³/h. Outside air temperature = -15 °C. Water temperature (in/out) = 70/50 °C.

- Air Speed. Starting from 950 m³/h on the air flow scale draw a vertical line ① till the air speed axis which makes about 3.35 m/s.
- Supply air temperature. Prolong the line ① up to the point where it crosses the outside air temperature (blue curve, e.g. -15 °C); then draw a horizontal line ② from this point to the left till crossing water in/out temperature curve (e.g. 70/50 °C). From this point draw a vertical line ③ to the supply air temperature axis on top of the graphic (+29 °C).
- Heating coil capacity. Prolong the line ① up to the point where it crosses the outside air temperature (e.g. -15 °C, red curve) and draw a horizontal line ④ from this point to the right until it crosses water in/out temperature curve (e.g. 70/50 °C), from here draw a vertical line ⑤ up to the scale representing the heating coil capacity (16.0 kW).
- Water flow. Prolong the line ⑤ down to water flow axis at the bottom of the graphic ⑥ (0.2 l/s).
- Water pressure drop. Draw the line ⑦ from the point where the line ⑥ crosses the black curve to the pressure drop axis. (2.1 kPa).

Hot water coil parameters

VENTS PA...W

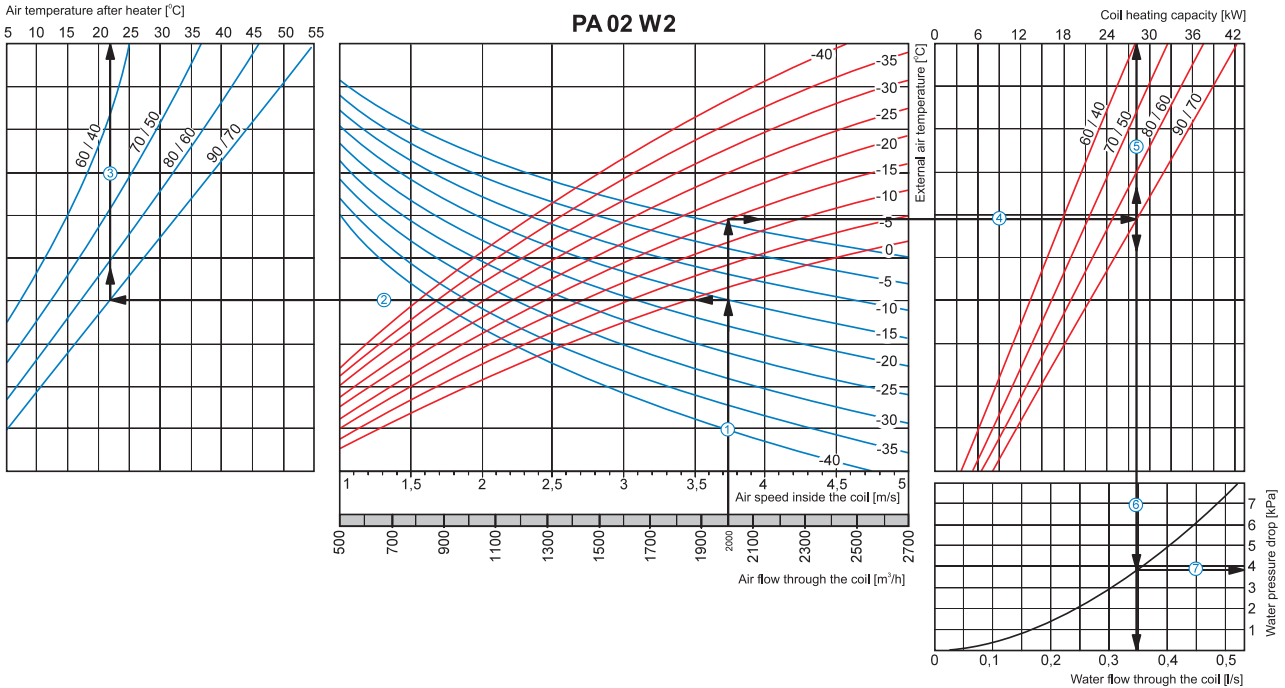

How to use water heater diagrams

System Parameters: Air flow = 2000 m³/h. Outside air temperature = -15 °C. Water temperature (in/out) = 90/70 °C.

- Air Speed. Starting from 2000 m³/h on the air flow scale draw a vertical line ① till the air speed axis which makes about 3.75 m/s.
- Supply air temperature. Prolong the line ① up to the point where it crosses the outside air temperature (blue curve, e.g. -15 °C); then draw a horizontal line ② from this point to the left till crossing water in/out temperature curve (e.g. 90/70 °C). From this point draw a vertical line ③ to the supply air temperature axis on top of the graphic (+22 °C).
- Heating coil capacity. Prolong the line ① up to the point where it crosses the outside air temperature (e.g. -15 °C, red curve) and draw a horizontal line ④ from this point to the right until it crosses water in/out temperature curve (e.g., 90/70 °C), from here draw a vertical line ⑤ up to the scale representing the heating coil capacity (28.0 kW).
- Water flow. Prolong the line ⑤ down to water flow axis at the bottom of the graphic ⑥ (0.35 l/s).
- Water pressure drop. Draw the line ⑦ from the point where the line ⑥ crosses the black curve to the pressure drop axis. (3.8 kPa).

VENTS PA...W

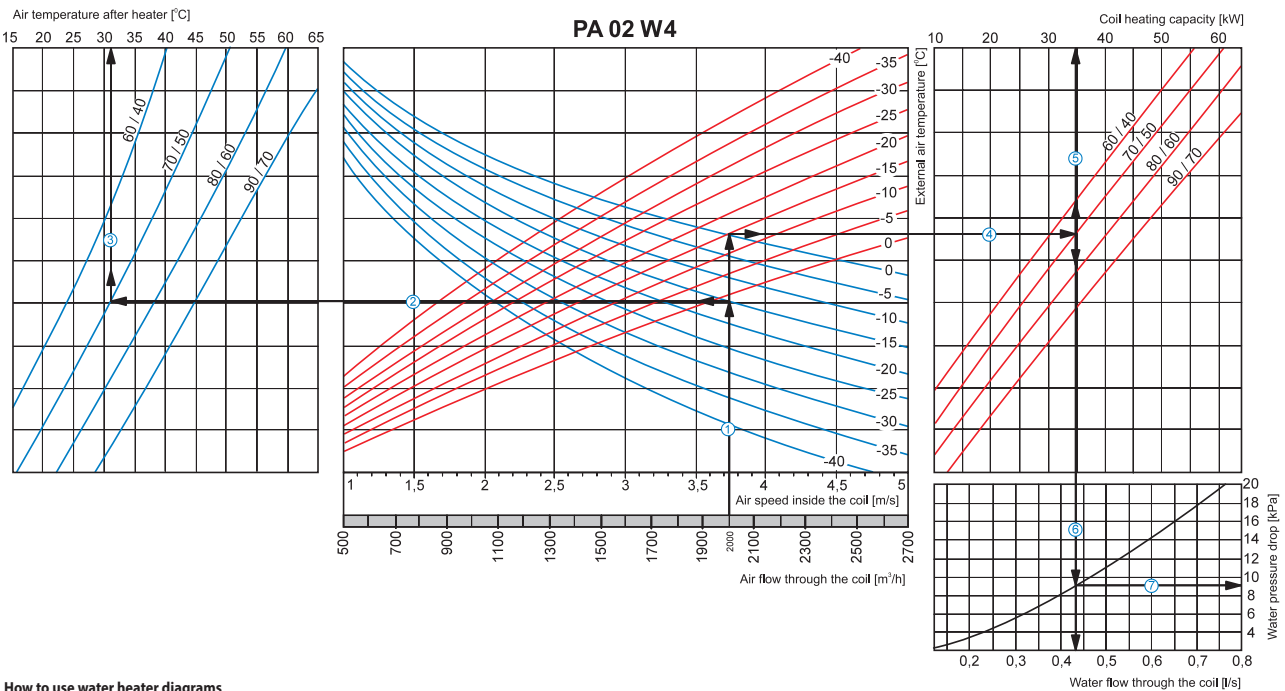

How to use water heater diagrams

System Parameters: Air flow = 2000 m³/h. Outside air temperature = -15 °C. Water temperature (in/out) = 70/50 °C.

- Air Speed. Starting from 2000 m³/h on the air flow scale draw a vertical line ① till the air speed axis which makes about 3.75 m/s.
- Supply air temperature. Prolong the line ① up to the point where it crosses the outside air temperature (blue curve, e.g. -15 °C); then draw a horizontal line ② from this point to the left till crossing water in/out temperature curve (e.g. 70/50 °C). From this point draw a vertical line ③ to the supply air temperature axis on top of the graphic (+31 °C).
- Heating coil capacity. Prolong the line ① up to the point where it crosses the outside air temperature (e.g. -15 °C, red curve) and draw a horizontal line ④ from this point to the right until it crosses water in/out temperature curve (e.g., 70/50 °C), from here draw a vertical line ⑤ up to the scale representing the heating coil capacity (35.0 kW).
- Water flow. Prolong the line ⑤ down to water flow axis at the bottom of the graphic ⑥ (0.43 l/s).
- Water pressure drop. Draw the line ⑦ from the point where the line ⑥ crosses the black curve to the pressure drop axis. (9.0 kPa).

Hot water coil parameters

VENTS PA...W

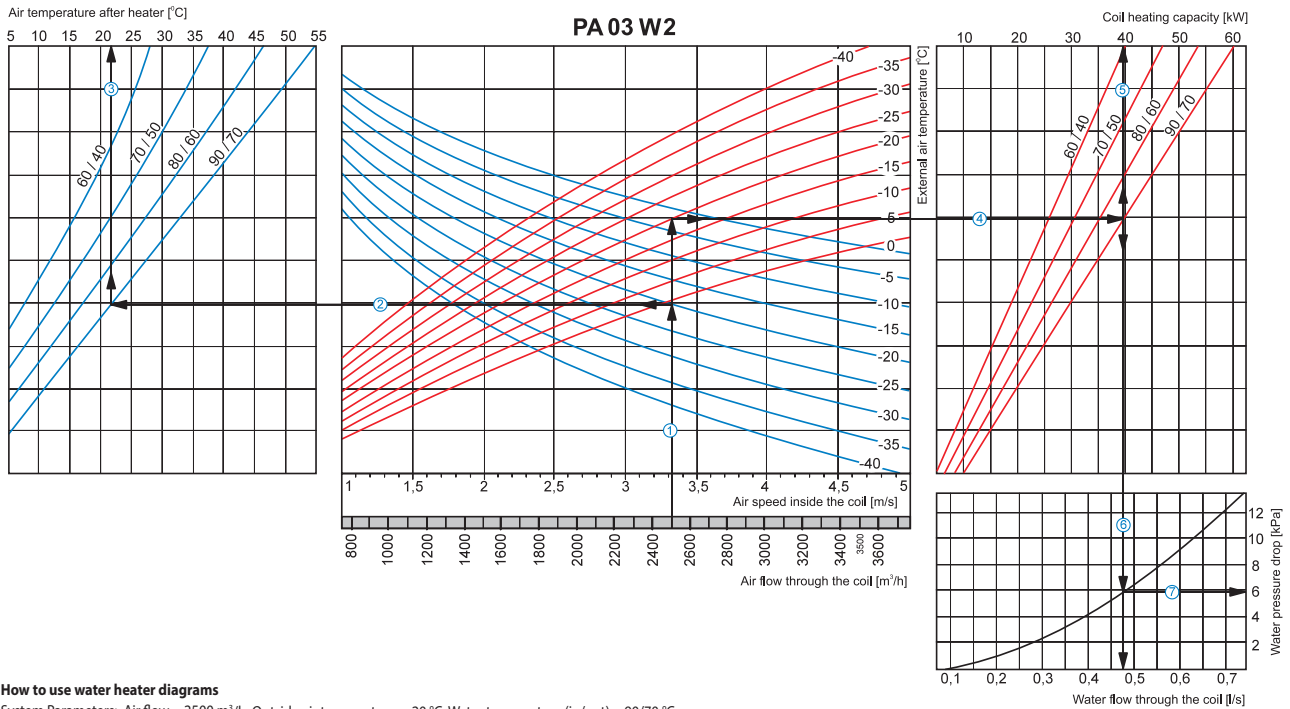

How to use water heater diagrams

System Parameters: Air flow = 2500 m³/h. Outside air temperature = -20 °C. Water temperature (in/out) = 90/70 °C.

- Air Speed. Starting from 2500 m³/h on the air flow scale draw a vertical line ① till the air speed axis which makes about 3.32 m/s.
- Supply air temperature. Prolong the line ① up to the point where it crosses the outside air temperature (blue curve, e.g. -20 °C); then draw a horizontal line ② from this point to the left till crossing water in/out temperature curve (e.g. 90/70 °C). From this point draw a vertical line ③ to the supply air temperature axis on top of the graphic (+22 °C).
- Heating coil capacity. Prolong the line ① up to the point where it crosses the outside air temperature (e.g. -20 °C, red curve) and draw a horizontal line ④ from this point to the right until it crosses water in/out temperature curve (e.g., 90/70 °C), from here draw a vertical line ⑤ up to the scale representing the heating coil capacity (40.0 kW).
- Water flow. Prolong the line ⑤ down to water flow axis at the bottom of the graphic ⑥ (0.47 l/s).
- Water pressure drop. Draw the line ⑦ from the point where the line ⑥ crosses the black curve to the pressure drop axis. (6.0 kPa).

VENTS PA...W

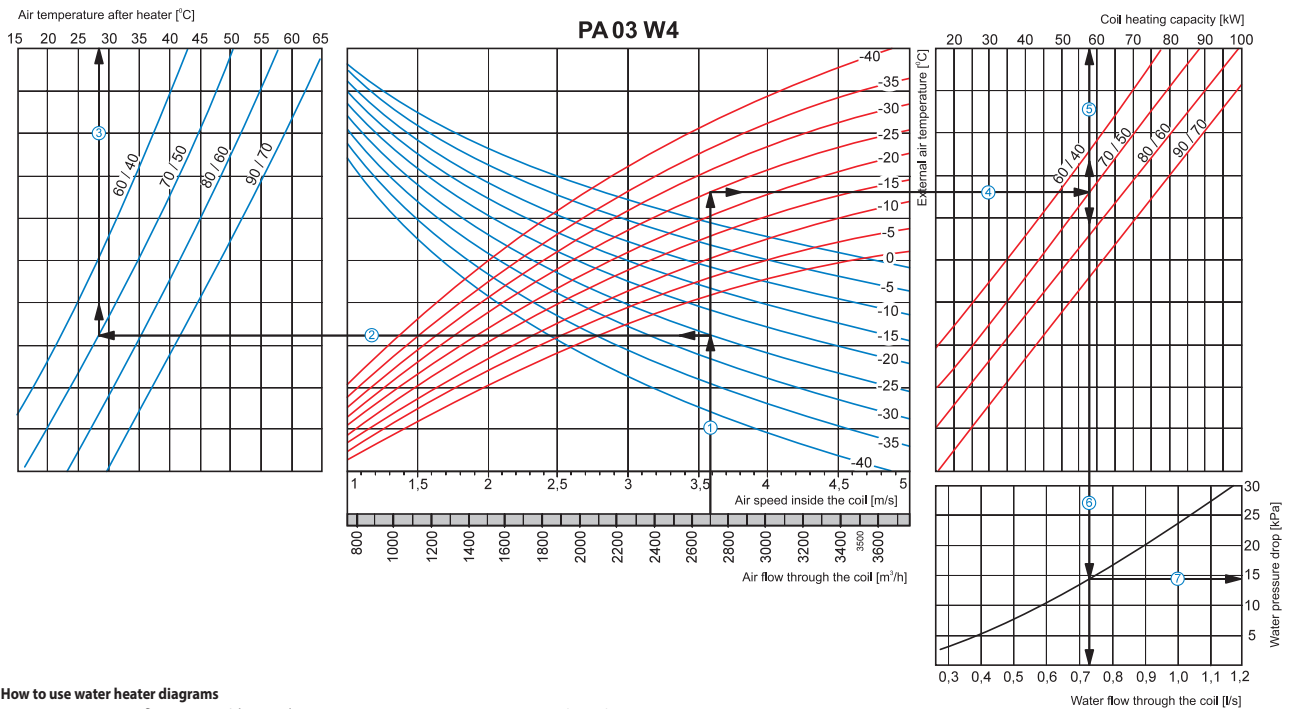

How to use water heater diagrams

System Parameters: Air flow = 2700 m³/h. Outside air temperature = -25 °C. Water temperature (in/out) = 70/50 °C.

- Air Speed. Starting from 2700 m³/h on the air flow scale draw a vertical line ① till the air speed axis which makes about 3.59 m/s.
- Supply air temperature. Prolong the line ① up to the point where it crosses the outside air temperature (blue curve, e.g. -25 °C); then draw a horizontal line ② from this point to the left till crossing water in/out temperature curve (e.g. 70/50 °C). From this point draw a vertical line ③ to the supply air temperature axis on top of the graphic (+28 °C).
- Heating coil capacity. Prolong the line ① up to the point where it crosses the outside air temperature (e.g. -25 °C, red curve) and draw a horizontal line ④ from this point to the right until it crosses water in/out temperature curve (e.g., 70/50 °C), from here draw a vertical line ⑤ up to the scale representing the heating coil capacity (58.0 kW).
- Water flow. Prolong the line ⑤ down to water flow axis at the bottom of the graphic ⑥ (0.73 l/s).
- Water pressure drop. Draw the line ⑦ from the point where the line ⑥ crosses the black curve to the pressure drop axis. (14.0 kPa).

Hot water coil parameters

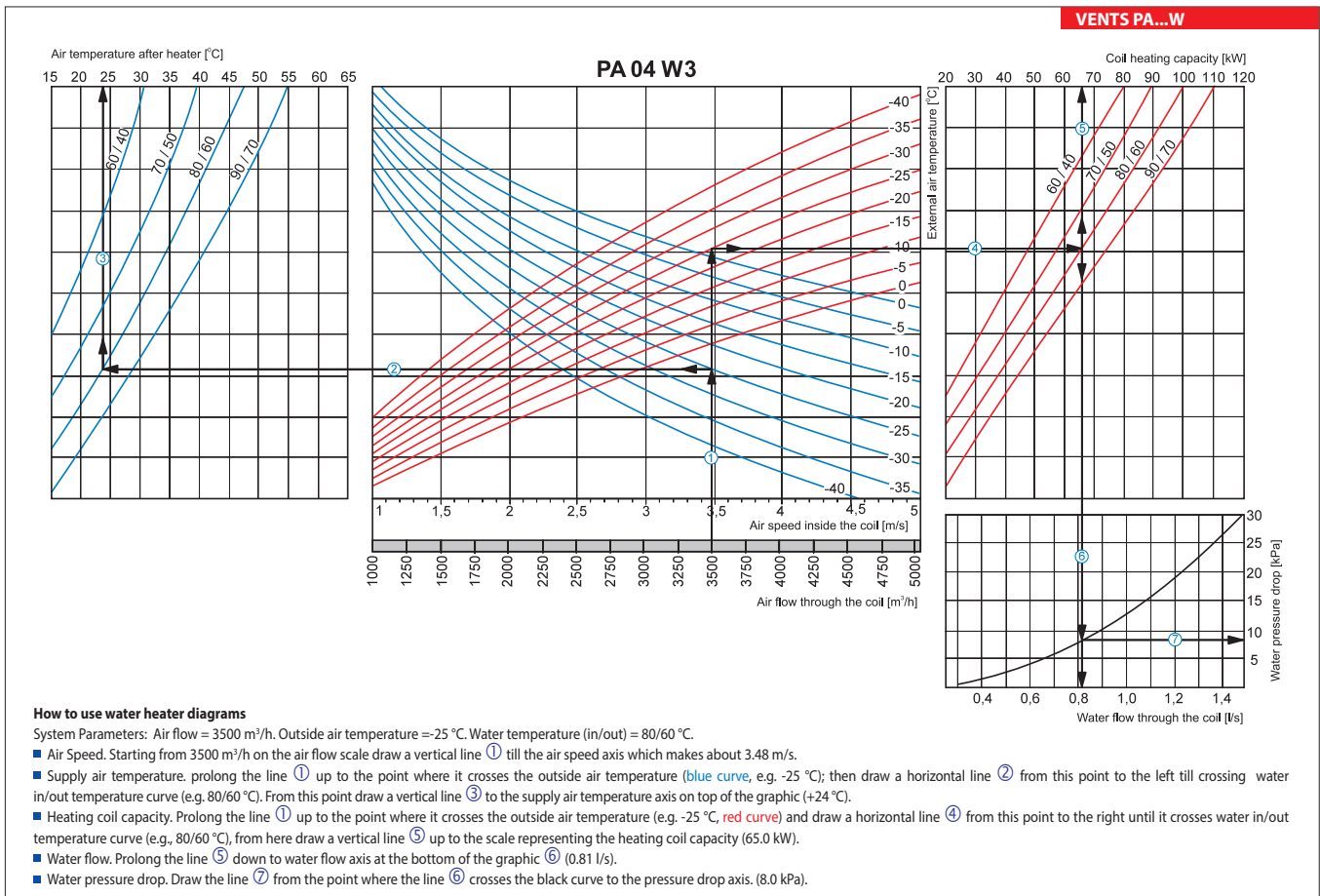
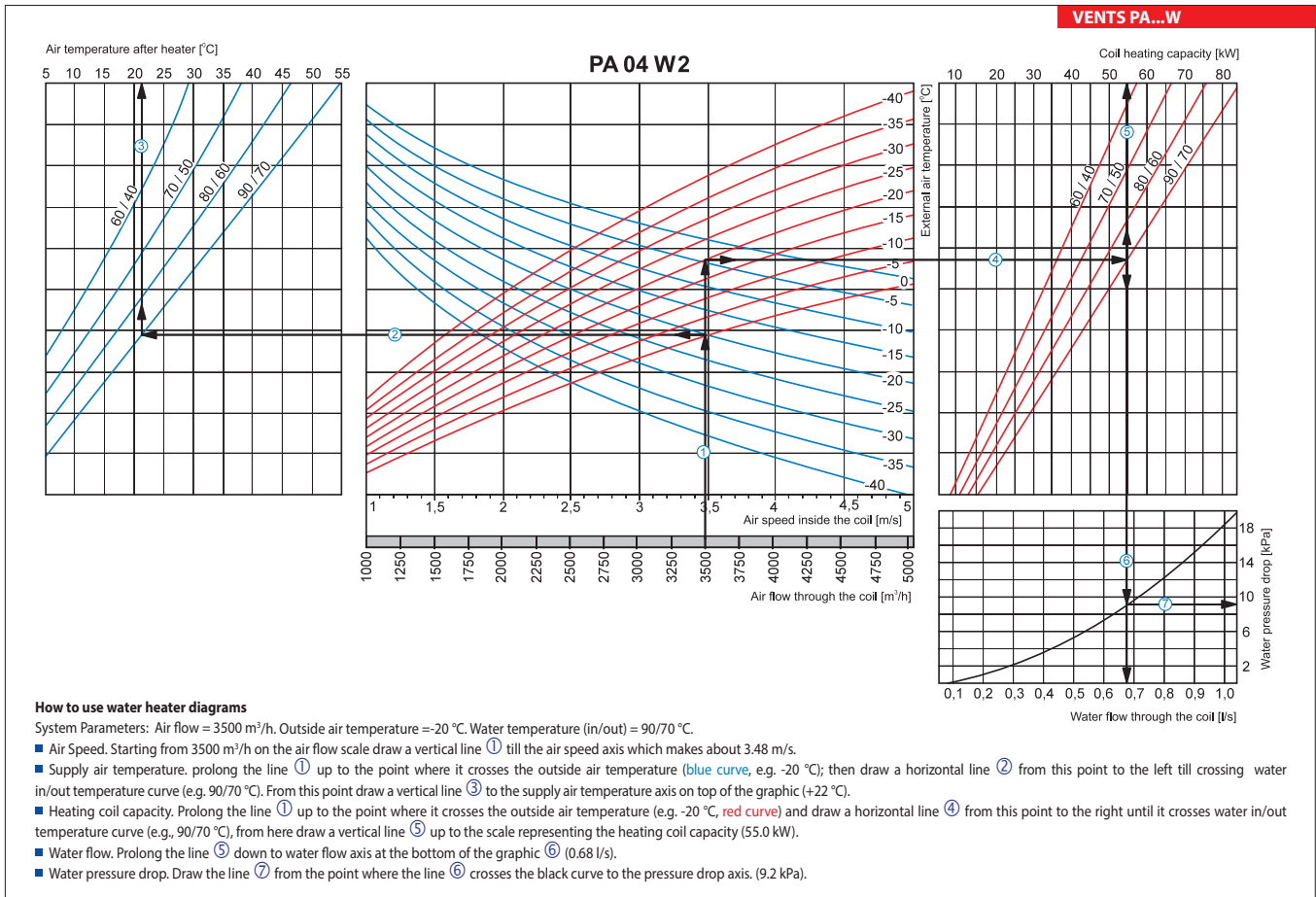

Series
SR



Series
SRF



■ **Applications**

Silencer is applied for noise absorption produced during the ventilating equipment operation and spread along the ducting systems. Suitable for installation into round ducts. The silencer reduces the noise level in the air duct significantly (refer the diagram «Noise level reduction»). For designing a ventilation system with low level of noise emission into the environment silencers should be used together with insulated fans.

■ **Design**

The galvanized steel casing of the SR silencer is filled with flameproof sound insulating material and equipped with protecting covering against fiber blowing-out. The SRF silencer casing consists of internal and external aluminium-alloy spiral seam tubes filled with flameproof sound insulating material. The casing inner surface is perforated and has the protecting over to prevent the fiber blowing-out. The minimum bending radius of the silencer is up to 2 diameters. Each standards size has several length modifications.

The SR and SRF silencers are equipped with connecting flanges with rubber sealing for airtight connection to the air ducts.

■ **Mounting**

The silencers can be mounted in any position. Installing several silencers in series is preferable to improve sound absorption effect. To prevent the flexible silencer sagging it should be fixed not only at the ends but also in the middle.

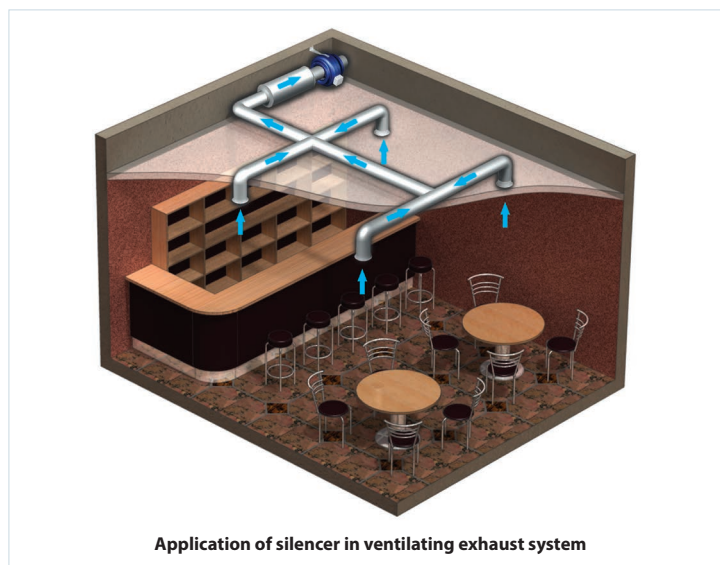

Designation key

Series	Air duct diameter [mm]	Length
SR SRF	100; 125; 150; 160; 200; 250; 315; 355; 400	600; 900; 1200; 2000

	Noise level reduction, dB (Octave-frequency band [Hz])							
	63 Hz	125 Hz	250 Hz	500 Hz	1000 Hz	2000 Hz	4000 Hz	8000 Hz
SR 100/600	4	8	10	20	34	30	13	14
SR 100/900	5	10	15	23	44	30	16	15
SR 100/1200	6	11	19	28	50	34	20	18
SR 125/600	3	5	6	15	28	17	10	9
SR 125/900	4	9	12	22	43	22	16	12
SR 125/1200	4	9	16	27	48	27	21	17
SR 150/600	2	4	8	16	32	11	7	7
SR 150/900	3	5	9	18	36	25	13	14
SR 150/1200	4	8	14	25	43	30	18	19
SR 160/600	2	4	8	17	33	11	7	7
SR 160/900	2	5	10	19	37	25	13	15
SR 160/1200	4	10	14	24	42	30	19	20
SR 200/600	2	4	6	10	27	13	7	7
SR 200/900	3	7	11	20	39	23	8	7
SR 200/1200	4	10	14	23	40	26	13	12
SR 250/600	4	5	6	11	22	12	7	6
SR 250/900	4	5	7	16	32	20	12	10
SR 250/1200	4	6	8	17	34	22	14	12
SR 315/600	2	4	5	10	17	9	6	5
SR 315/900	3	5	8	17	30	14	10	8
SR 315/1200	4	7	11	22	36	18	14	10

	Noise level reduction, dB (Octave-frequency band [Hz])							
	63 Hz	125 Hz	250 Hz	500 Hz	1000 Hz	2000 Hz	4000 Hz	8000 Hz
SRF 100/600	6	8	13	22	28	34	17	20
SRF 100/900	8	10	15	25	33	40	21	23
SRF 100/2000	10	15	24	48	53	51	39	36
SRF 125/600	4	7	14	20	31	31	13	12
SRF 125/900	5	9	16	23	36	37	17	16
SRF 125/2000	7	15	23	47	55	50	28	25
SRF 150/600	3	7	12	32	40	40	19	20
SRF 150/900	4	8	14	40	48	49	26	25
SRF 150/2000	5	10	21	42	50	48	26	25
SRF 160/600	3	7	12	20	25	24	10	12
SRF 160/900	3	8	13	21	28	28	13	16
SRF 160/2000	5	11	20	40	48	48	25	25
SRF 200/600	2	5	12	20	26	21	10	10
SRF 200/900	3	6	12	22	28	24	12	13
SRF 200/2000	4	11	22	42	51	34	19	23
SRF 250/600	2	3	8	16	22	13	10	10
SRF 250/900	2	4	9	18	25	16	11	12
SRF 250/2000	3	6	16	30	39	27	17	22
SRF 315/600	2	4	9	18	21	12	7	9
SRF 315/900	2	5	11	21	24	14	8	10
SRF 315/2000	4	7	17	34	39	24	14	18

Overall dimensions

Type	Dimensions [mm]			Weight [kg]
	∅D	∅D1	L	
SR 100/600	99	202	600	2.9
SR 100/900	99	202	900	4.0
SR 100/1200	99	202	1200	5.2
SR 125/600	125	225	600	3.3
SR 125/900	125	225	900	4.6
SR 125/1200	125	225	1200	5.9
SR 150/600	149	252	600	3.7
SR 150/900	149	252	900	5.1
SR 150/1200	149	252	1200	6.5
SR 160/600	159	252	600	3.7
SR 160/900	159	252	900	5.1
SR 160/1200	159	252	1200	6.5
SR 200/600	198	318	600	4.65
SR 200/900	198	318	900	6.45
SR 200/1200	198	318	1200	8.1
SR 250/600	248	358	600	5.6
SR 250/900	248	358	900	7.8
SR 250/1200	248	358	1200	10
SR 315/600	313	403	600	7.1
SR 315/900	313	403	900	10.1
SR 315/1200	313	403	1200	13
SR 355/600	353	453	600	8.3
SR 355/900	353	453	900	11.6
SR 355/1200	353	453	1200	14.9
SR 400/600	398	503	600	10,75
SR 400/900	398	503	900	14.5
SR 400/1200	398	503	1200	18.2

Type	Dimensions [mm]			Weight [kg]
	∅D	∅D1	L	
SRF 100/600	99	220	600	1.6
SRF 100/900	99	220	900	2.4
SRF 100/2000	99	220	2000	5.2
SRF 125/600	124	270	600	2.0
SRF 125/900	124	270	900	3.0
SRF 125/2000	124	270	2000	6.6
SRF 150/600	149	270	600	2.1
SRF 150/900	149	270	900	3.1
SRF 150/2000	149	270	2000	6.8
SRF 160/600	159	270	600	2.1
SRF 160/900	159	270	900	3.2
SRF 160/2000	159	270	2000	7.0
SRF 200/600	199	320	600	2.6
SRF 200/900	199	320	900	3.9
SRF 200/2000	199	320	2000	8.6
SRF 250/600	249	370	600	3.0
SRF 250/900	249	370	900	4.5
SRF 250/2000	249	370	2000	10.1
SRF 315/600	314	420	600	3.4
SRF 315/900	314	420	900	5.1
SRF 315/2000	314	420	2000	11.4

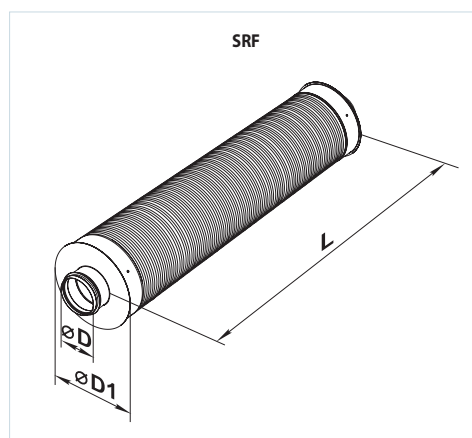
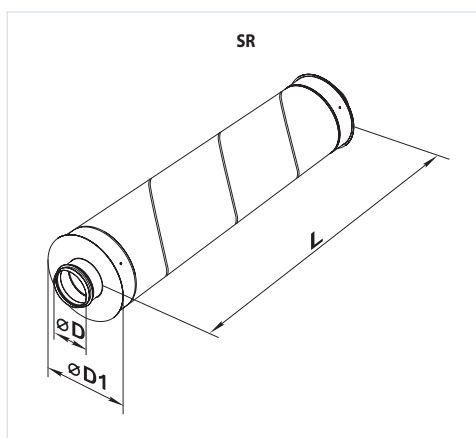

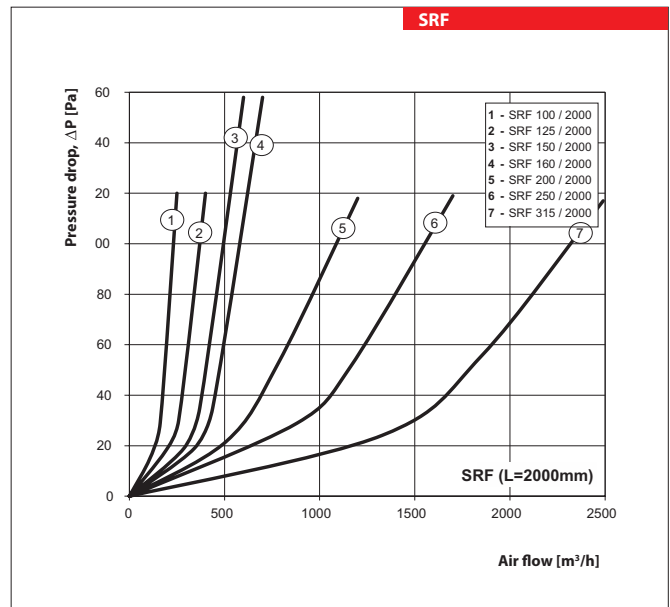
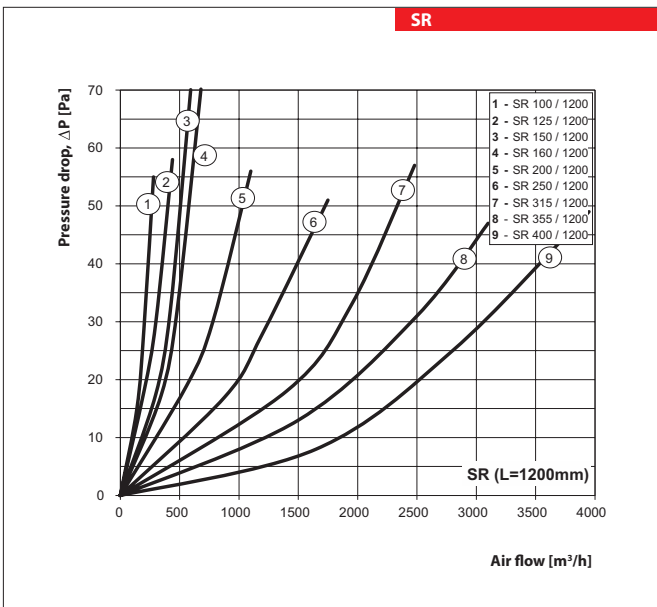
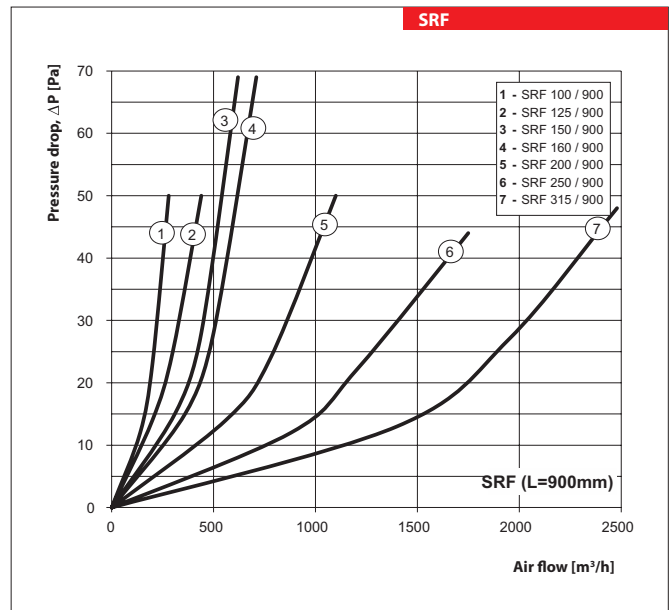
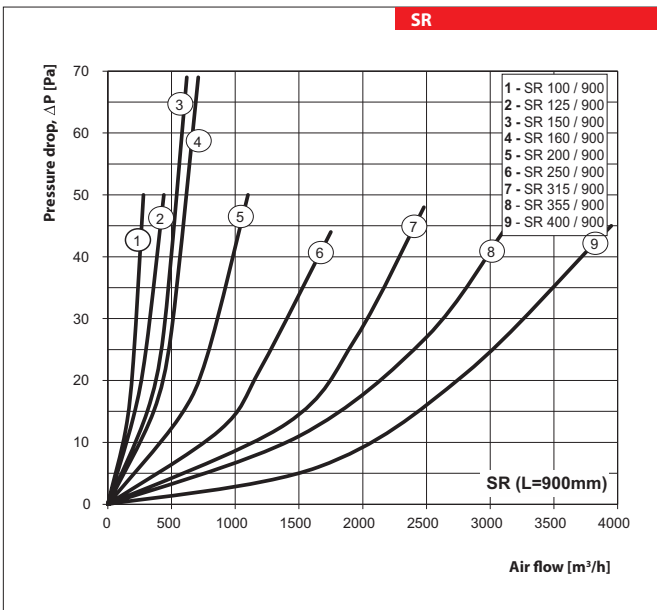
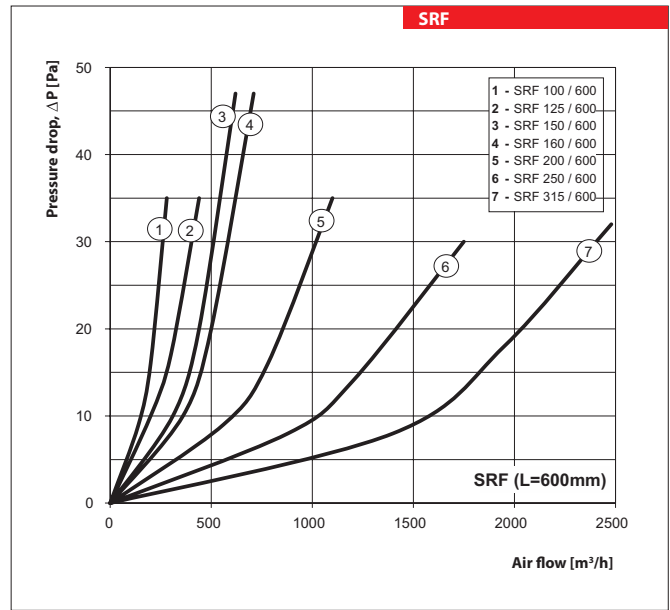
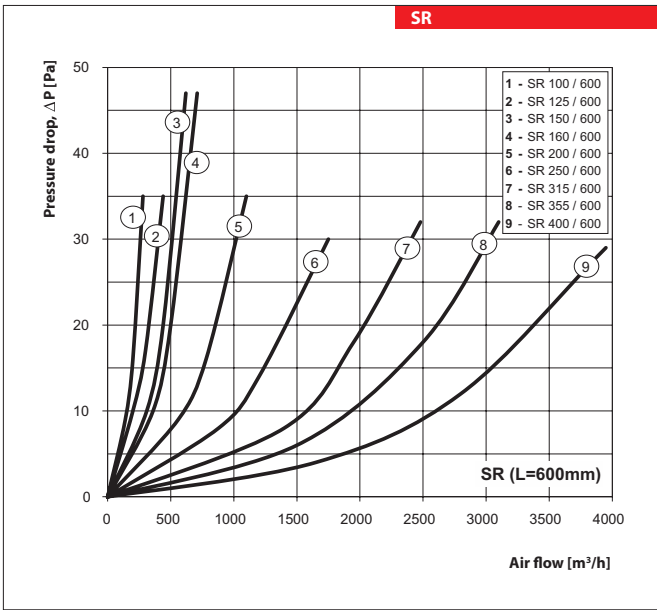

Series
SRP



Series
SRN



■ **Applications**

Silencer is applied for noise absorption produced during the ventilating equipment operation and spread along the ducting systems. Suitable for installation into round ducts. The silencer reduces the noise level in the air duct significantly (refer the diagram «Noise level reduction»). The silencer is applied jointly with the sound-insulated fan in case of high level requirements not only to the air duct but to the equipment altogether.

■ **Design**

SRP silencer consists of internal flexible air duct made of micro-perforated aluminum foil and laminated with

polyether film. The ducts are reinforced by the scroll frame made of high-carbon steel wire and outer polyethylene sleeve. Silencer supplied with high quality 25 mm sound insulation material. The silencer is equipped with the connecting flanges with rubber sealing that provides the airtight connection to the air ducts. Each standards size has several length modifications.

SRN silencer consists of the internal and external flexible air duct made of metallized polyether film. The ducts are reinforced by the scroll frame made of high-carbon steel wire. 25 mm mineral woollayer is laid between the air ducts. The silencer is equipped with connecting flanges with rubber sealing which provides the airtight

connection to the air ducts. Each standards size has several length modifications.

■ **Mounting**

The silencer design allows fixing it on the round ducts in any position by means of clamps. Installation in series is preferable to attain the better effect. To prevent the flexible silencer sagging it should be fixed not only at the ends but in the middle as well.

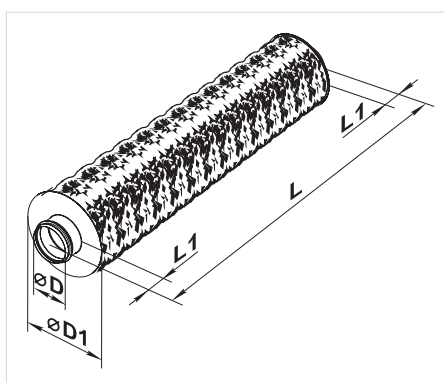

Designation key

Series	Air duct diameter [mm]	Length
SRP SRN	100; 125; 150; 160; 200; 250; 315	500; 600; 750; 900; 1200; 1500; 2000

Overall dimensions

Type	Dimensions [mm]				Mass [kg]
	ØD	ØD1	L	L1	
SRP 100/500	99	162	600	50	0.56
SRP 100/600	99	162	700	50	0.62
SRP 100/750	99	162	850	50	0.72
SRP 100/900	99	162	1000	50	0.82
SRP 100/1200	99	162	1300	50	1.02
SRP 100/1500	99	162	1600	50	1.22
SRP 100/2000	99	162	2100	50	1.55
SRP 120/500	119	187	600	50	0.59
SRP 120/600	119	187	700	50	0.65
SRP 120/750	119	187	850	50	0.75
SRP 120/900	119	187	1000	50	0.85
SRP 120/1200	119	187	1300	50	1.05
SRP 120/1500	119	187	1600	50	1.25
SRP 120/2000	119	187	2100	50	1.58
SRP 125/500	124	187	600	50	0.66
SRP 125/600	124	187	700	50	0.74
SRP 125/750	124	187	850	50	0.86
SRP 125/900	124	187	1000	50	0.97
SRP 125/1200	124	187	1300	50	1.21
SRP 125/1500	124	187	1600	50	1.44
SRP 125/2000	124	187	2100	50	1.83
SRP 150/500	149	212	600	50	0.91
SRP 150/600	149	212	700	50	1.00
SRP 150/750	149	212	850	50	1.14
SRP 150/900	149	212	1000	50	1.27
SRP 150/1200	149	212	1300	50	1.54
SRP 150/1500	149	212	1600	50	1.81
SRP 150/2000	149	212	2100	50	2.27
SRP 160/500	159	212	600	50	0.94
SRP 160/600	159	212	700	50	1.03
SRP 160/750	159	212	850	50	1.16
SRP 160/900	159	212	1000	50	1.30
SRP 160/1200	159	212	1300	50	1.57
SRP 160/1500	159	212	1600	50	1.84
SRP 160/2000	159	212	2100	50	2.29
SRP 200/500	199	264	600	50	1.25
SRP 200/600	199	264	700	50	1.36
SRP 200/750	199	264	850	50	1.53
SRP 200/900	199	264	1000	50	1.71
SRP 200/1200	199	264	1300	50	2.05
SRP 200/1500	199	264	1600	50	2.40
SRP 200/2000	199	264	2100	50	2.98
SRP 250/500	249	314	600	50	1.53
SRP 250/600	249	314	700	50	1.67
SRP 250/750	249	314	850	50	1.88
SRP 250/900	249	314	1000	50	2.09
SRP 250/1200	249	314	1300	50	2.51
SRP 250/1500	249	314	1600	50	2.93
SRP 250/2000	249	314	2100	50	3.63
SRP 315/500	314	365	600	50	1.87
SRP 315/600	314	365	700	50	2.04
SRP 315/750	314	365	850	50	2.30
SRP 315/900	314	365	1000	50	2.55
SRP 315/1200	314	365	1300	50	3.06
SRP 315/1500	314	365	1600	50	3.56
SRP 315/2000	314	365	2100	50	4.41

Overall dimensions

Type	Dimensions [mm]				Mass [kg]
	ØD	ØD1	L	L1	
SRN 100/500	99	162	600	50	0.56
SRN 100/600	99	162	700	50	0.62
SRN 100/750	99	162	850	50	0.72
SRN 100/900	99	162	1000	50	0.82
SRN 100/1200	99	162	1300	50	1.02
SRN 100/1500	99	162	1600	50	1.22
SRN 100/2000	99	162	2100	50	1.55
SRN 125/500	124	187	600	50	0.66
SRN 125/600	124	187	700	50	0.74
SRN 125/750	124	187	850	50	0.86
SRN 125/900	124	187	1000	50	0.97
SRN 125/1200	124	187	1300	50	1.21
SRN 125/1500	124	187	1600	50	1.44
SRN 125/2000	124	187	2100	50	1.83
SRN 150/500	149	212	600	50	0.91
SRN 150/600	149	212	700	50	1.00
SRN 150/750	149	212	850	50	1.14
SRN 150/900	149	212	1000	50	1.27
SRN 150/1200	149	212	1300	50	1.54
SRN 150/1500	149	212	1600	50	1.81
SRN 150/2000	149	212	2100	50	2.27
SRN 160/500	159	212	600	50	0.94
SRN 160/600	159	212	700	50	1.03
SRN 160/750	159	212	850	50	1.16
SRN 160/900	159	212	1000	50	1.30
SRN 160/1200	159	212	1300	50	1.57
SRN 160/1500	159	212	1600	50	1.84
SRN 160/2000	159	212	2100	50	2.29
SRN 200/500	199	264	600	50	1.25
SRN 200/600	199	264	700	50	1.36
SRN 200/750	199	264	850	50	1.53
SRN 200/900	199	264	1000	50	1.71
SRN 200/1200	199	264	1300	50	2.05
SRN 200/1500	199	264	1600	50	2.40
SRN 200/2000	199	264	2100	50	2.98
SRN 250/500	249	314	600	50	1.53
SRN 250/600	249	314	700	50	1.67
SRN 250/750	249	314	850	50	1.88
SRN 250/900	249	314	1000	50	2.09
SRN 250/1200	249	314	1300	50	2.51
SRN 250/1500	249	314	1600	50	2.93
SRN 250/2000	249	314	2100	50	3.63
SRN 315/500	314	365	600	50	1.87
SRN 315/600	314	365	700	50	2.04
SRN 315/750	314	365	850	50	2.30
SRN 315/900	314	365	1000	50	2.55
SRN 315/1200	314	365	1300	50	3.06
SRN 315/1500	314	365	1600	50	3.56
SRN 315/2000	314	365	2100	50	4.41

Series
SR

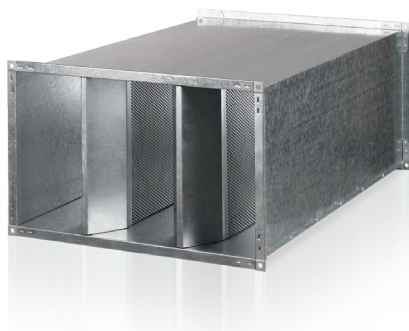

■ **Applications**

The plate silencer is applied for noise absorption produced during the ventilating equipment operation and spread along the ducting systems. Suitable for installation into rectangular ducts. The silencer reduces the noise level in the air duct significantly (refer the diagram «Noise level reduction»). The silencer is applied jointly with the sound-insulated fan in case of high noise

level requirements not only to the air duct but to the equipment in general.

■ **Design**

Silencer casing and plate shells are made of galvanized steel. The plates are filled with flameproof sound insulating material with protecting covering to prevent the fiber blowing-out.

■ **Mounting**

The mounting is performed by means of flange connection with respect to air flow direction (indicated with an arrow on the casing). The straight portion of at least 1 m long before the silencer is recommended to provide the peak efficiency. Installation in series is preferable to attain the better effect.

	Noise level reduction, dB (Octave-frequency band [Hz])							
	63 Hz	125 Hz	250 Hz	500 Hz	1000 Hz	2000 Hz	4000 Hz	8000 Hz
SR 400x200	3	7	10	23	27	30	25	22
SR 500x250	3	6	11	22	26	25	27	22
SR 500x300	3	6	10	23	24	25	23	18
SR 600x300	3	6	10	21	24	30	24	17
SR 600x350	3	5	11	22	25	29	24	21
SR 700x400	4	7	10	15	22	19	21	18
SR 800x500	5	6	11	17	21	20	22	20
SR 900x500	3	6	10	16	20	20	21	15
SR 1000x500	4	6	11	16	21	21	23	17

Designation key

Series	Flange dimensions (WxH) [mm]
SR	400x200; 500x250; 500x300; 600x300; 600x350; 700x400; 800x500; 900x500; 1000x500

Overall dimensions

Type	Dimensions [mm]							Mass [kg]
	B	B1	B2	H	H1	H2	L	
SR 400x200	400	420	440	200	220	240	950	18.5
SR 500x250	500	520	540	250	270	290	950	20.5
SR 500x300	500	520	540	300	320	340	950	24.5
SR 600x300	600	620	640	300	320	340	950	26.5
SR 600x350	600	620	640	350	370	390	950	28.7
SR 700x400	700	720	740	400	420	440	1010	36.7
SR 800x500	800	820	840	500	520	540	1010	50.0
SR 900x500	900	920	940	500	520	540	1010	51.7
SR 1000x500	1000	1020	1040	500	520	540	1010	57.3

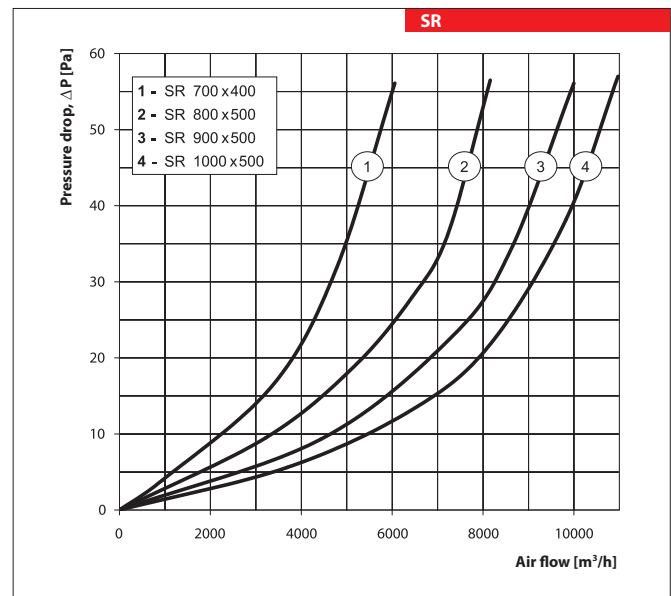
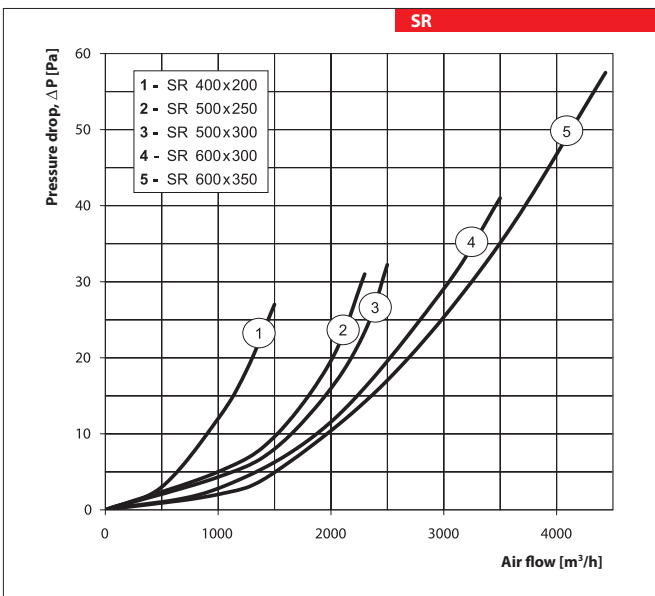
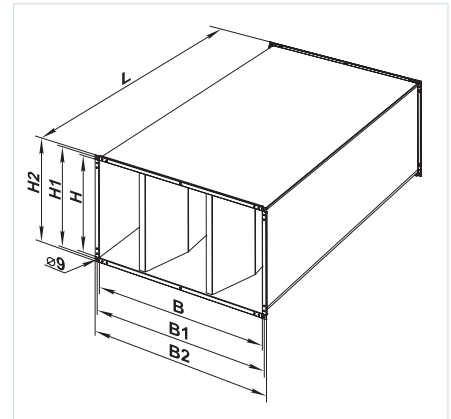

NKP Series



Heater for heat exchanger
freeze protection

Application

Duct electric heater for heat exchanger freeze protection by means of supply air preheating and supply air duct temperature maintaining at a point that ensures heat exchanger freezing protection.

Compatible with round Ø125, 150, 160, 200 and 250 mm air ducts.

Design

The casing and the control box are made of galvanized steel and the heating elements are made of stainless steel.

The heater casing is extra heat insulated with 20 mm non-flammable mineral wool layer.

The heater spigots are rubber sealed for airtight connection to the air ducts.

The NKP duct heaters are equipped with a power cable and a control cable for connection to a controller of an air handling unit.

Air temperature is controlled with a triac power controller that switches the maximum load on/off.

Load is commutated with a semiconductor (triac).

The heaters are equipped with overheat protection thermostats:

- ▶ self-resetting overheat protection thermostat actuated at +50 °C.
- ▶ emergency overheat protection thermostat actuated at +50 °C.

Mounting

The heater design ensures its connection to round air ducts by means of the clamps from the delivery set.

The arrow on the heater casing must match the air flow direction in the system.

The heater is connected to a controller of an air handling unit via the supplied cable with socket connectors.

The control box cover must be directed upwards with the maximum deviation angle 90°.

The control box cover must not be directed downwards.

Overall dimensions

Model	Dimensions [mm]				
	Ø D	B	H	L	L1
NKP 125-0,6-1	124	155	251	306	192
NKP 125-0,8-1					
NKP 125-1,2-1					
NKP 150-0,8-1	149	170	282	306	192
NKP 150-1,2-1					
NKP 150-1,7-1					
NKP 150-2,0-1					
NKP 160-0,8-1	159	175	293	306	192
NKP 160-1,2-1					
NKP 160-1,7-1					
NKP 160-2,0-1					
NKP 200-1,2-1	199	195	337	306	192
NKP 200-1,7-1					
NKP 200-2,0-1					
NKP 250-1,2-1	247	287	388	307	192
NKP 250-2,0-1					
NKP 250-3,0-1					

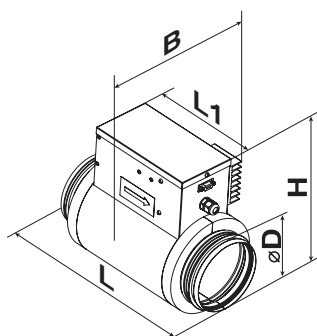

Designation key

Series	Connected air duct diameter [mm]	Heater power, kW	Phase
NKP	125; 150; 160; 200; 250	0.6; 0.8; 1.2; 1.7; 2.0; 3.0	1: single-phase

Technical data

Model	Min. air flow [m³/h]	Power [kW]	Current [A]
NKP 125-0,6-1	60	0.6	2.6
NKP 125-0,8-1	80	0.8	3.5
NKP 125-1,2-1	90	1.2	5.2
NKP 150-0,8-1	80	0.8	3.5
NKP 150-1,2-1	90	1.2	5.2
NKP 150-1,7-1	160	1.7	7.4
NKP 150-2,0-1	170	2.0	8.7
NKP 160-0,8-1	80	0.8	3.5
NKP 160-1,2-1	150	1.2	5.2
NKP 160-1,7-1	160	1.7	7.4
NKP 160-2,0-1	170	2.0	8.7
NKP 200-1,2-1	150	1.2	5.2
NKP 200-1,7-1	160	1.7	7.4
NKP 200-2,0-1	170	2.0	8.7
NKP 250-1,2-1	180	1.2	5.2
NKP 250-2,0-1	200	2.0	8.7
NKP 250-3,0-1	375	3.0	13.0

Compatibility table

Heater model (connected air duct diameter)	
NKP 125	VUT/VUE with Ø 125 mm spigot and A21 automation
NKP 150	VUT/VUE with Ø 150 mm spigot and A21 automation
NKP 160	VUT/VUE with Ø 160 mm spigot and A21 automation
NKP 200	VUT/VUE with Ø 200 mm spigot and A21 automation
NKP 250	VUT/VUE with Ø 250 mm spigot and A21 automation

Electric heater power selection diagram

Minimum temperature enabling efficient operation of the NKP freeze protection heater

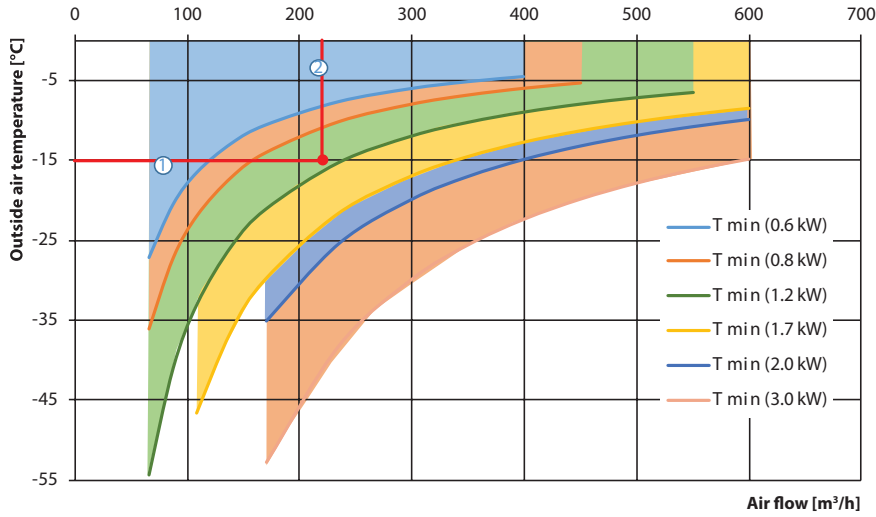

How to use NKP electric heater diagrams

- ▶ Selection of the NKP heater model compatible with VUT 350 VB EC A21 air handling unit. The rated winter outside air temperature is -15 °C. The rated air flow is 220 m³/h. Starting from the rated winter outside air temperature (1) draw a horizontal line till the air flow axis (2). The NKP heater with heating capacity 1200 W is able to provide efficient heat exchanger freeze protection.
- ▶ The NKP 160-1.2-1 with the diameter matching the spigot diameter of the VUT 350 VB EC A21 air handling unit is a suitable model.

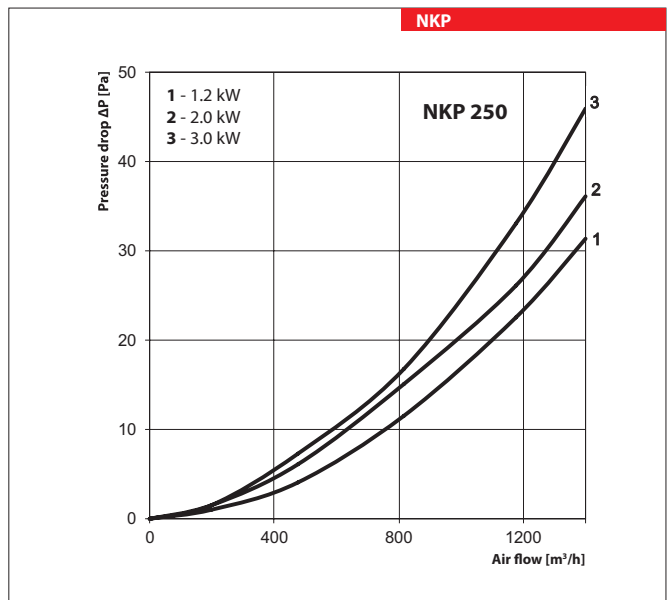
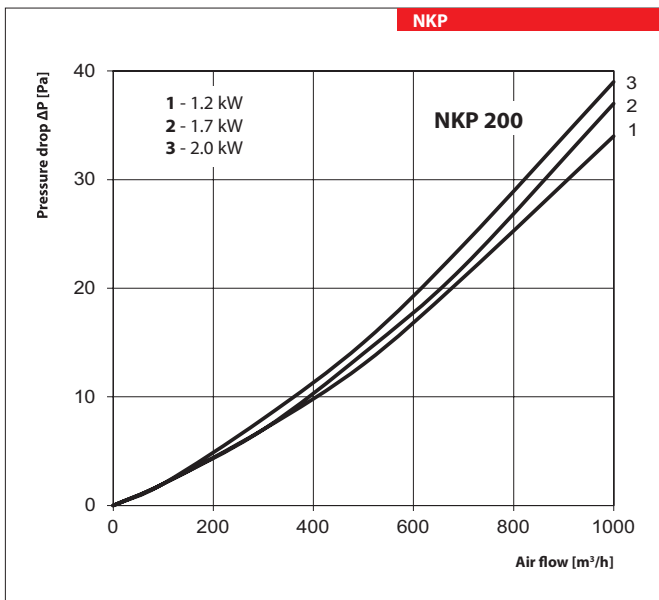
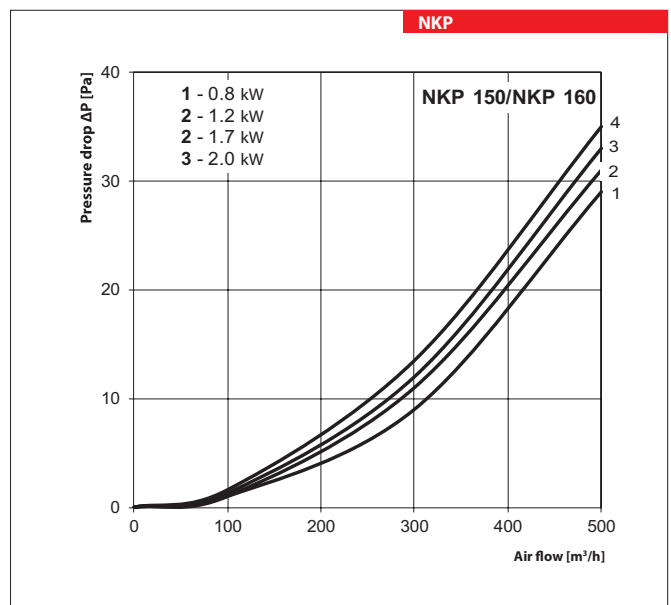
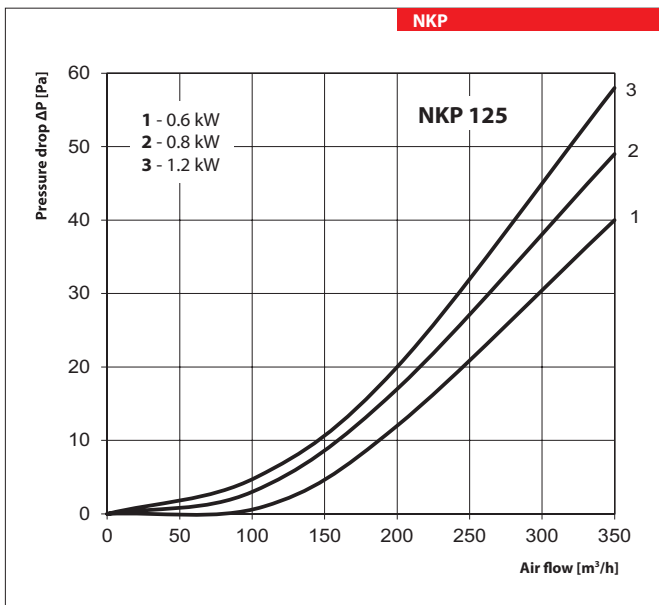

NKP A21 V.2

Series



Heater for heat exchanger
freeze protection

Application

Duct electric heater for heat exchanger freeze protection by means of supply air preheating and supply air duct temperature maintaining at a point that ensures heat exchanger freezing protection.

Compatible with round Ø125, 150, 160, 200, 250 and 315 mm air ducts.

Design

The casing and the control box are made of galvanized steel and the heating elements are made of stainless steel.

The heater casing is extra heat insulated with 20 mm non-flammable mineral wool layer.

The heater spigots are rubber sealed for airtight connection to the air ducts.

The NKP duct heaters are equipped with a power cable and a control cable for connection to a controller of an air handling unit.

Air temperature is controlled with a triac power controller that switches the maximum load on/off.

Load is commutated with a semiconductor (triac).

The heaters are equipped with overheat protection thermostats:

- ▶ self-resetting overheat protection thermostat actuated at +60 °C.
- ▶ emergency overheat protection thermostat actuated at +90 °C.

Mounting

The heater design ensures its connection to round air ducts by means of the clamps from the delivery set.

The arrow on the heater casing must match the air flow direction in the system.

The heater is controlled by the ventilation unit through the cable supplied and already connected to the heater at the factory.

The control box cover must be directed upwards with the maximum deviation angle 90°.

The control box cover must not be directed downwards.

Overall dimensions

Model	Dimensions [mm]				
	Ø D	B	H	L	L1
NKP 125-0,6-1	125	164	249	306	192
NKP 125-0,8-1					
NKP 125-1,2-1					
NKP 150-0,8-1	150	189	280	306	192
NKP 150-1,2-1					
NKP 150-1,7-1					
NKP 150-2,0-1					
NKP 160-0,8-1	160	197	291	306	192
NKP 160-1,2-1					
NKP 160-1,7-1					
NKP 160-2,0-1					
NKP 200-1,2-1	200	239	336	306	192
NKP 200-1,7-1					
NKP 200-2,0-1					
NKP 250-1,2-1	250	287	388	307	192
NKP 250-2,0-1					
NKP 250-3,0-1					
NKP 315-2,0-1	315	353	454	306	192
NKP 315-3,0-1					

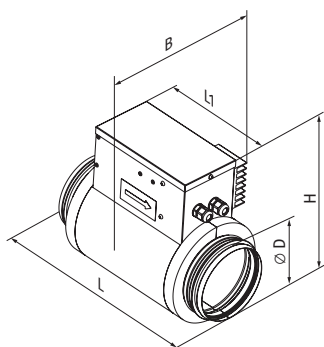

Designation key

Series	Connected air duct diameter [mm]	Heater power, kW	Phase	Options
NKP	125; 150; 160; 200; 250; 315	0.6; 0.8; 1.2; 1.7; 2.0; 3.0	1: single-phase	A21 V.2: compatible with A21 automation, without a DB-9M connector

Technical data

Model	Min. air flow [m³/h]	Power [kW]	Current [A]
NKP 125-0,6-1	60	0.6	2.6
NKP 125-0,8-1	80	0.8	3.5
NKP 125-1,2-1	90	1.2	5.2
NKP 150-0,8-1	80	0.8	3.5
NKP 150-1,2-1	90	1.2	5.2
NKP 150-1,7-1	160	1.7	7.4
NKP 150-2,0-1	170	2.0	8.7
NKP 160-0,8-1	80	0.8	3.5
NKP 160-1,2-1	150	1.2	5.2
NKP 160-1,7-1	160	1.7	7.4
NKP 160-2,0-1	170	2.0	8.7
NKP 200-1,2-1	150	1.2	5.2
NKP 200-1,7-1	160	1.7	7.4
NKP 200-2,0-1	170	2.0	8.7
NKP 250-1,2-1	180	1.2	5.2
NKP 250-2,0-1	200	2.0	8.7
NKP 250-3,0-1	375	3.0	13.0
NKP 315-2,0-1	220	2.0	8.7
NKP 315-3,0-1	320	3.0	13.0

Compatibility table

Heater model (connected air duct diameter)	
NKP 125 A21 V.2	VUT/VUEVB ECA21
NKP 150 A21 V.2	VUT/VUEVB ECA21
NKP 160 A21 V.2	VUT/VUEVB ECA21
NKP 200 A21 V.2	VUT/VUEVB ECA21
NKP 250 A21 V.2	VUT/VUEVB ECA21
NKP 315 A21 V.2	AirVents with a 315 mm spigot and an A21 automation

Electric heater power selection diagram

Minimum temperature enabling efficient operation of the NKP freeze protection heater

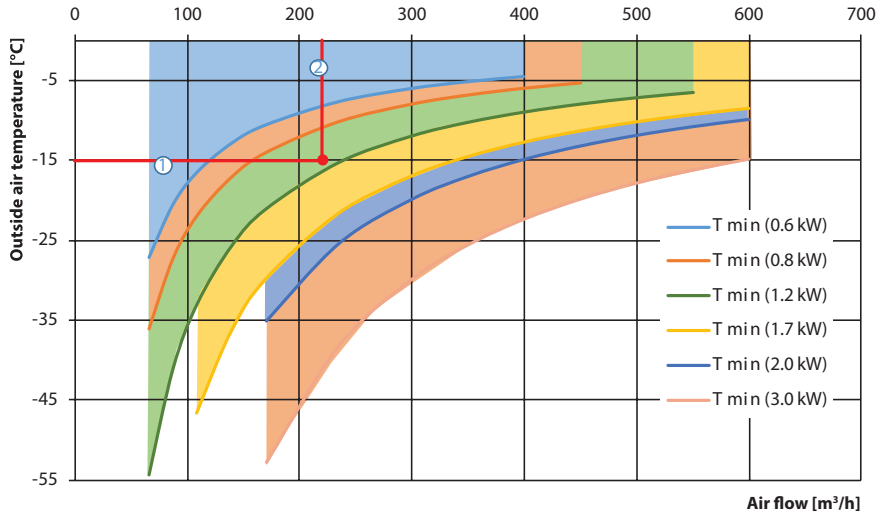

How to use NKP electric heater diagrams

- ▶ Selection of the NKP heater model compatible with VUT 350 VB EC A21 air handling unit. The rated winter outside air temperature is -15 °C. The rated air flow is 220 m³/h. Starting from the rated winter outside air temperature (1) draw a horizontal line till the air flow axis (2). The NKP heater with heating capacity 1200 W is able to provide efficient heat exchanger freeze protection.
- ▶ The NKP 160-1.2-1 with the diameter matching the spigot diameter of the VUT 350 VB EC A21 air handling unit is a suitable model.

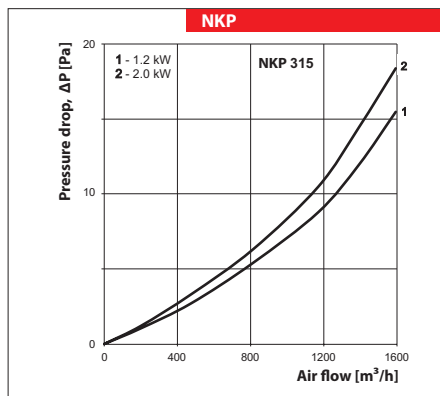
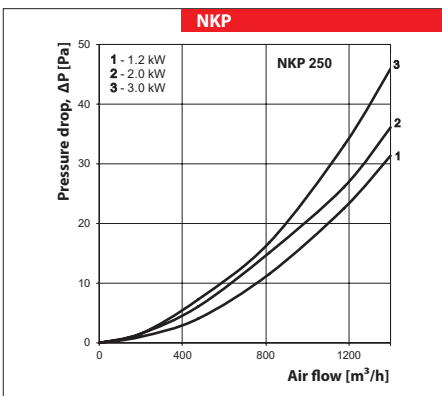
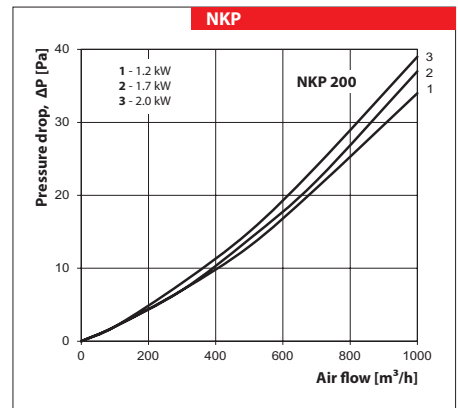
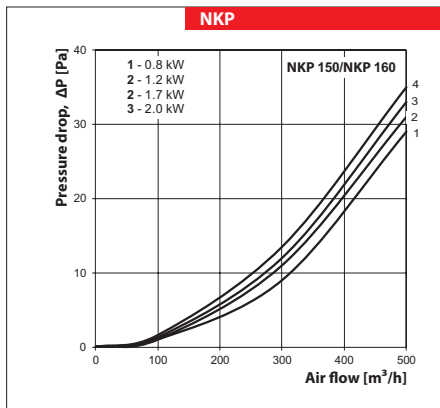
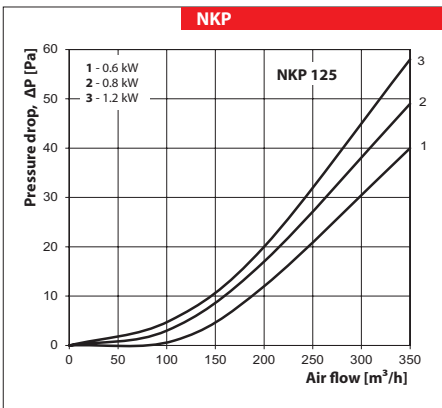

NKD Series



Duct heater for supply air post-heating with external control

Application

The heater is designed for integration into a ventilation system and joint operation with an air handling unit equipped with a control system used to switch on the heater and control its operation.

The heater maintains the supply duct air temperature at a point set by the unit controller.

Design

The casing, the junction box and the heater cover are made of galvanized steel with the heating elements in stainless steel. The heater casing is additionally heat-insulated with 20 mm non-flammable mineral wool layer. The heaters are equipped with rubber seals for airtight connection to the air ducts.

The NKD duct heaters are equipped with a power and a signal cable for connection of the heater to the air handling unit controller.

The temperature is controlled by a triac power controller by means of switching the full load on and off.

Load commutation is carried out by the semiconductor device (triac).

The heaters are equipped with overheat thermostats:

- ▶ main overheat protection with automatic reset at +50 °C
- ▶ emergency overheat protection with manual reset at +90 °C

Mounting

The heater design ensures its mounting on the round ducts in any position by means of clamps (included in delivery).

The air flow direction shall match the direction of the arrow on the heater casing.

The heater is connected to the air handling unit controller using the cable with connectors.

In case of horizontal mounting the control box must be installed with the cover upwards.

Swivel range from the normal position up to max. 90°.

Do not install the control box with the cover downwards.

Overall dimensions of the units

Model	Dimensions [mm]				
	Ø D	B	H	L	L1
NKD 125-0,6-1	124	155	251	306	190
NKD 125-0,8-1					
NKD 125-1,2-1					
NKD 150-0,8-1	149	170	282	306	190
NKD 150-1,2-1					
NKD 150-1,7-1					
NKD 150-2,0-1					
NKD 160-0,8-1	159	175	293	306	190
NKD 160-1,2-1					
NKD 160-1,7-1					
NKD 160-2,0-1					
NKD 200-1,2-1	199	195	337	306	190
NKD 200-1,7-1					
NKD 200-2,0-1					
NKD 250-1,2-1	247	287	388	307	190
NKD 250-2,0-1					
NKD 250-3,0-1					

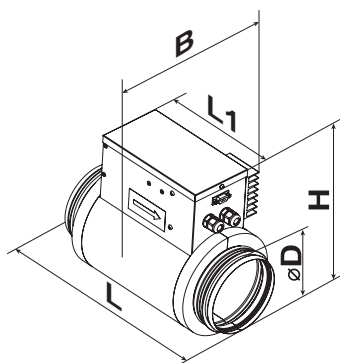

Technical data

Model	Min. air flow [m³/h]	Power [kW]	Current [A]
NKD 125-0,6-1	60	0.6	2.6
NKD 125-0,8-1	80	0.8	3.5
NKD 125-1,2-1	90	1.2	5.2
NKD 150-0,8-1	80	0.8	3.5
NKD 150-1,2-1	90	1.2	5.2
NKD 150-1,7-1	160	1.7	7.4
NKD 150-2,0-1	170	2.0	8.7
NKD 160-0,8-1	80	0.8	3.5
NKD 160-1,2-1	150	1.2	5.2
NKD 160-1,7-1	160	1.7	7.4
NKD 160-2,0-1	170	2.0	8.7
NKD 200-1,2-1	150	1.2	5.2
NKD 200-1,7-1	160	1.7	7.4
NKD 200-2,0-1	170	2.0	8.7
NKD 250-1,2-1	180	1.2	5.2
NKD 250-2,0-1	200	2.0	8.7
NKD 250-3,0-1	375	3.0	13.0

Compatibility table

Heater model (connected air duct diameter)	Automation
NKD 125 A21	VUT/VUE with Ø 125 mm spigot and A21 automation
NKD 150 A21	VUT/VUE with Ø 150 mm spigot and A21 automation
NKD 160 A21	VUT/VUE with Ø 160 mm spigot and A21 automation
NKD 200 A21	VUT/VUE with Ø 200 mm spigot and A21 automation
NKD 250 A21	VUT/VUE with Ø 250 mm spigot and A21 automation

Designation key

Series	Connected air duct diameter [mm]	Heater power [kW]	Phases	Compatibility with automation
NKD	125; 150; 160; 200; 250	0.6; 0.8; 1.2; 1.7; 2.0; 3.0	1: single-phase	A21: compatible with A21 automation

Technical data

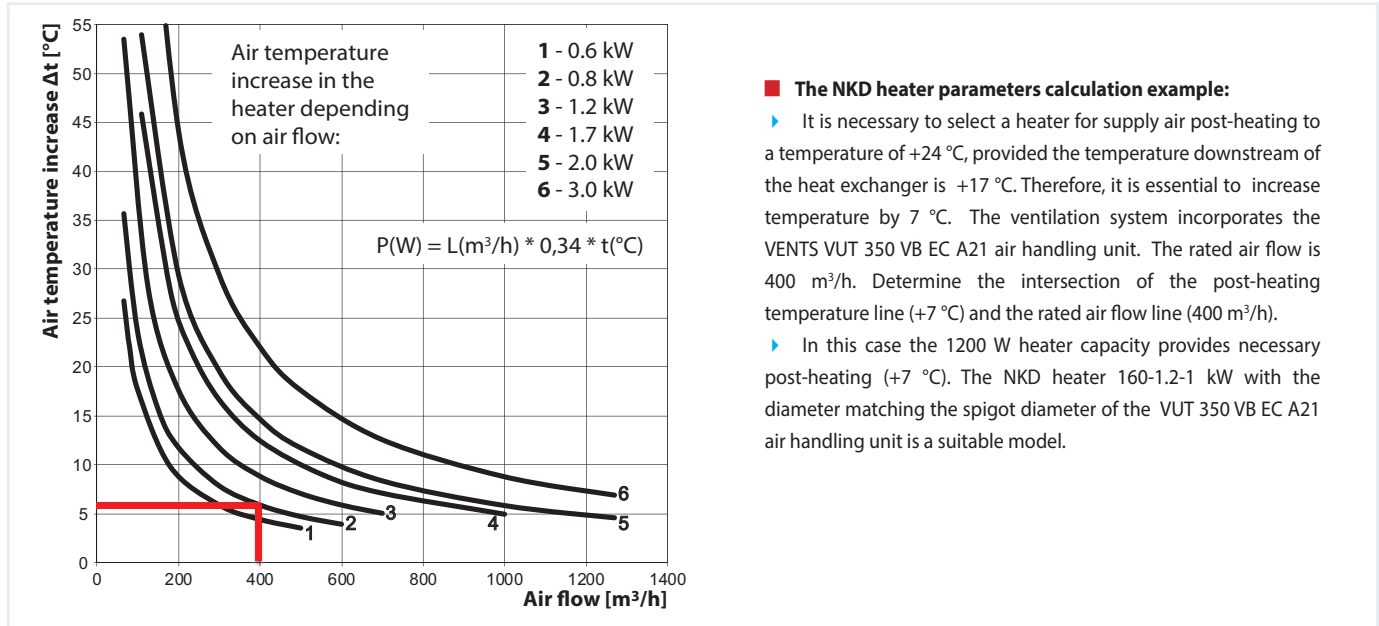

The NKD heater parameters calculation example:

- ▶ It is necessary to select a heater for supply air post-heating to a temperature of +24 °C, provided the temperature downstream of the heat exchanger is +17 °C. Therefore, it is essential to increase temperature by 7 °C. The ventilation system incorporates the VENTS VUT 350 VB EC A21 air handling unit. The rated air flow is 400 m³/h. Determine the intersection of the post-heating temperature line (+7 °C) and the rated air flow line (400 m³/h).
- ▶ In this case the 1200 W heater capacity provides necessary post-heating (+7 °C). The NKD heater 160-1.2-1 kW with the diameter matching the spigot diameter of the VUT 350 VB EC A21 air handling unit is a suitable model.

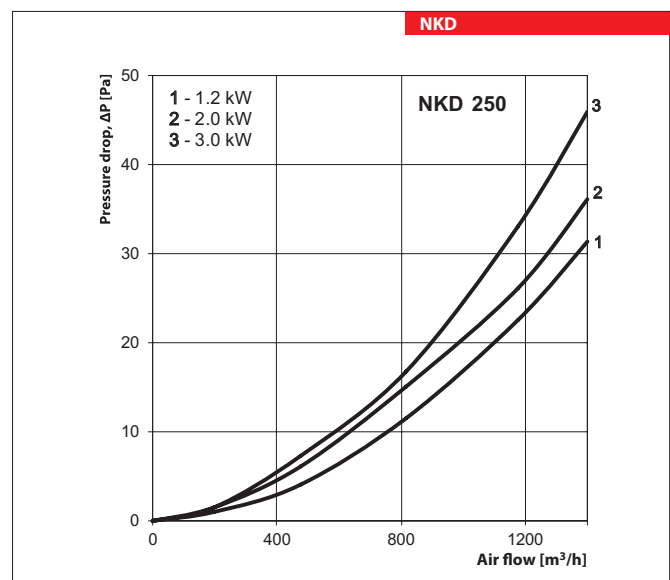
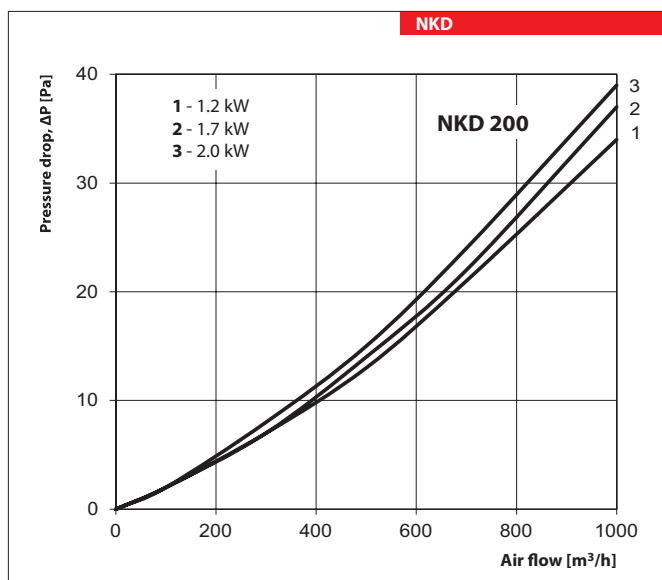
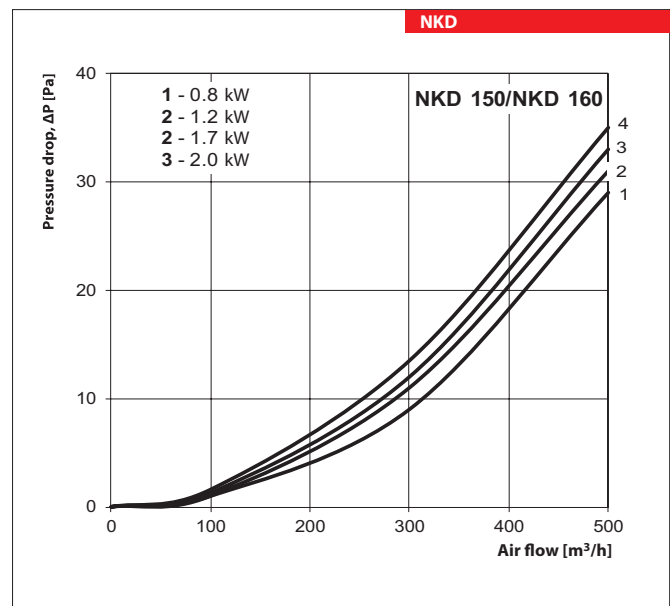
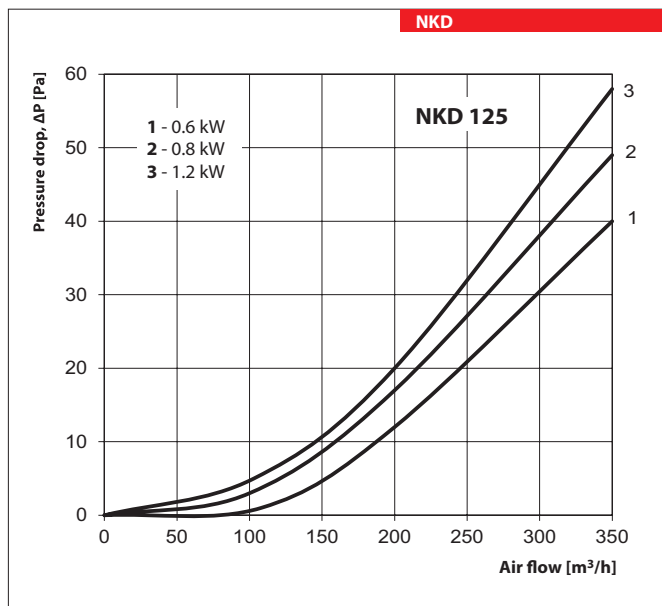

NKD A21 V.2

Series



Duct heater for supply air post-heating with external control

Application

The heater is designed for integration into a ventilation system and joint operation with an air handling unit equipped with a control system used to switch on the heater and control its operation.

The heater maintains the supply duct air temperature at a point set by the unit controller.

Design

The casing, the junction box and the heater cover are made of galvanized steel with the heating elements in stainless steel. The heater casing is additionally heat-insulated with 20 mm non-flammable mineral wool layer. The heaters are equipped with rubber seals for airtight connection to the air ducts.

NKD A21 V.2 duct heaters are equipped with a factory-wired power cable and a control cable, and also have a duct temperature sensor that is connected to the ventilation unit. Temperature control is carried out smoothly by the ventilation

unit controller due to the PWM signal in cycles of 10 seconds. Load commutation is carried out by the semiconductor device (triac).

The heaters are equipped with overheat thermostats:

- ▶ main overheat protection with automatic reset at +50 °C
- ▶ emergency overheat protection with manual reset at +90 °C

Mounting

The heater design ensures its mounting on the round ducts in any position by means of clamps (included in delivery).

The air flow direction shall match the direction of the arrow on the heater casing.

In case of horizontal mounting the control box must be installed with the cover upwards.

Swivel range from the normal position up to max. 90°.

Do not install the control box with the cover downwards.

Overall dimensions of the units

Model	Dimensions [mm]				
	Ø D	B	H	L	L1
NKD 125-0,6-1	125	164	249	306	192
NKD 125-0,8-1					
NKD 125-1,2-1					
NKD 150-0,8-1	150	189	280	306	192
NKD 150-1,2-1					
NKD 150-1,7-1					
NKD 150-2,0-1					
NKD 160-0,8-1					
NKD 160-1,2-1	160	197	291	306	192
NKD 160-1,7-1					
NKD 160-2,0-1					
NKD 200-1,2-1	200	239	336	306	192
NKD 200-1,7-1					
NKD 200-2,0-1					
NKD 250-1,2-1	250	287	388	307	192
NKD 250-2,0-1					
NKD 250-3,0-1					
NKD 315-2,0-1	315	353	454	306	192
NKD 315-3,0-1					

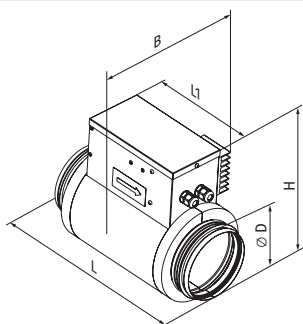

Designation key

Series	Connected air duct diameter [mm]	Heater power [kW]	Phases	Options
NKD	125; 150; 160; 200; 250; 315	0.6; 0.8; 1.2; 1.7; 2.0; 3.0	1: single-phase	A21 V.2: compatible with A21 automation, without a DB-9M connector

Technical data

Model	Min. air flow [m³/h]	Power [kW]	Current [A]
NKD 125-0,6-1	60	0.6	2.6
NKD 125-0,8-1	80	0.8	3.5
NKD 125-1,2-1	90	1.2	5.2
NKD 150-0,8-1	80	0.8	3.5
NKD 150-1,2-1	90	1.2	5.2
NKD 150-1,7-1	160	1.7	7.4
NKD 150-2,0-1	170	2.0	8.7
NKD 160-0,8-1	80	0.8	3.5
NKD 160-1,2-1	150	1.2	5.2
NKD 160-1,7-1	160	1.7	7.4
NKD 160-2,0-1	170	2.0	8.7
NKD 200-1,2-1	150	1.2	5.2
NKD 200-1,7-1	160	1.7	7.4
NKD 200-2,0-1	170	2.0	8.7
NKD 250-1,2-1	180	1.2	5.2
NKD 250-2,0-1	200	2.0	8.7
NKD 250-3,0-1	375	3.0	13.0
NKD 315-2,0-1	220	2.0	8.7
NKD 315-3,0-1	320	3.0	13.0

Compatibility table

Heater model (connected air duct diameter)	Options
NKD 125 A21 V.2	VUT/VUEVB ECA21
NKD 150 A21 V.2	VUT/VUEVB ECA21
NKD 160 A21 V.2	VUT/VUEVB ECA21
NKD 200 A21 V.2	VUT/VUEVB ECA21
NKD 250 A21 V.2	VUT/VUEVB ECA21
NKD 315 A21 V.2	AirVents with a 315 mm spigot and an A21 automation without a DB-9M connector

Technical data

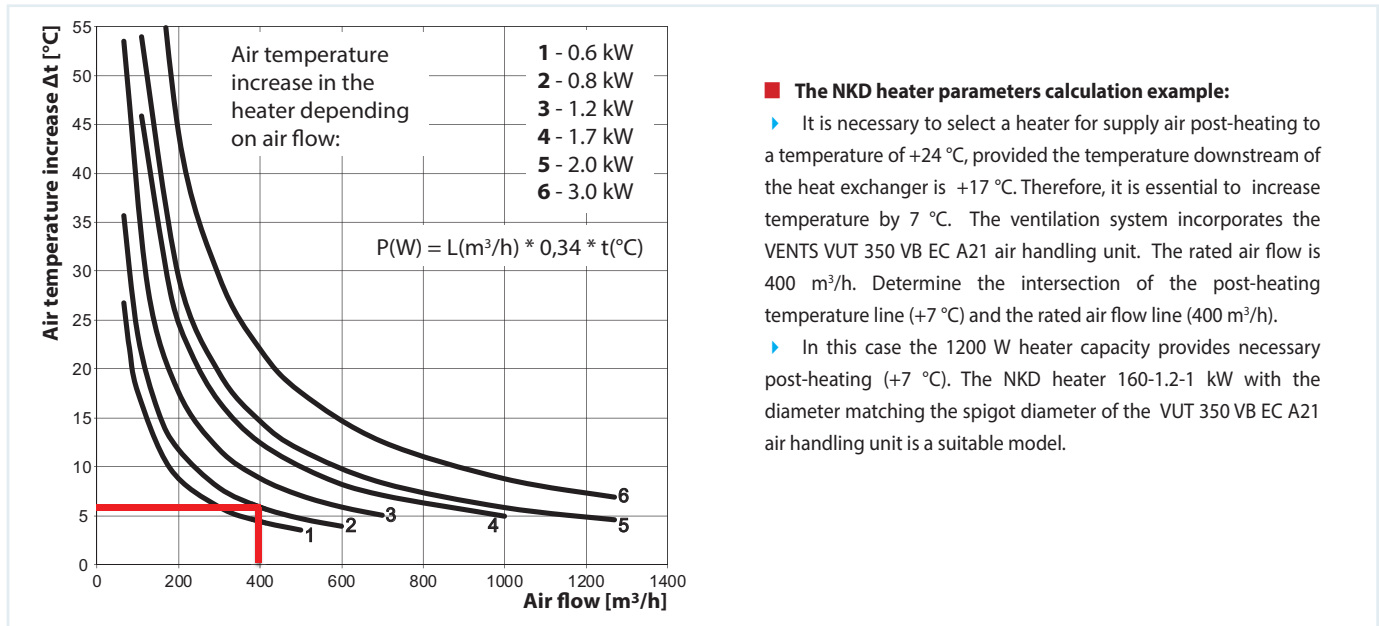

The NKD heater parameters calculation example:

- ▶ It is necessary to select a heater for supply air post-heating to a temperature of +24 °C, provided the temperature downstream of the heat exchanger is +17 °C. Therefore, it is essential to increase temperature by 7 °C. The ventilation system incorporates the VENTS VUT 350 VB EC A21 air handling unit. The rated air flow is 400 m³/h. Determine the intersection of the post-heating temperature line (+7 °C) and the rated air flow line (400 m³/h).
- ▶ In this case the 1200 W heater capacity provides necessary post-heating (+7 °C). The NKD heater 160-1.2-1 kW with the diameter matching the spigot diameter of the VUT 350 VB EC A21 air handling unit is a suitable model.

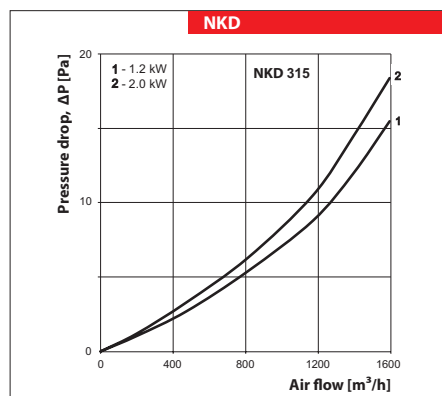
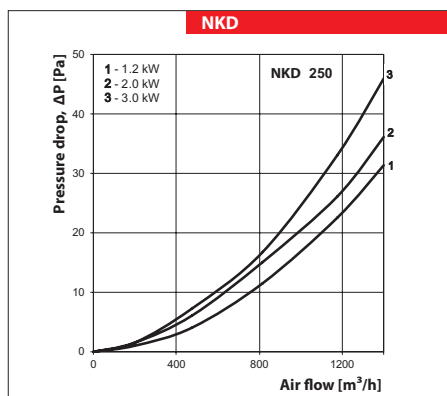
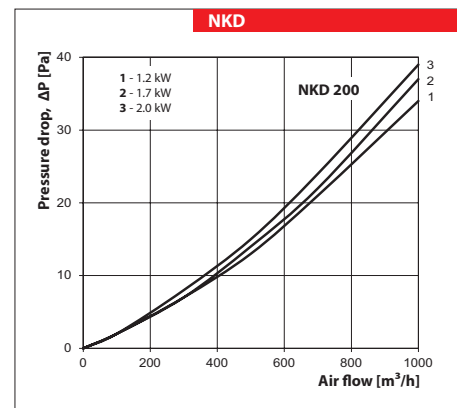
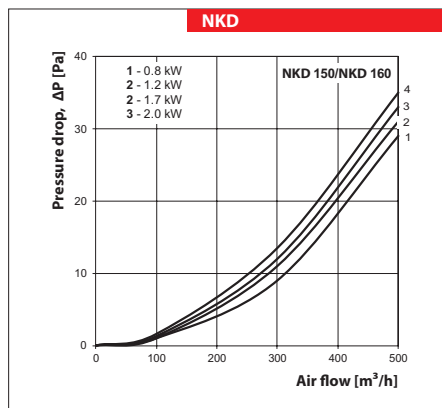
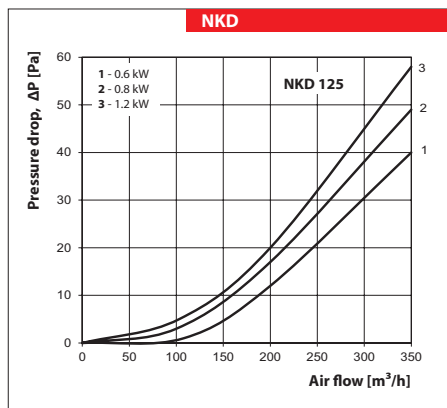

Series
NKV



■ **Applications**

Duct water heaters are designed for heating of supply air in round ventilation systems. They can be also applied in supply or supply and exhaust ventilating units.

■ **Design**

The heater casing is made of galvanized steel, the tubular coils are of copper tubes and the heat exchange surface is made of aluminium plates. The heaters are equipped with rubber seals for airtight connection to the air ducts. The heaters are available in 2 and 4 rows modifications and are designed for maximum operating pressure 1.6 MPa (16 bar) and maximum water operating temperature +100 °C. The outlet manifold has a branch pipe for installation of submersible temperature probe or icing protecting device. The heater is equipped with a nipple for the system deaeration.

■ **Mounting**

- ▶ The heater design ensures its mounting on the round ducts in any position by means of clamps. The water heating coils can be installed in any position that enables the heater deaeration. The air flow direction shall match the pointer designation on the heater.
- ▶ The mounting shall be performed in such a way as to enable the uniform air stream distribution along the whole cross section.
- ▶ The air filter shall be installed at the heater inlet to protect the heating elements against pollution.
- ▶ The heater can be installed at the fan inlet or outlet. If the heater is located at the filter outlet the air duct between the heater and the filter shall have the length of at least two connecting diameters to ensure the air flow stabilization as well as permissible air temperature level inside the fan.
- ▶ The heater shall be connected on the counter-flow basis, otherwise its efficiency can drop by 5-15 %. All the

nomographic charts in the catalogue are valid for such connection.

- ▶ If water serves as a heat medium the heaters are suitable for indoor installation only. For outdoor installation use antifreeze mixture, i.e. ethylene glycol solution.
- ▶ To ensure the correct and safe heater operation use the automation system that provides complex control and freezing protection:
 - ✓ automatic control of the heating capacity and air heating temperature;
 - ✓ switching ventilating system on after preliminary heating with the heater;
 - ✓ use of air curtains equipped with spring-loaded actuator;
 - ✓ filter checking by means of differential pressure sensor;
 - ✓ fan shutdown in case of the heater freezing danger.

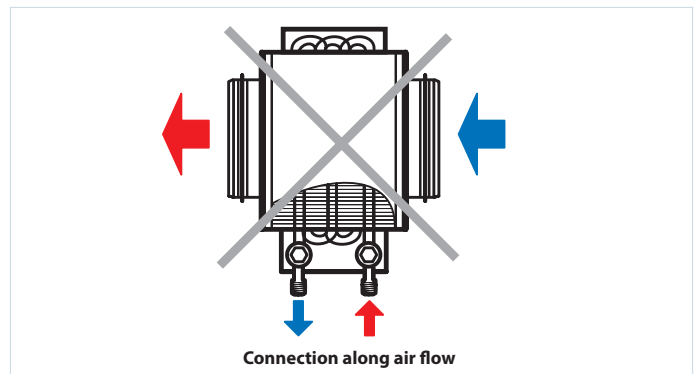
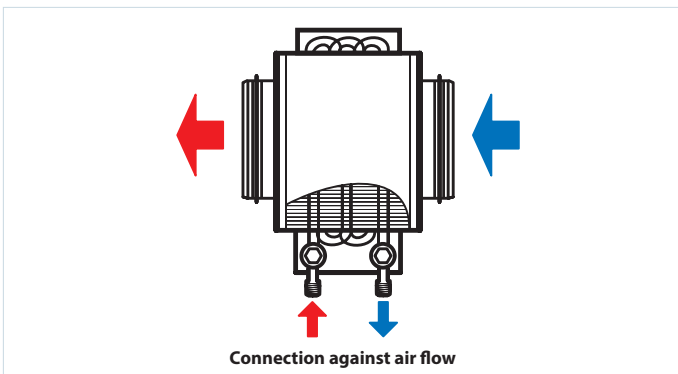

Designation key

Series	Flange diameter [mm]	-	Number of water coil rows
NKV	100; 125; 150; 160; 200; 250; 315		2; 4

Accessories



page 424

Overall dimensions

Type	Dimensions [mm]									Number of water coil rows	Mass [kg]
	∅D	B	H	H3	L	L1	L2	L3	K		
NKV 100-2	99	350	230	150	300	32	43	220	G 3/4"	2	3.9
NKV 100-4	99	350	230	150	300	28	65	220	G 3/4"	4	5.2
NKV 125-2	124	350	230	150	300	32	43	220	G 3/4"	2	4.0
NKV 125-4	124	350	230	150	300	28	65	220	G 3/4"	4	5.3
NKV 150-2	149	400	280	200	300	32	43	220	G 3/4"	2	7.5
NKV 150-4	149	400	280	200	300	28	65	220	G 3/4"	4	8.2
NKV 160-2	159	400	280	200	300	32	43	220	G 3/4"	2	7.5
NKV 160-4	159	400	280	200	300	28	65	220	G 3/4"	4	8.2
NKV 200-2	198	400	280	200	300	32	43	220	G 3/4"	2	7.5
NKV 200-4	198	400	280	200	300	28	65	220	G 3/4"	4	8.2
NKV 250-2	248	470	350	270	350	32	43	270	G 1"	2	10.3
NKV 250-4	248	470	350	270	350	28	65	270	G 1"	4	10.8
NKV 315-2	313	550	430	350	450	57	43	370	G 1"	2	12.6
NKV 315-4	313	550	430	350	450	53	65	370	G 1"	4	13.4

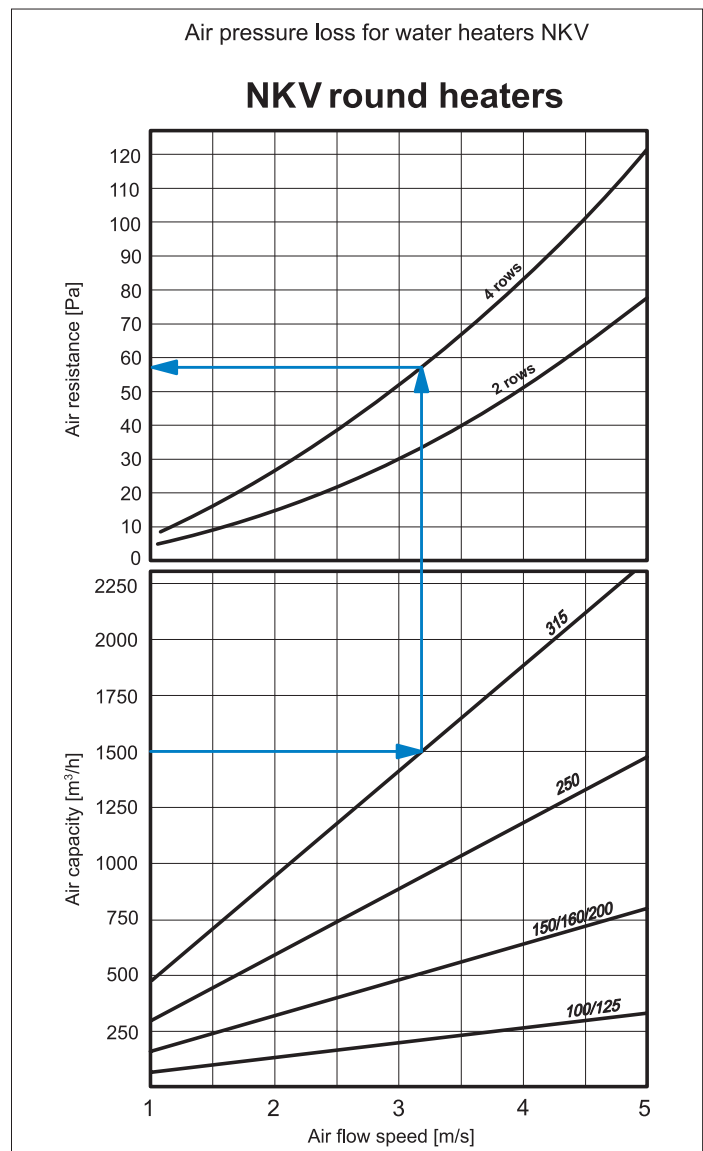
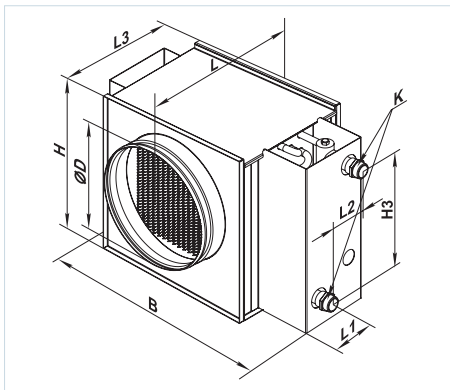

NKV

Air temperature after heater [°C]
5 10 15 20 25 30 35 40 45 50 55

NKV 100-2 / NKV 125-2

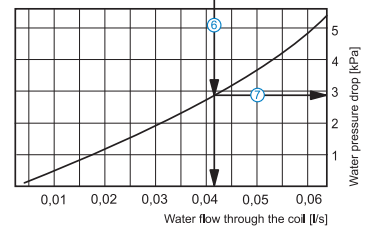
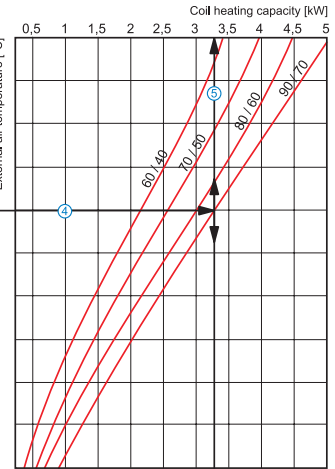
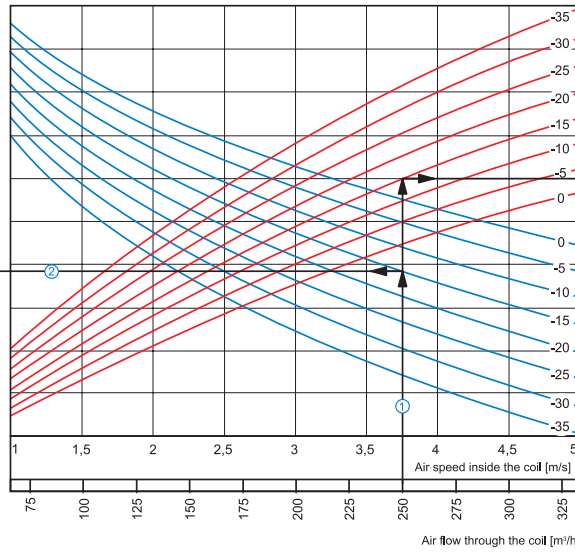
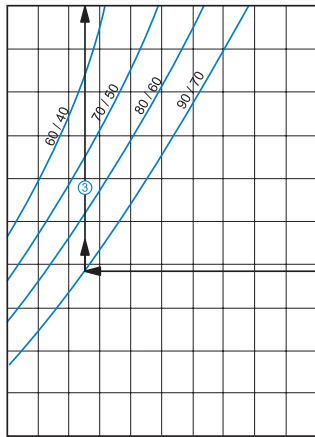

How to use water heater diagrams

Air Speed. Starting from 250 m³/h on the air flow scale draw a vertical line ① till the air speed axis which makes about 3.75 m/s.

Supply air temperature. Prolong the line ① up to the point where it crosses the outside air temperature (blue curve), e.g. -15 °C; then draw a horizontal line ② from this point to the left till crossing water in/out temperature curve (90/70 °C). From this point draw a vertical line ③ to the supply air temperature axis on top of the graphic (+17,5 °C).

Heating coil capacity. Prolong the line ① up to the point where it crosses the outside air temperature -15 °C (red curve) and draw a horizontal line ④ from this point to the right until it crosses water in/out temperature curve (90/70 °C), from here draw a vertical line ⑤ up to the scale representing the heating coil capacity (3.25 kW).

Water flow. Prolong the line ⑤ down to water flow axis at the bottom of the graphic ⑥ (0.042 l/s).

Water pressure drop. Draw the line ⑦ from the point where line ⑥ crosses the black curve to the pressure drop axis. (2.9 kPa).

NKV

Air temperature after heater [°C]
15 20 25 30 35 40 45 50 55 60 65

NKV 100-4 / NKV 125-4

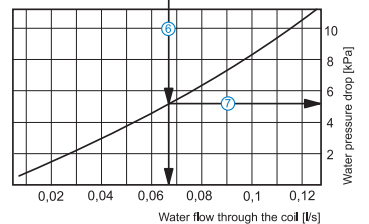
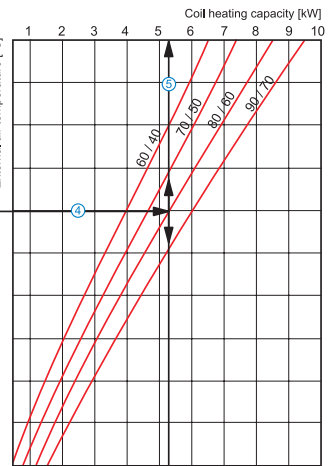
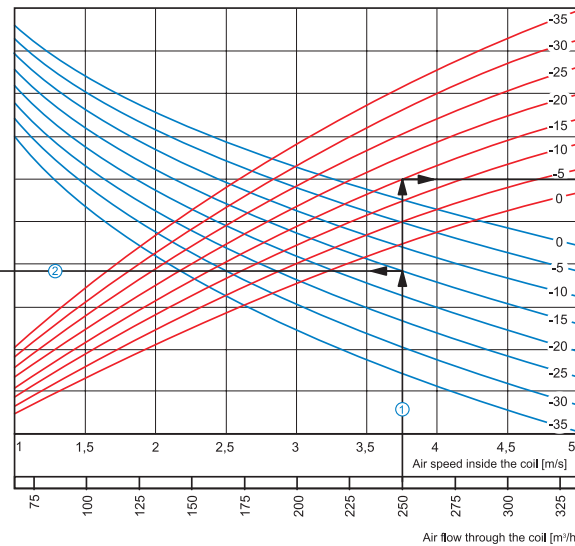
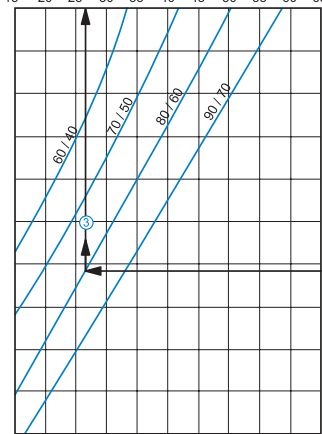

How to use water heater diagrams

Air Speed. Starting from 250 m³/h on the air flow scale draw a vertical line ① till the air speed axis which makes about 3.75 m/s.

Supply air temperature. Prolong the line ① up to the point where it crosses the outside air temperature (blue curve), e.g. -15 °C; then draw a horizontal line ② from this point to the left till crossing water in/out temperature curve (80/60 °C). From this point draw a vertical line ③ to the supply air temperature axis on top of the graphic (+27 °C).

Heating coil capacity. Prolong the line ① up to the point where it crosses the outside air temperature indicated as red curve (e.g., -15 °C) and draw a horizontal line ④ from this point to the right to the intersection of water in/out temperature curve (e.g., 80/60 °C). From this point draw a vertical line ⑤ up to the scale of heating coil capacity (5.2 kW).

Water flow. Prolong the line ⑤ down to water flow axis at the bottom of the graphic ⑥ (0.067 l/s).

Water pressure drop. Draw the line ⑦ from the point where line ⑥ crosses the black curve to the pressure drop axis. (5.2 kPa).

NKV

NKV 150-2 / NKV 160-2 / NKV 200-2

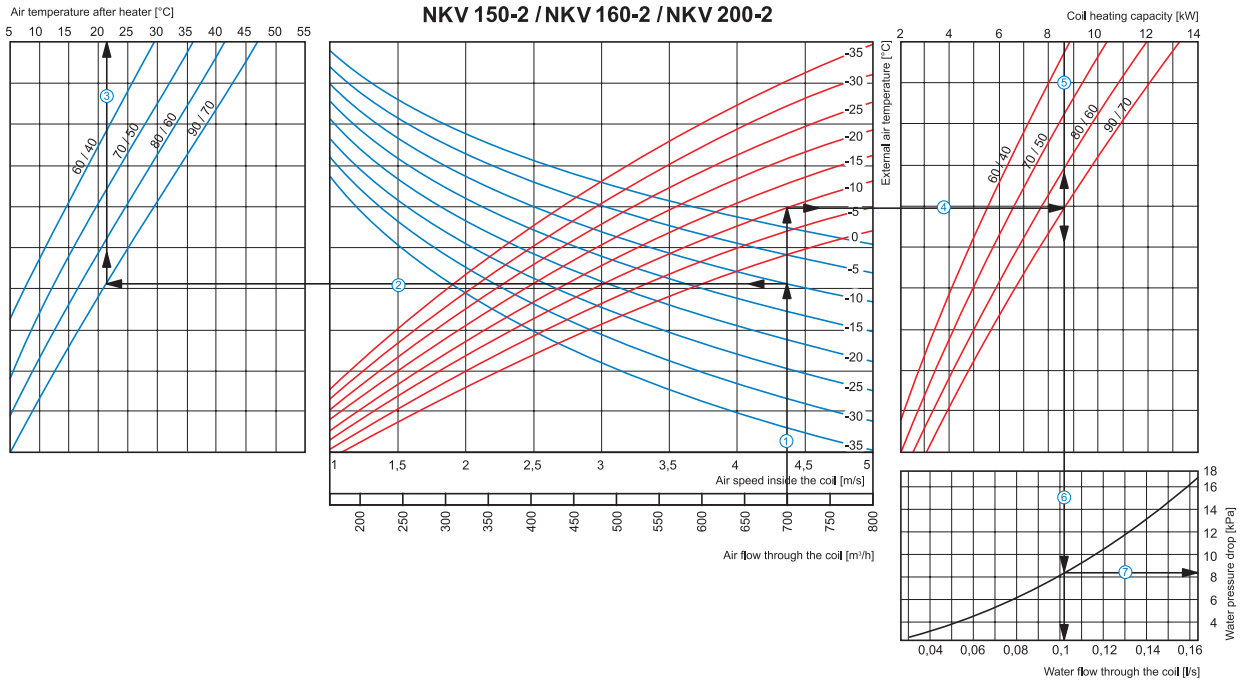

How to use water heater diagrams

- Air Speed. Starting from 700 m³/h on the air flow scale draw a vertical line ① till the air speed axis which makes about 4.4 m/s.
- Supply air temperature. Prolong the line ① up to the point where it crosses the outside air temperature (blue curve), e.g. -10 °C; then draw a horizontal line ② from this point to the left till crossing water in/out temperature curve (90/70 °C). From this point draw a vertical line ③ to the supply air temperature axis on top of the graphic (+21 °C).
 - Heating coil capacity. Prolong the line ① up to the point where it crosses the outside air temperature indicated as red curve (e.g., -10 °C) and draw a horizontal line ④ from this point to the right to the intersection of water in/out temperature curve (e.g., 90/70 °C). From this point draw a vertical line ⑤ up to the scale of heating coil capacity (8.6 kW).
 - Water flow. Prolong the line ⑥ down to water flow axis at the bottom of the graphic (0.11 l/s).
 - Water pressure drop. Draw the line ⑦ from the point where line ⑥ crosses the black curve to the pressure drop axis. (8.2 kPa).

NKV

NKV 150-4 / NKV 160-4 / NKV 200-4

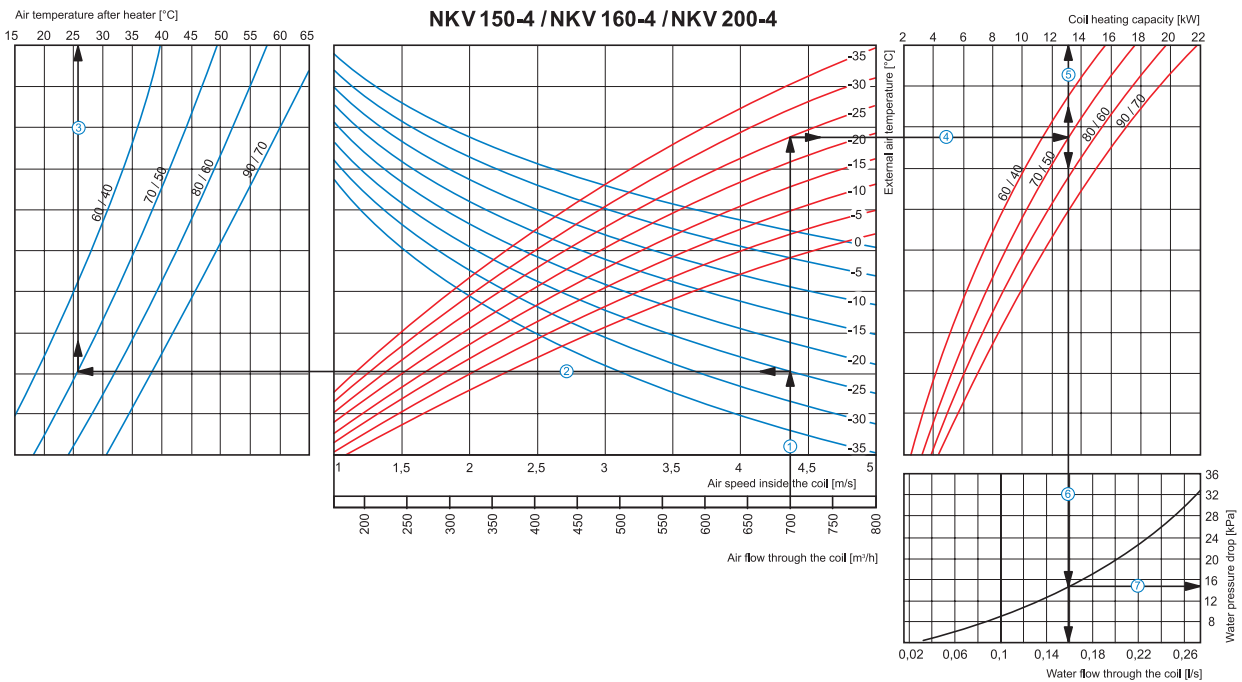

How to use water heater diagrams

- Air Speed. Starting from 700 m³/h on the air flow scale draw a vertical line ① till the air speed axis which makes about 4.4 m/s.
- Supply air temperature. Prolong the line ① up to the point where it crosses the outside air temperature (blue curve), e.g. -25 °C; then draw a horizontal line ② from this point to the left till crossing water in/out temperature curve (70/50 °C). From this point draw a vertical line ③ to the supply air temperature axis on top of the graphic (+26 °C).
 - Heating coil capacity. Prolong the line ① up to the point where it crosses the outside air temperature indicated as red curve (e.g., -25 °C) and draw a horizontal line ④ from this point to the right to the intersection of water in/out temperature curve (e.g., 70/50 °C). From this point draw a vertical line ⑤ up to the scale of heating coil capacity (13.0 kW).
 - Water flow. Prolong the line ⑥ down to water flow axis at the bottom of the graphic (0.16 l/s).
 - Water pressure drop. Draw the line ⑦ from the point where line ⑥ crosses the black curve to the pressure drop axis. (15 kPa).

NKV

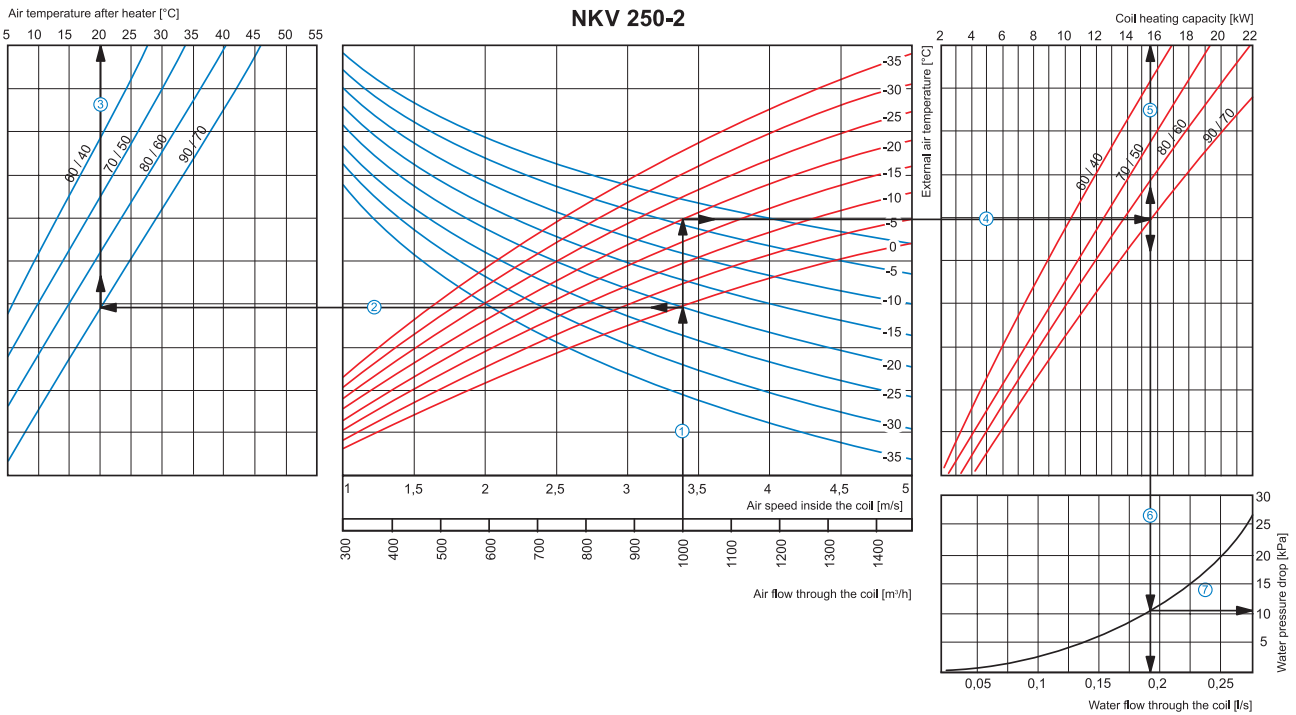

How to use water heater diagrams

- Air Speed. Starting from 1000 m³/h on the air flow scale draw a vertical line ① till the air speed axis which makes about 3.4 m/s.
- Supply air temperature. Prolong the line ① up to the point where it crosses the outside air temperature (blue curve), e.g. -20 °C; then draw a horizontal line ② from this point to the left till crossing water in/out temperature curve (90/70 °C). From this point draw a vertical line ③ to the supply air temperature axis on top of the graphic (+20 °C).
- Heating coil capacity. Prolong the line ① up to the point where it crosses the outside air temperature indicated as red curve (e.g., -20 °C) and draw a horizontal line ④ from this point to the right to the intersection of water in/out temperature curve (e.g., 90/70 °C). From this point draw a vertical line ⑤ up to the scale of heating coil capacity (15.5 kW).
- Water flow. Prolong the line ⑤ down to water flow axis at the bottom of the graphic ⑥ (0.19 l/s).
- Water pressure drop. Draw the line ⑦ from the point where line ⑥ crosses the black curve to the pressure drop axis. (11.0 kPa)

NKV

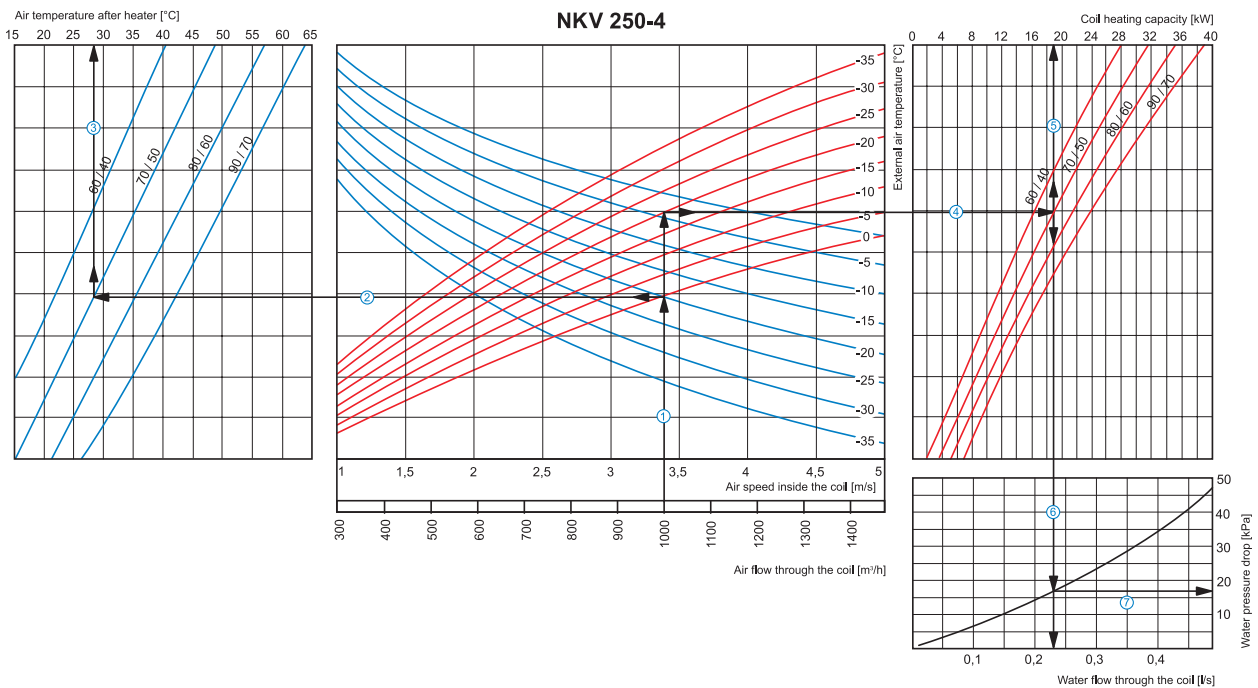

How to use water heater diagrams

- Air Speed. Starting from 1000 m³/h on the air flow scale draw a vertical line ① till the air speed axis which makes about 3.4 m/s.
- Supply air temperature. Prolong the line ① up to the point where it crosses the outside air temperature (blue curve), e.g. -20 °C; then draw a horizontal line ② from this point to the left till crossing water in/out temperature curve (70/50 °C). From this point draw a vertical line ③ to the supply air temperature axis on top of the graphic (+28 °C).
- Heating coil capacity. Prolong the line ① up to the point where it crosses the outside air temperature indicated as red curve (e.g., -20 °C) and draw a horizontal line ④ from this point to the right to the intersection of water in/out temperature curve (e.g., 70/50 °C). From this point draw a vertical line ⑤ up to the scale of heating coil capacity (19.0 kW).
- Water flow. Prolong the line ⑤ down to water flow axis at the bottom of the graphic ⑥ (0.23 l/s).
- Water pressure drop. Draw the line ⑦ from the point where line ⑥ crosses the black curve to the pressure drop axis. (17.0 kPa).

NKV

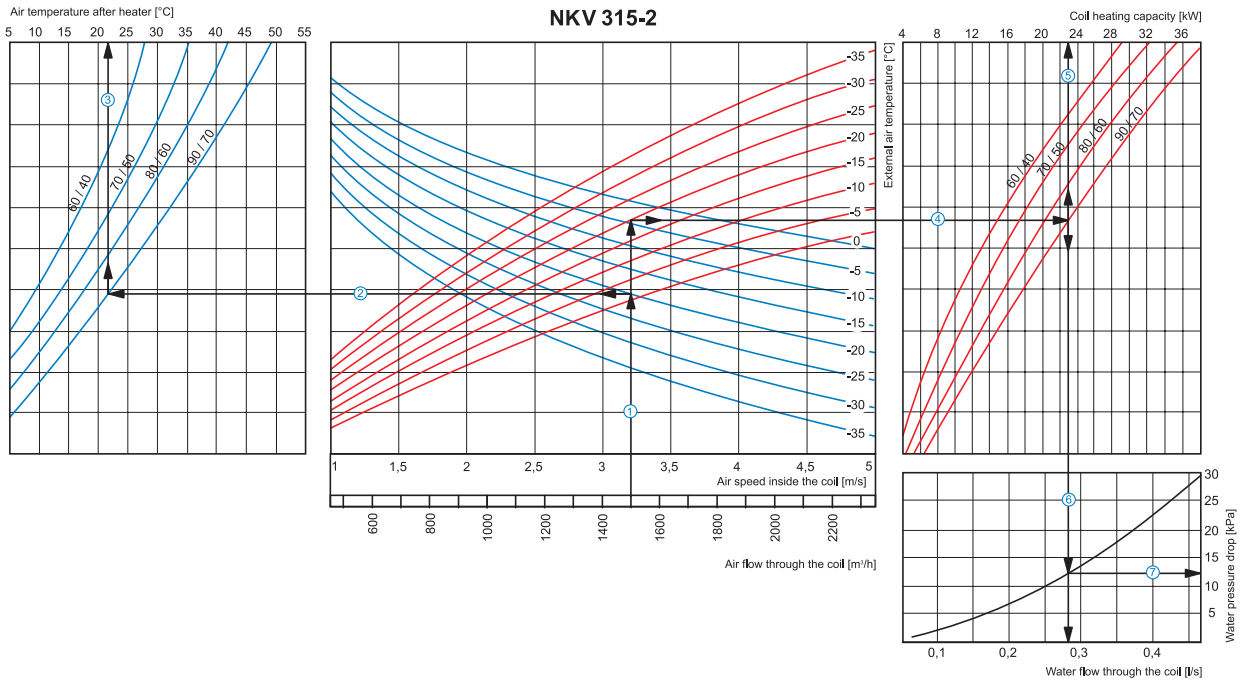

How to use water heater diagrams

Air Speed. Starting from 1500 m³/h on the air flow scale draw a vertical line ① till the air speed axis which makes about 3.2 m/s.

- Supply air temperature. Prolong the line ① up to the point where it crosses the outside air temperature (blue curve), e.g. -20 °C; then draw a horizontal line ② from this point to the left till crossing water in/out temperature curve (90/70 °C). From this point draw a vertical line ③ to the supply air temperature axis on top of the graphic (+21 °C).
- Heating coil capacity. Prolong the line ① up to the point where it crosses the outside air temperature (e.g. -20 °C, red curve) and draw a horizontal line ④ from this point to the right until it crosses water in/out temperature curve (e.g. 90/70 °C), from here draw a vertical line ⑤ up to the scale representing the heating coil capacity (23.0 kW).
- Water flow. Prolong the line ⑤ down to water flow axis at the bottom of the graphic ⑥ (0.28 l/s)
- Water pressure drop. Draw the line ⑦ from the point where line ⑥ crosses the black curve to the pressure drop axis. (12.5 kPa).

NKV

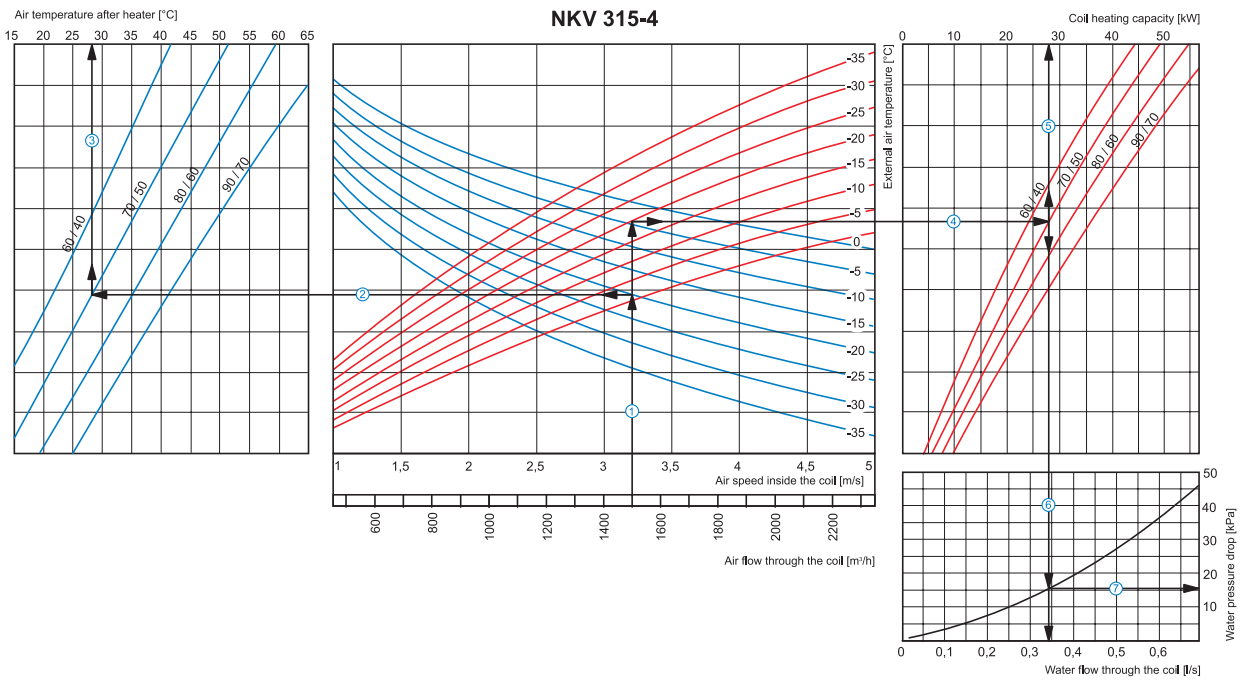

How to use water heater diagrams

Air Speed. Starting from 1500 m³/h on the air flow scale draw a vertical line ① till the air speed axis which makes about 3.2 m/s.

- Supply air temperature. Prolong the line ① up to the point where it crosses the outside air temperature (blue curve), e.g. -20 °C; then draw a horizontal line ② from this point to the left till crossing water in/out temperature curve (70/50 °C). From this point draw a vertical line ③ to the supply air temperature axis on top of the graphic (+28 °C).
- Heating coil capacity. Prolong the line ① up to the point where it crosses the outside air temperature (e.g. -20 °C, red curve) and draw a horizontal line ④ from this point to the right until it crosses water in/out temperature curve (e.g. 70/50 °C), from here draw a vertical line ⑤ up to the scale representing the heating coil capacity (28.0 kW).
- Water flow. Prolong the line ⑤ down to water flow axis at the bottom of the graphic ⑥ (0.34 l/s)
- Water pressure drop. Draw the line ⑦ from the point where line ⑥ crosses the black curve to the pressure drop axis. (16.0 kPa).

Series
OKW



Series
OKW1



■ **Applications**

Duct water coil air coolers are designed for cooling of supply air in rectangular ventilation systems and can be applied in supply or supply and exhaust ventilation systems.

■ **Design**

The water coolers are available in OKW and OKW1 modifications. The OKW1 cooler has a simplified design. The cooler casing is made of galvanized steel, the manifold is made of copper tubes and the heat exchange surface is made of aluminium plates. The cooling coils are available in 3 rows modification and designed for the maximum operating pressure 1.5 MPa (15 bar). It is equipped with a droplet separator and a drain pan for condensate collection and removal. For OKW and OKW1 models by default the service side is located on the right side from the air stream direction. The OKW cooler service side location can be changed by coil turning by 180°. The OKW1 modification does not have this option.

■ **Mounting**

- ▶ Mounting is effected by means of flange connection. The water cooling coils can be installed only horizontally to enable the unit deaeration and condensate draining.
- ▶ The installation shall be performed in such a way as

to enable the uniform air distribution along the entire cross section.

- ▶ The air filter shall be installed at the cooler inlet to protect the cooler against dirt and dusting.
- ▶ The cooler can be installed both at the fan inlet or outlet. If the cooling coils are located at the fan outlet the air duct between the cooler and the fan shall have the length 1 to 1.5 m to ensure the air flow stabilization.
- ▶ To attain the maximum cooling capacity the cooler must be connected on counter-flow basis. All the nomographic charts in the catalogue are valid for such connection.
- ▶ If water serves as a cooling agent, the coolers are suitable for indoor installation only in the premises with the indoor temperature not below 0 °C. For outdoor

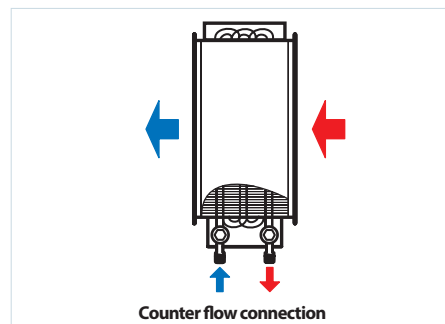

installation use an antifreeze mixture, i.e.ethylene glycol solution.

- ▶ The droplet separator is made of polypropylene profile and prevents condensate dripping from the cooling tubes by the cooling air flow. While selecting a cooler type consider that the most suitable speed of the air flow for the efficient droplet separator operation is up to 4 m/s.
- ▶ Condensate drain from the cooler shall be performed through the U-trap. The U-trap height depends on the total pressure in the fan and can be calculated using the figures and the table below.

H [mm]	K [mm]	P [Pa]
100	55	600
200	105	1100
260	140	1400

H - U-trap height
K - drain height
P - total pressure in the fan

- ▶ To ensure the correct and safe cooler operation use the automation system providing the complex control and automatic regulation of the cooling capacity and air cooling temperature.

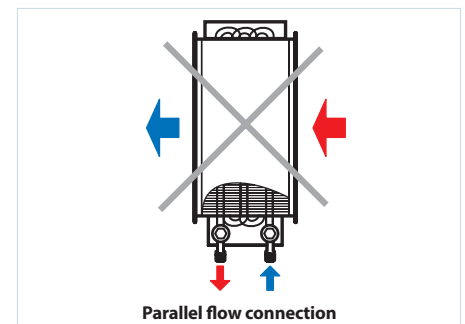

Designation key

Series	Flange dimensions (WxH) [mm]	Number of cooling coils
OKW/OKW1	400x200; 500x250; 500x300; 600x300; 600x350; 700x400; 800x500; 900x500; 1000x500	3

Accessories



Overall dimensions

Type	Dimensions [mm]										
	B	B1	B2	B3	H	H1	H2	H3	H4	L	K (inch)
OKW 400x200-3	400	420	440	470	200	220	240	295	124	56	G 3/4"
OKW 500x250-3	500	520	540	570	250	270	290	345	188	45	G 3/4"
OKW 500x300-3	500	520	540	570	300	320	340	395	252	56	G 3/4"
OKW 600x300-3	600	620	640	670	300	320	340	395	252	56	G 3/4"
OKW 600x350-3	600	620	640	670	350	370	390	445	268	56	G 3/4"
OKW 700x400-3	700	720	740	770	400	420	440	495	314	56	G 3/4"
OKW 800x500-3	800	820	840	870	500	520	540	595	442	56	G 3/4"
OKW 900x500-3	900	920	940	970	500	520	540	595	442	56	G 3/4"
OKW 1000x500-3	1000	1020	1040	1070	500	520	540	595	442	56	G 1"

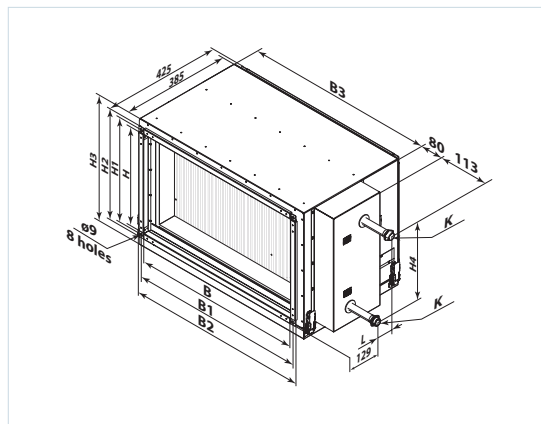

Overall dimensions

Type	Dimensions [mm]										
	B	B1	B2	H	H1	H2	H3	H4	L	K (inch)	
OKW1 400x200-3	400	420	580	200	220	270	124	70	56	G 3/4"	
OKW1 500x250-3	500	520	680	250	270	320	188	102	45	G 3/4"	
OKW1 500x300-3	500	520	680	300	320	370	252	70	56	G 3/4"	
OKW1 600x300-3	600	620	780	300	320	370	252	134	56	G 3/4"	
OKW1 600x350-3	600	620	780	350	370	420	268	229	56	G 3/4"	
OKW1 700x400-3	700	720	880	400	420	470	314	196	56	G 3/4"	
OKW1 800x500-3	800	820	980	500	520	570	442	324	56	G 3/4"	
OKW1 900x500-3	900	920	1080	500	520	570	442	324	56	G 3/4"	
OKW1 1000x500-3	1000	1020	1180	500	520	570	442	324	56	G 1"	

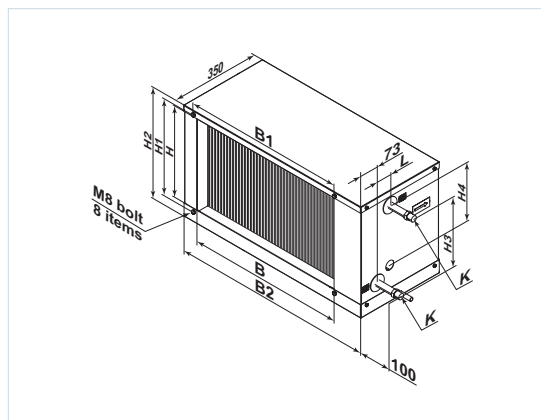

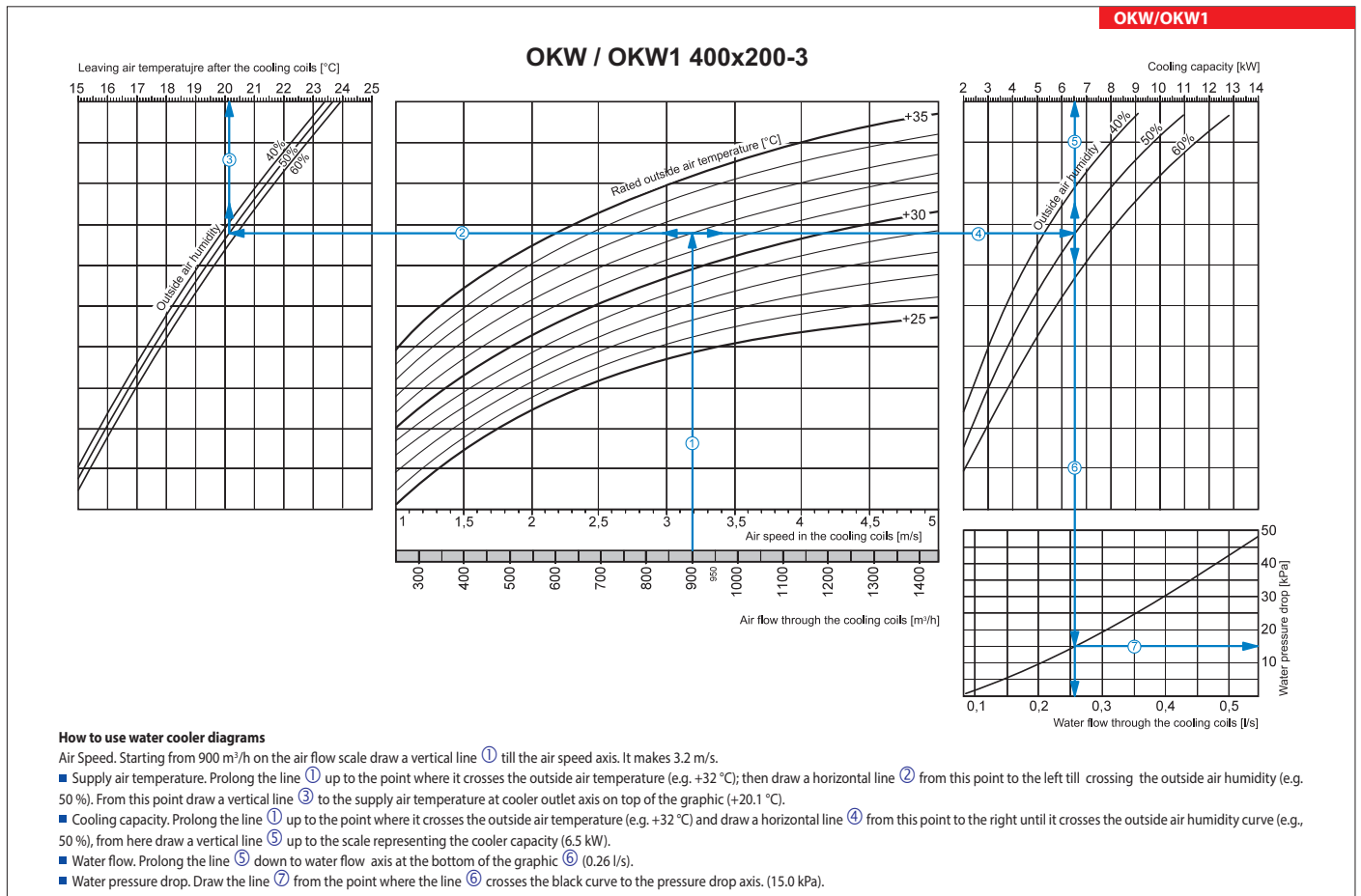
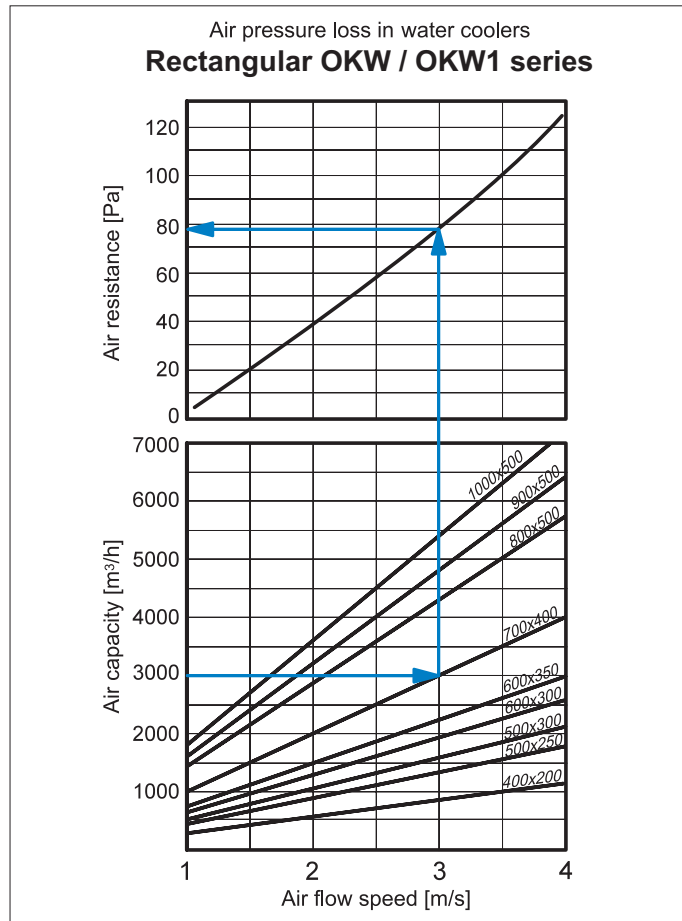

OKW/OKW1

OKW / OKW1 500x250-3

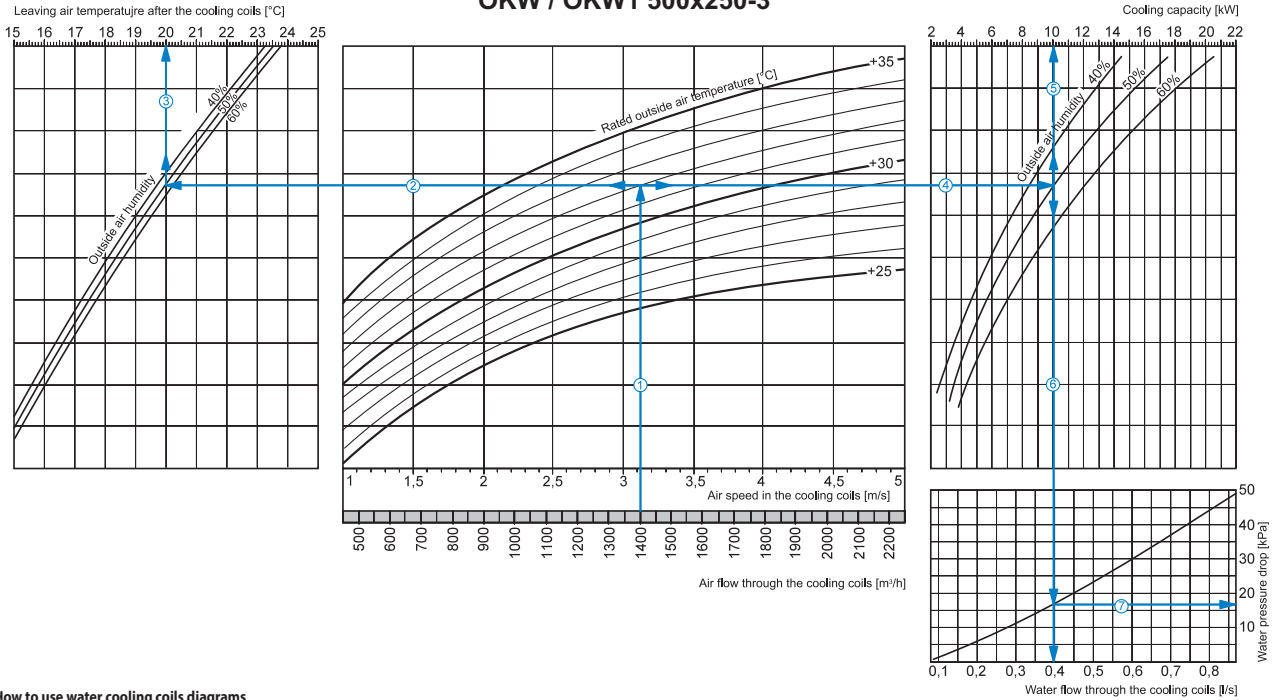

How to use water cooling coils diagrams

Air Speed. Starting from 1400 m³/h on the air flow scale draw a vertical line ① till the air speed axis. It makes 3.1 m/s.

- Supply air temperature. Prolong the line ① up to the point where it crosses the outside air temperature (e.g. +32 °C); then draw a horizontal line ② from this point to the left till crossing the outside air humidity (e.g. 50%). From this point draw a vertical line ③ to the supply air temperature at cooler outlet axis on top of the graphic (+20 °C).
- Cooling capacity. Prolong the line ① up to the point where it crosses the outside air temperature (e.g. +32 °C) and draw a horizontal line ④ from this point to the right until it crosses the outside air humidity curve (e.g., 50%), from here draw a vertical line ⑤ up to the scale representing the cooling capacity (10.0 kW).
- Water flow. Prolong the line ⑤ down to water flow axis at the bottom of the graphic ⑥ (0.4 l/s).
- Water pressure drop. Draw the line ⑦ from the point where the line ⑥ crosses the black curve to the pressure drop axis. (17.0 kPa).

OKW/OKW1

OKW / OKW1 500x300-3

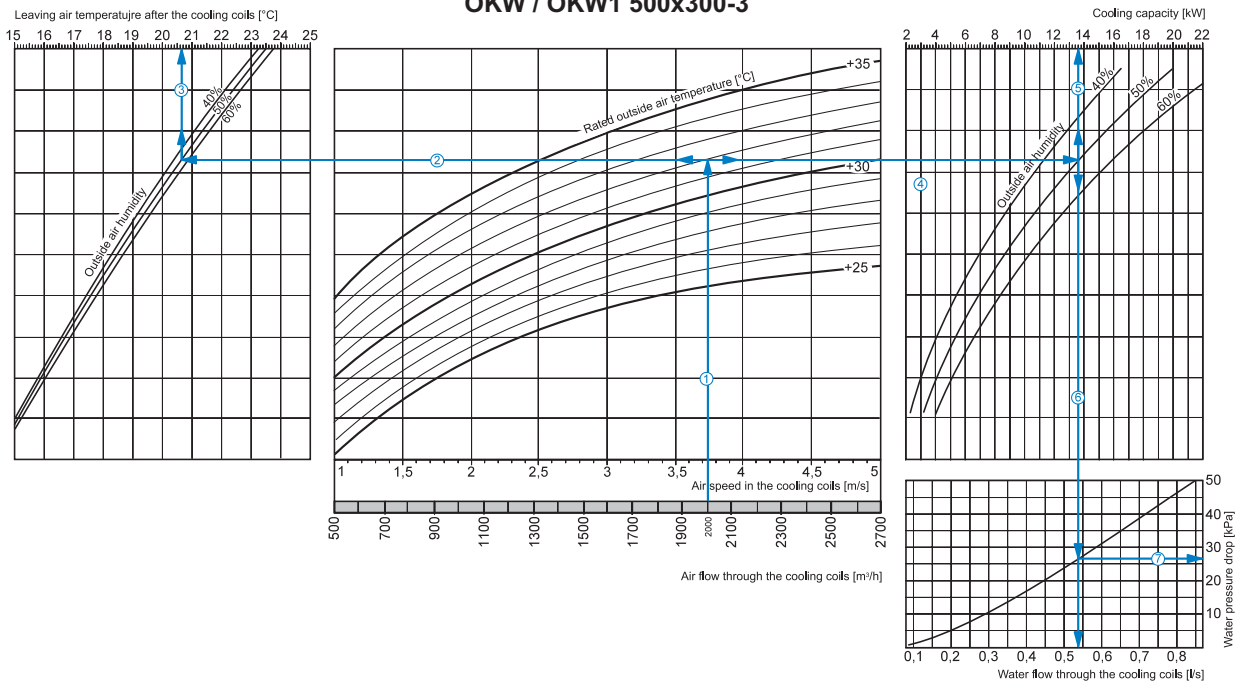

How to use water cooler diagrams

Air Speed. Starting from 2000 m³/h on the air flow scale draw a vertical line ① till the air speed axis. It makes 3.75 m/s.

- Supply air temperature. Prolong the line ① up to the point where it crosses the outside air temperature (e.g. +32 °C); then draw a horizontal line ② from this point to the left till crossing the outside air humidity (e.g. 50%). From this point draw a vertical line ③ to the supply air temperature at cooler outlet axis on top of the graphic (+20.6 °C).
- Cooling capacity. Prolong the line ① up to the point where it crosses the outside air temperature (e.g. +32 °C) and draw a horizontal line ④ from this point to the right until it crosses the outside air humidity curve (e.g., 50%), from here draw a vertical line ⑤ up to the scale representing the cooling capacity (13.6 kW).
- Water flow. Prolong the line ⑤ down to water flow axis at the bottom of the graphic ⑥ (0.54 l/s).
- Water pressure drop. Draw the line ⑦ from the point where the line ⑥ crosses the black curve to the pressure drop axis. (27.0 kPa).

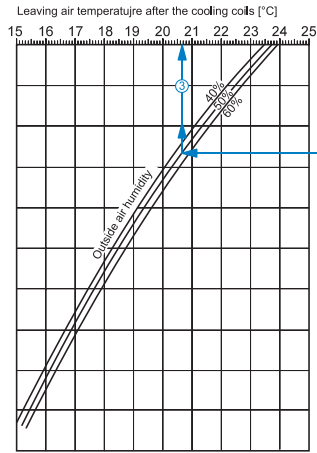

OKW / OKW1 600x300-3

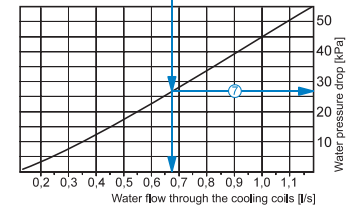
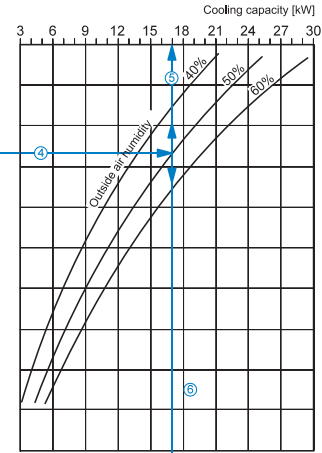
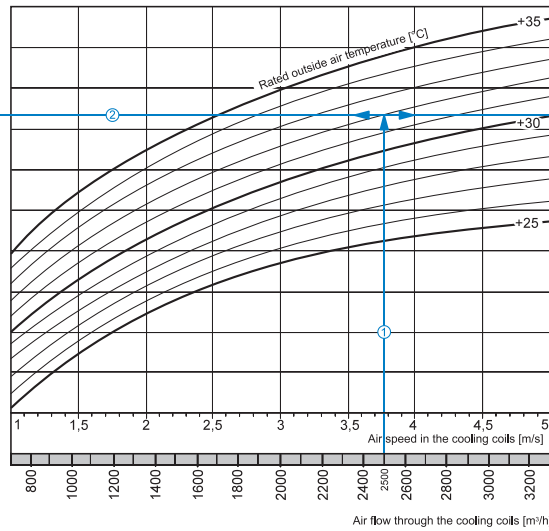

How to use water cooler diagrams

Air Speed. Starting from 2500 m³/h on the air flow scale draw a vertical line ① till the air speed axis. It makes 3.75 m/s.

Supply air temperature. Prolong the line ① up to the point where it crosses the outside air temperature (e.g. +32 °C); then draw a horizontal line ② from this point to the left till crossing the outside air humidity (e.g. 50 %). From this point draw a vertical line ③ to the supply air temperature at cooler outlet axis on top of the graphic (+20.7 °C).

Cooling capacity. Prolong the line ① up to the point where it crosses the outside air temperature (e.g. +32 °C) and draw a horizontal line ④ from this point to the right until it crosses the outside air humidity curve (e.g., 50 %), from here draw a vertical line ⑤ up to the scale representing the cooling capacity (17.0 kW).

Water flow. Prolong the line ⑤ down to water flow axis at the bottom of the graphic ⑥ (0.68 l/s).

Water pressure drop. Draw the line ⑦ from the point where the line ⑥ crosses the black curve to the pressure drop axis. (27.0 kPa).

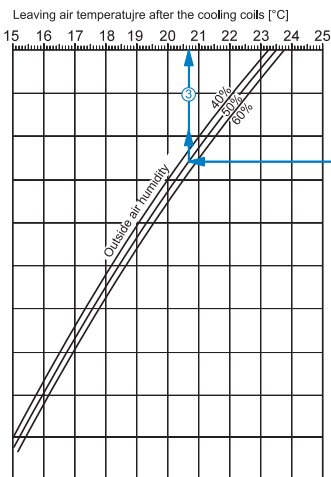

OKW / OKW1 600x350-3

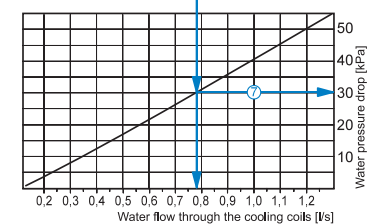
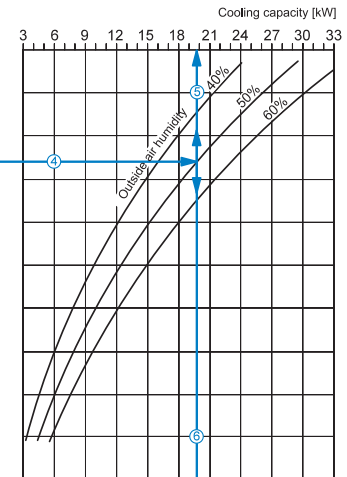
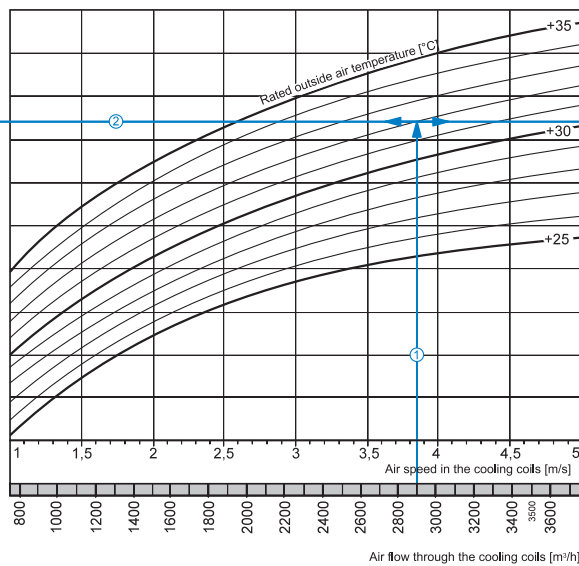

How to use water cooler diagrams

Air Speed. Starting from 2850 m³/h on the air flow scale draw a vertical line ① till the air speed axis. It makes 3.85 m/s.

Supply air temperature. Prolong the line ① up to the point where it crosses the outside air temperature (e.g. +32 °C); then draw a horizontal line ② from this point to the left till crossing the outside air humidity (e.g. 50 %). From this point draw a vertical line ③ to the supply air temperature at cooler outlet axis on top of the graphic (+20.7 °C).

Cooling capacity. Prolong the line ① up to the point where it crosses the outside air temperature (e.g. +32 °C) and draw a horizontal line ④ from this point to the right until it crosses the outside air humidity curve (e.g., 50 %), from here draw a vertical line ⑤ up to the scale representing the cooling capacity (19.8 kW).

Water flow. Prolong the line ⑤ down to water flow axis at the bottom of the graphic ⑥ (0.78 l/s).

Water pressure drop. Draw the line ⑦ from the point where the line ⑥ crosses the black curve to the pressure drop axis. (30.0 kPa).

OKW/OKW1

OKW / OKW1 700x400-3

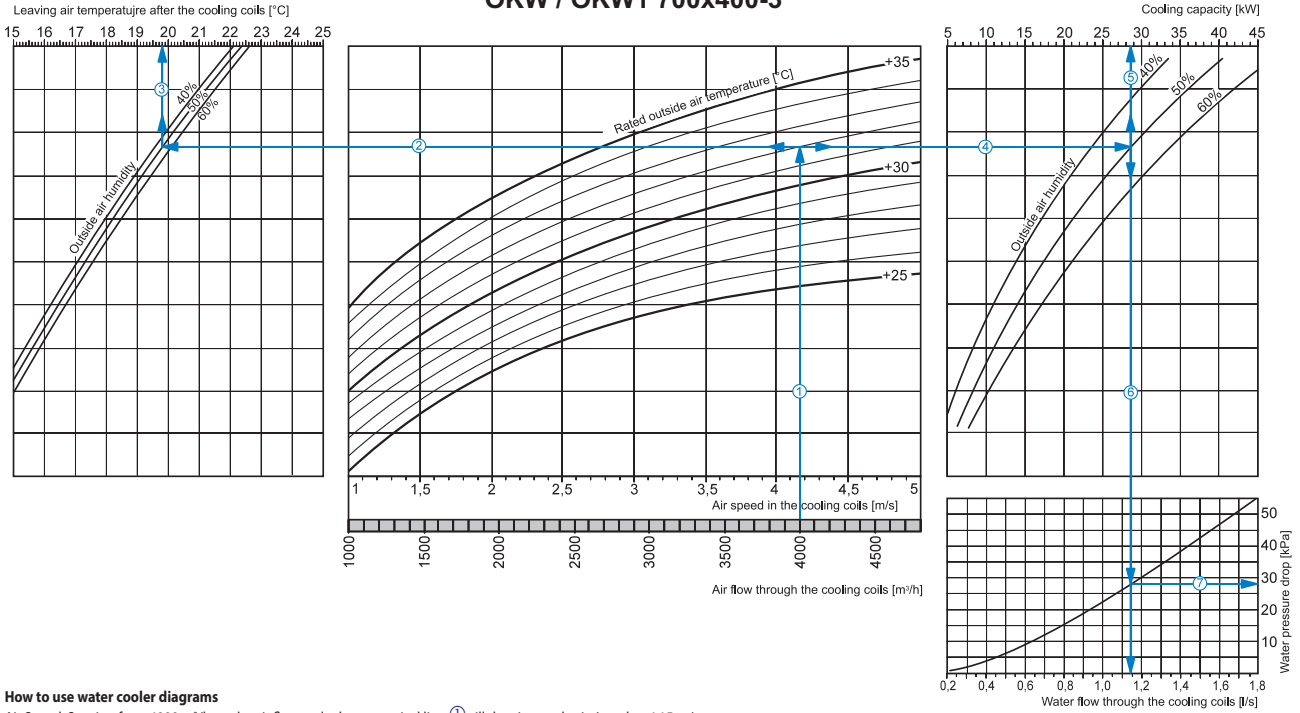

How to use water cooler diagrams

Air Speed. Starting from 4000 m³/h on the air flow scale draw a vertical line ① till the air speed axis. It makes 4.15 m/s.

Supply air temperature. Prolong the line ① up to the point where it crosses the outside air temperature (e.g. +32 °C); then draw a horizontal line ② from this point to the left till crossing the outside air humidity (e.g. 50 %). From this point draw a vertical line ③ to the supply air temperature at cooler outlet axis on top of the graphic (+19.8 °C).

Cooling capacity. Prolong the line ① up to the point where it crosses the outside air temperature (e.g. +32 °C) and draw a horizontal line ④ from this point to the right until it crosses the outside air humidity curve (e.g., 50 %), from here draw a vertical line ⑤ up to the scale representing the cooling capacity (28.5 kW).

Water flow. Prolong the line ⑤ down to water flow axis at the bottom of the graphic ⑥ (1.14 l/s).

Water pressure drop. Draw the line ⑦ from the point where the line ⑥ crosses the black curve to the pressure drop axis. (28.0 kPa).

OKW/OKW1

OKW / OKW1 800x500-3

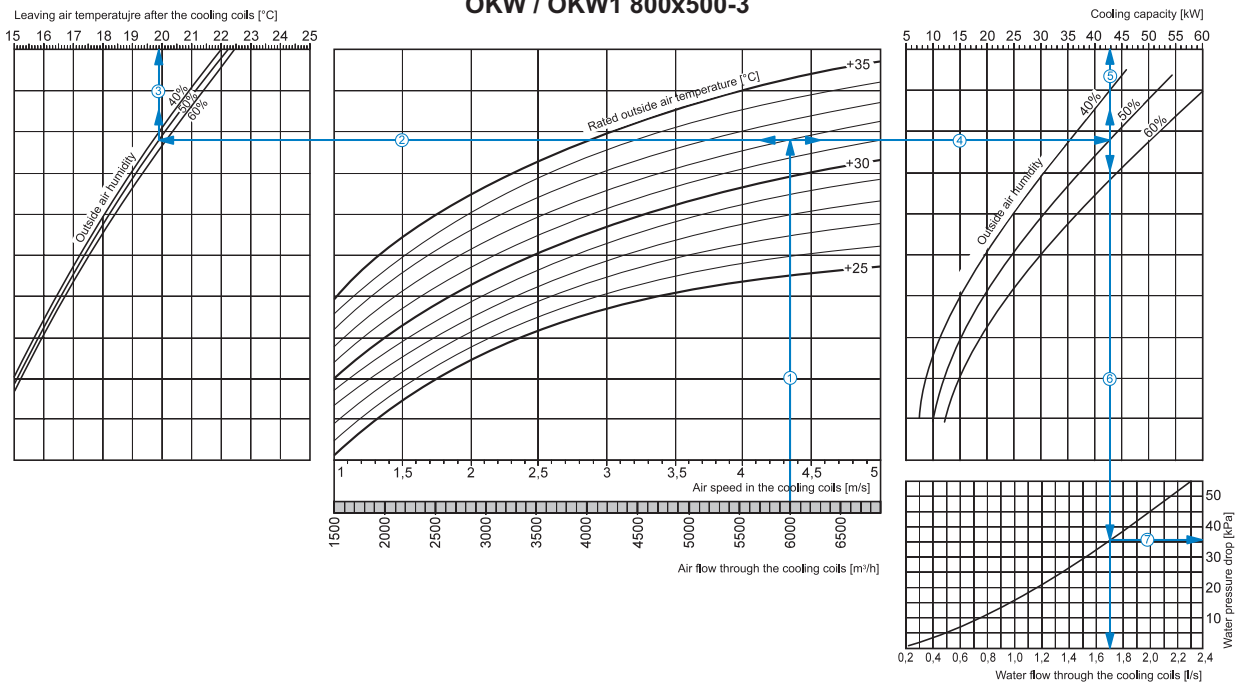

How to use water cooler diagrams

Air Speed. Starting from 6000 m³/h on the air flow scale draw a vertical line ① till the air speed axis. It makes 4.35 m/s.

Supply air temperature. Prolong the line ① up to the point where it crosses the outside air temperature (e.g. +32 °C); then draw a horizontal line ② from this point to the left till crossing the outside air humidity (e.g. 50 %). From this point draw a vertical line ③ to the supply air temperature at cooler outlet axis on top of the graphic (+19.9 °C).

Cooling capacity. Prolong the line ① up to the point where it crosses the outside air temperature (e.g. +32 °C) and draw a horizontal line ④ from this point to the right until it crosses the outside air humidity curve (e.g., 50 %), from here draw a vertical line ⑤ up to the scale representing the cooling capacity (43 kW).

Water flow. Prolong the line ⑤ down to water flow axis at the bottom of the graphic ⑥ (1.7 l/s).

Water pressure drop. Draw the line ⑦ from the point where the line ⑥ crosses the black curve to the pressure drop axis. (36.0 kPa).

OKW / OKW1 900x500-3

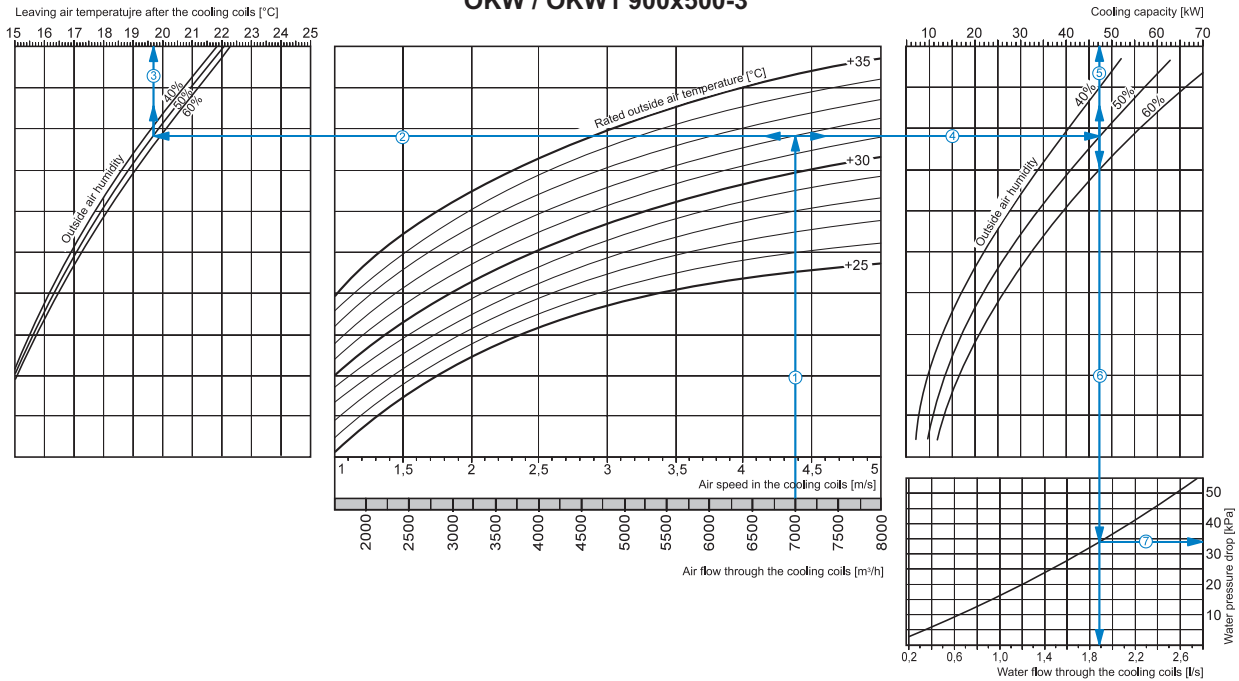

How to use water cooler diagrams

Air Speed. Starting from 7000 m³/h on the air flow scale draw a vertical line ① till the air speed axis. It makes 4.4 m/s.

Supply air temperature. Prolong the line ① up to the point where it crosses the outside air temperature (e.g. +32 °C); then draw a horizontal line ② from this point to the left till crossing the outside air humidity (e.g. 50 %). From this point draw a vertical line ③ to the supply air temperature at cooler outlet axis on top of the graphic (+19.7 °C).

Cooling capacity. Prolong the line ① up to the point where it crosses the outside air temperature (e.g. +32 °C) and draw a horizontal line ④ from this point to the right until it crosses the outside air humidity curve (e.g., 50 %), from here draw a vertical line ⑤ up to the scale representing the cooling capacity (47.0 kW).

Water flow. Prolong the line ⑤ down to water flow axis at the bottom of the graphic ⑥ (1.9 l/s).

Water pressure drop. Draw the line ⑦ from the point where the line ⑥ crosses the black curve to the pressure drop axis. (34.0 kPa).

OKW/OKW1

OKW / OKW1 1000x500-3

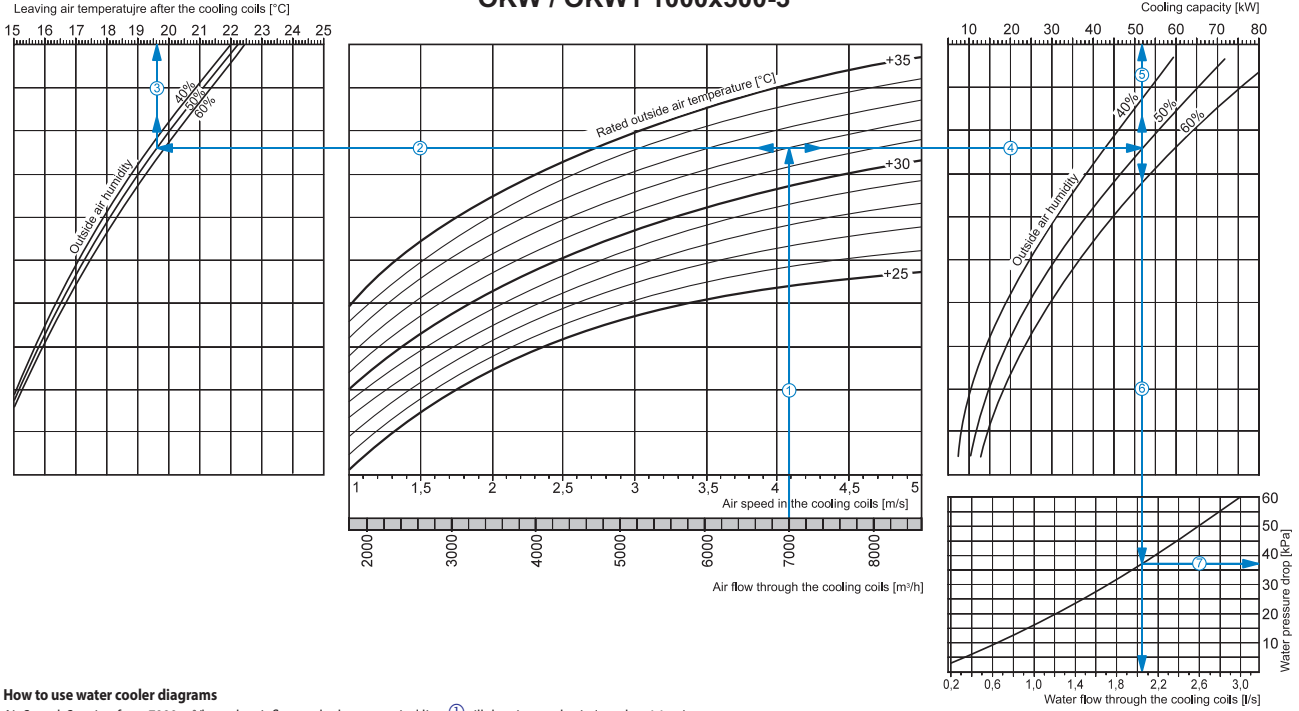

How to use water cooler diagrams

Air Speed. Starting from 7000 m³/h on the air flow scale draw a vertical line ① till the air speed axis. It makes 4.1 m/s.

- **Supply air temperature.** Prolong the line ① up to the point where it crosses the outside air temperature (e.g. +32 °C); then draw a horizontal line ② from this point to the left till crossing the outside air humidity (e.g. 50 %). From this point draw a vertical line ③ to the supply air temperature at cooler outlet axis on top of the graphic (+19.6 °C).
- **Cooling capacity.** Prolong the line ① up to the point where it crosses the outside air temperature (e.g. +32 °C) and draw a horizontal line ④ from this point to the right until it crosses the outside air humidity curve (e.g., 50 %), from here draw a vertical line ⑤ up to the scale representing the cooling capacity (52.0 kW).
- **Water flow.** Prolong the line ⑤ down to water flow axis at the bottom of the graphic ⑥ (2.05 l/s).
- **Water pressure drop.** Draw the line ⑦ from the point where the line ⑥ crosses the black curve to the pressure drop axis. (37.0 kPa).

Series
OKF



Series
OKF1



■ **Applications**

Direct-expansion duct coolers are designed for cooling of supply air in rectangular ventilation systems and can be used either for supply or supply and exhaust units.

■ **Design**

The DX coolers are available in OKF and OKF1 modifications. The OKF1 cooler has a simplified design. The cooler casing is made of galvanized steel, the piping is made of copper tubes and the heat exchange surface is made of aluminium plates. The coolers are available in 3 rows modification and designed for operation with R123, R134a, R152a, R404a, R407c, R410a, R507, R12, R22 cooling agents. It is equipped with a droplet separator and a drain pan for condensate collection and removal. For OKF and OKF1 models by default the service side is located on the right side from the air stream direction. The OKF cooler service side location can be changed by coil turning by 180°. The OKF1 modification does not have this option.

■ **Mounting**

- ▶ Mounting is effected by means of flange connection. Direct-expansion cooling coils, can be installed horizontally only to enable the condensate draining.
- ▶ Installation shall be performed in such a way as to provide the uniform air stream distribution along the entire cross section.

- ▶ The air filter shall be installed at the cooler inlet to ensure the cooler protection against dirt and dusting.
- ▶ The cooler can be installed at the fan inlet or outlet. If the cooler is located at the fan outlet the air duct between the cooler and the fan shall be at least 1-1.5 m long to ensure the air stream stabilization.
- ▶ To attain the maximum cooling capacity the cooler must be connected on counter-flow basis. All the nomographic charts in the catalogue are valid for such connection.
- ▶ The droplet separator is made of polypropylene profile and prevents condensate dripping from the cooling tubes by the cooling air flow. While selecting a cooler type consider that the most suitable speed of

the air flow for the efficient droplet separator operation is up to 4 m/s.

- ▶ Condensate draining from the cooler shall be performed through the U-trap. The U-trap height depends on the total pressure in the fan. The trap height can be calculated using the figure and the table below.

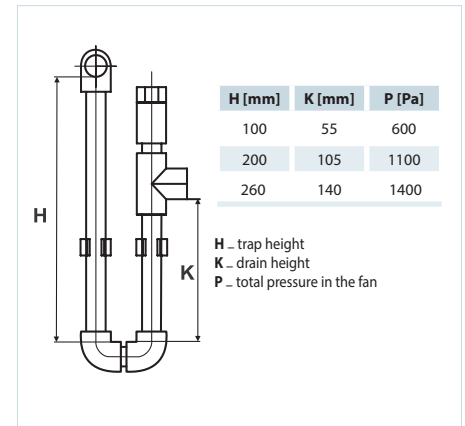

- ▶ To ensure the correct and safe cooler operation use the automation system providing the complex control and automatic regulation of the cooling capacity and air cooling temperature.

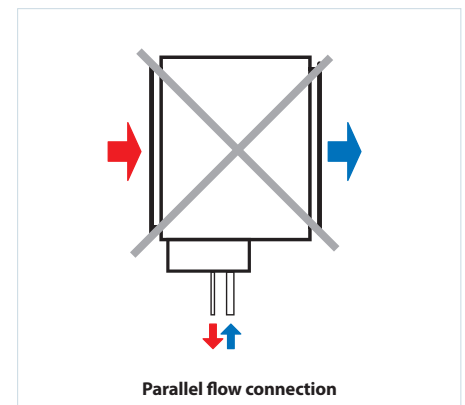
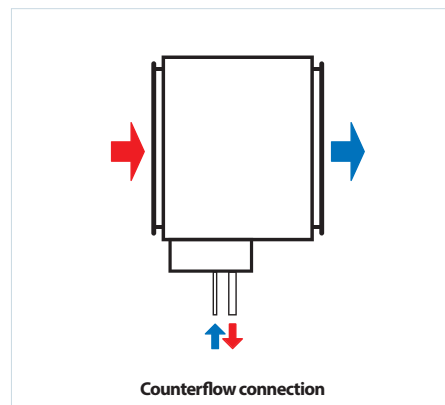

Series	Flange dimensions (WxH) [mm]	Number of cooling coils
OKF/OKF1	400x200; 500x250; 500x300; 600x300; 600x350; 700x400; 800x500; 900x500; 1000x500	3

Designation key

Series	Flange dimensions (WxH) [mm]	Number of cooling coils	Modification (for OKF1)
OKF/OKF1	400x200; 500x250; 500x300; 600x300; 600x350; 700x400; 800x500; 900x500; 1000x500	3	_: right-handed L: left-handed

Overall dimensions

Type	Dimensions [mm]											
	B	B1	B2	B3	H	H1	H2	H3	H4	L	D1	D2
OKF 400x200-3	400	420	440	470	200	220	240	295	103	44	12	22
OKF 500x250-3	500	520	540	570	250	270	290	345	155	44	12	22
OKF 500x300-3	500	520	540	570	300	320	340	395	210	33	12	22
OKF 600x300-3	600	620	640	670	300	320	340	395	199	44	18	28
OKF 600x350-3	600	620	640	670	350	370	390	445	199	44	18	28
OKF 700x400-3	700	720	740	770	400	420	440	495	224	44	22	28
OKF 800x500-3	800	820	840	870	500	520	540	595	340	44	22	28
OKF 900x500-3	900	920	940	970	500	520	540	595	340	44	22	28
OKF 1000x500-3	1000	1020	1040	1070	500	520	540	595	325	44	22	28

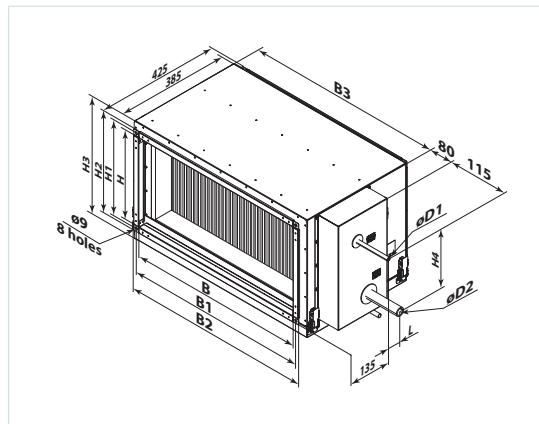

Overall dimensions

Type	Dimensions [mm]										
	B	B1	B2	H	H1	H2	H3	L	D1	D2	
OKF1 400x200-3	400	420	580	200	220	270	103	44	12	22	
OKF1 500x250-3	500	520	680	250	270	320	155	44	12	22	
OKF1 500x300-3	500	520	680	300	320	370	210	33	12	22	
OKF1 600x300-3	600	620	780	300	320	370	199	44	18	28	
OKF1 600x350-3	600	620	780	350	370	420	199	44	18	28	
OKF1 700x400-3	700	720	880	400	420	470	224	44	22	28	
OKF1 800x500-3	800	820	980	500	520	570	340	44	22	28	
OKF1 900x500-3	900	920	1080	500	520	570	340	44	22	28	
OKF1 1000x500-3	1000	1020	1180	500	520	570	325	44	22	28	

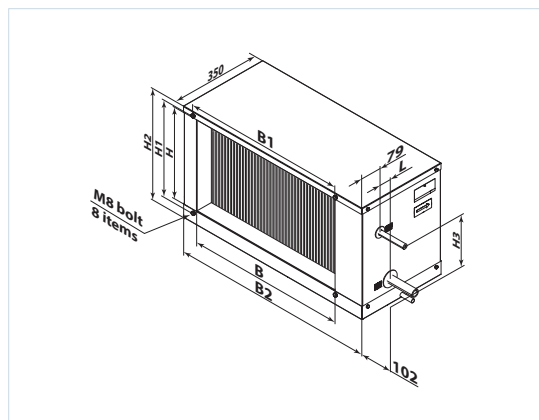

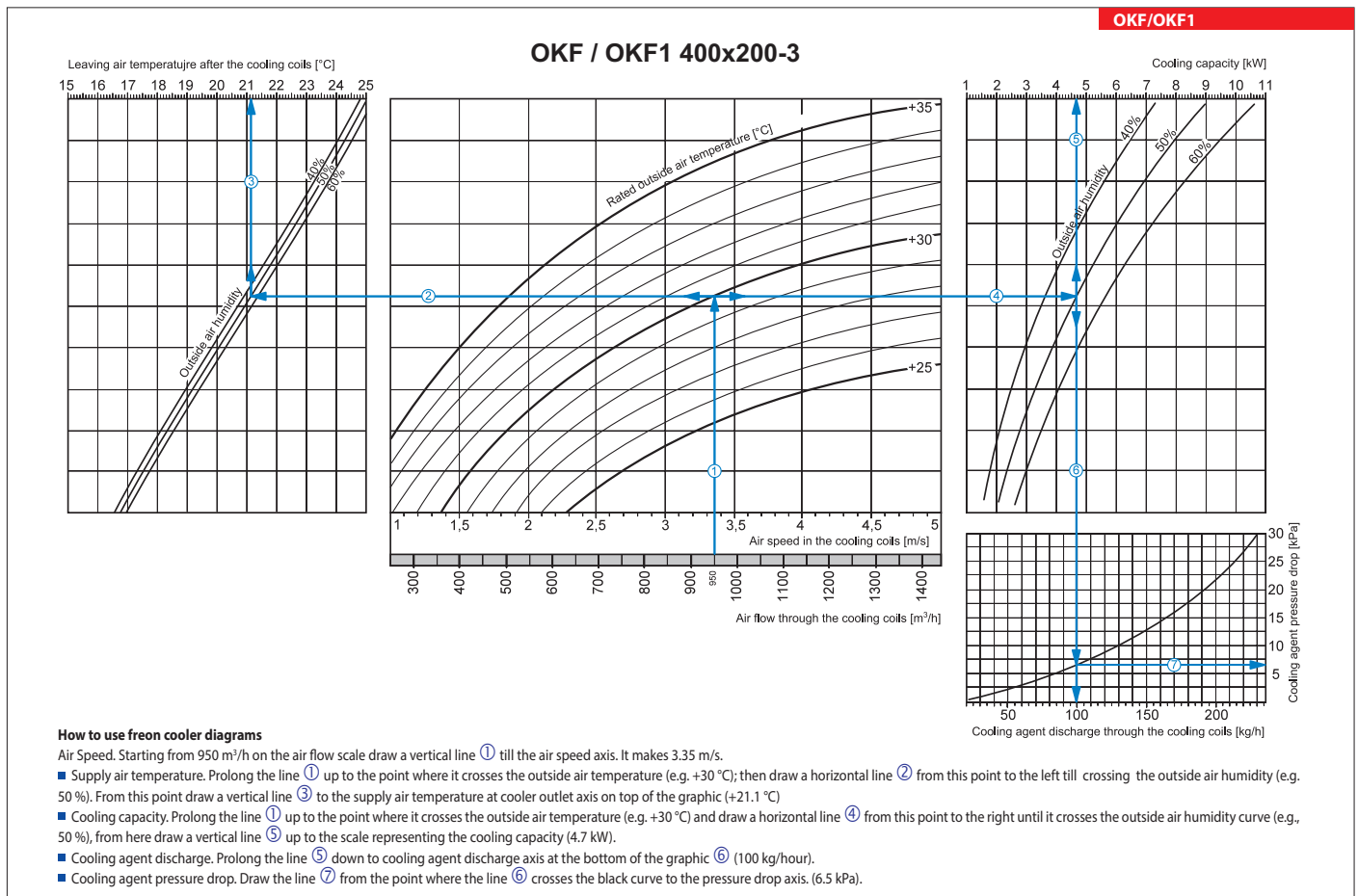
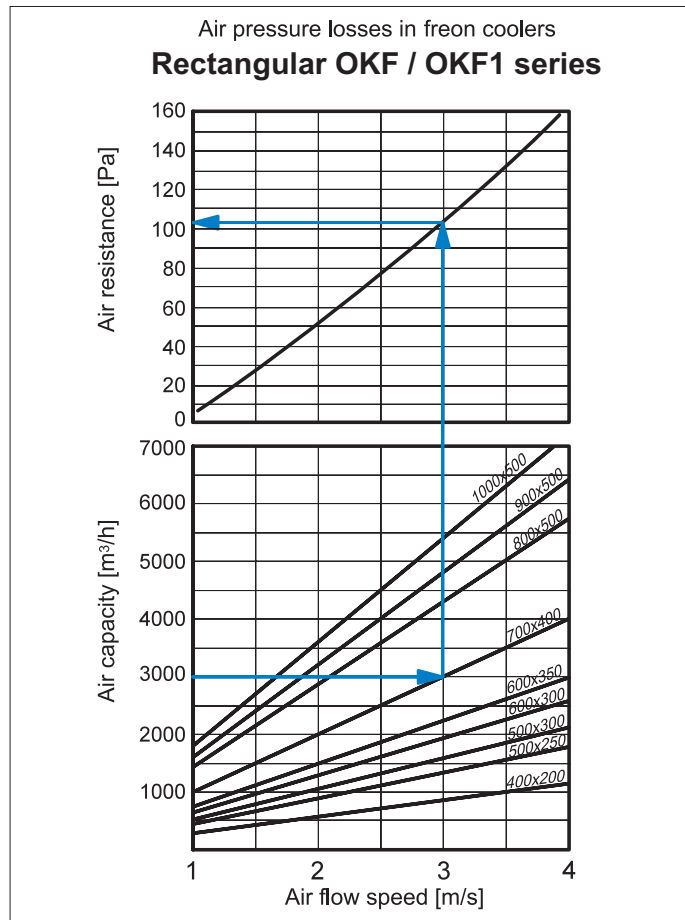

OKF/OKF1

OKF / OKF1 500x250-3

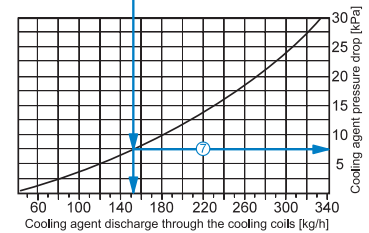
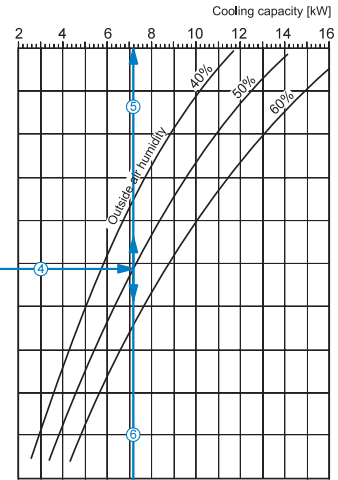
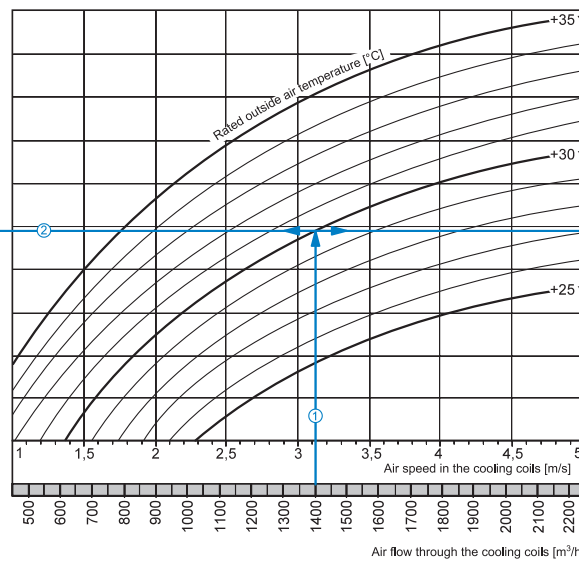
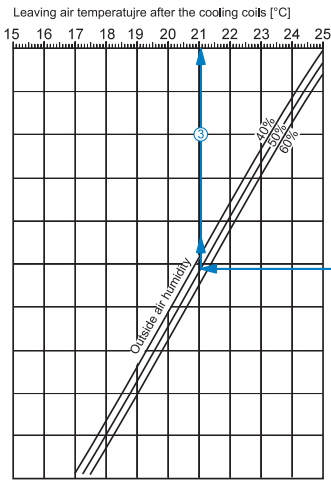

How to use freon cooler diagrams

Air Speed. Starting from 1400 m³/h on the air flow scale draw a vertical line ① till the air speed axis. It makes 3.1 m/s.

Supply air temperature. Prolong the line ① up to the point where it crosses the outside air temperature (e.g. +30 °C); then draw a horizontal line ② from this point to the left till crossing the outside air humidity (e.g. 50 %). From this point draw a vertical line ③ to the supply air temperature at cooler outlet axis on top of the graphic (+21.1 °C).

Cooling capacity. Prolong the line ① up to the point where it crosses the outside air temperature (e.g. +30 °C) and draw a horizontal line ④ from this point to the right until it crosses the outside air humidity curve (e.g., 50 %), from here draw a vertical line ⑤ up to the scale representing the cooling capacity (7.2 kW).

Cooling agent discharge. Prolong the line ⑤ down to cooling agent discharge axis at the bottom of the graphic ⑥ (152 kg/hour).

Cooling agent pressure drop. Draw the line ⑦ from the point where the line ⑥ crosses the black curve to the pressure drop axis. (7.5 kPa).

OKF/OKF1

OKF / OKF1 500x300-3

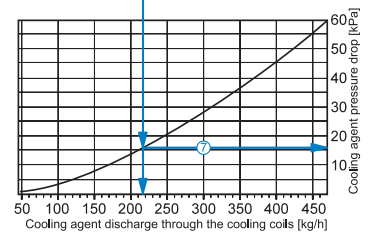
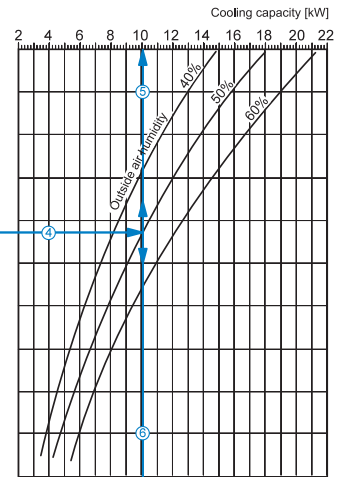
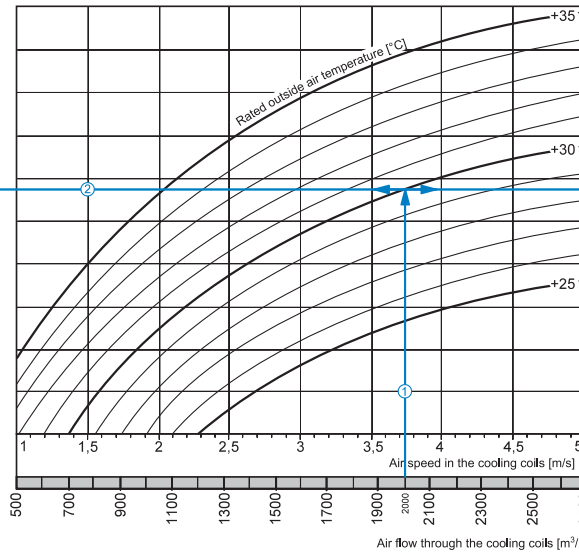
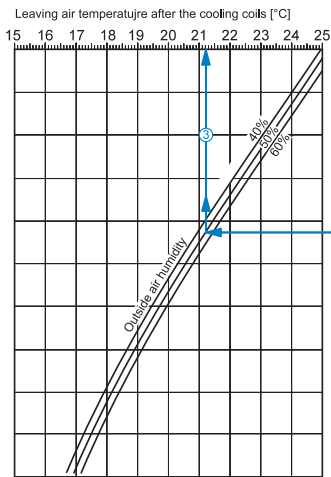

How to use freon cooler diagrams

Air Speed. Starting from 2000 m³/h on the air flow scale draw a vertical line ① till the air speed axis. It makes 3.75 m/s.

Supply air temperature. Prolong the line ① up to the point where it crosses the outside air temperature (e.g. +30 °C); then draw a horizontal line ② from this point to the left till crossing the outside air humidity (e.g. 50 %). From this point draw a vertical line ③ to the supply air temperature at cooler outlet axis on top of the graphic (+21.2 °C).

Cooling capacity. Prolong the line ① up to the point where it crosses the outside air temperature (e.g. +30 °C) and draw a horizontal line ④ from this point to the right until it crosses the outside air humidity curve (e.g., 50 %), from here draw a vertical line ⑤ up to the scale representing the cooling capacity (10 kW).

Cooling agent discharge. Prolong the line ⑤ down to cooling agent discharge axis at the bottom of the graphic ⑥ (215 kg/hour).

Cooling agent pressure drop. Draw the line ⑦ from the point where the line ⑥ crosses the black curve to the pressure drop axis. (16.0 kPa).

OKF/OKF1

OKF / OKF1 600x300-3

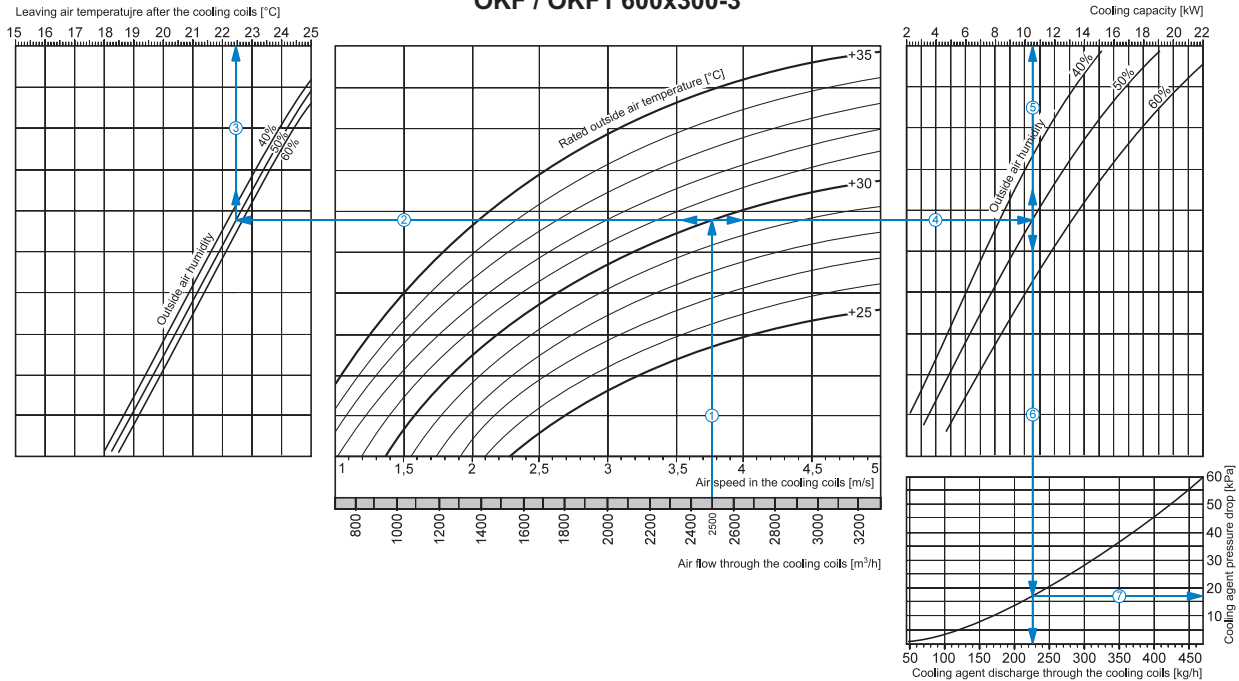

How to use freon cooler diagrams

Air Speed. Starting from 2500 m³/h on the air flow scale draw a vertical line ① till the air speed axis. It makes 3.75 m/s.

- Supply air temperature. Prolong the line ① up to the point where it crosses the outside air temperature (e.g. +30 °C); then draw a horizontal line ② from this point to the left till crossing the outside air humidity (e.g. 50 %). From this point draw a vertical line ③ to the supply air temperature at cooler outlet axis on top of the graphic (+22.5 °C).
- Cooling coil capacity. Prolong the line ① up to the point where it crosses the outside air temperature (e.g. +30 °C) and draw a horizontal line ④ from this point to the right until it crosses the outside air humidity curve (e.g. 50 %), from here draw a vertical line ⑤ up to the scale representing the cooling capacity (10.5 kW).
- Cooling agent discharge. Prolong the line ⑤ down to cooling agent discharge axis at the bottom of the graphic ⑥ (225 kg/hour).
- Cooling agent pressure drop. Draw the line ⑦ from the point where the line ⑥ crosses the black curve to the pressure drop axis. (17.0 kPa).

OKF/OKF1

OKF / OKF1 600x350-3

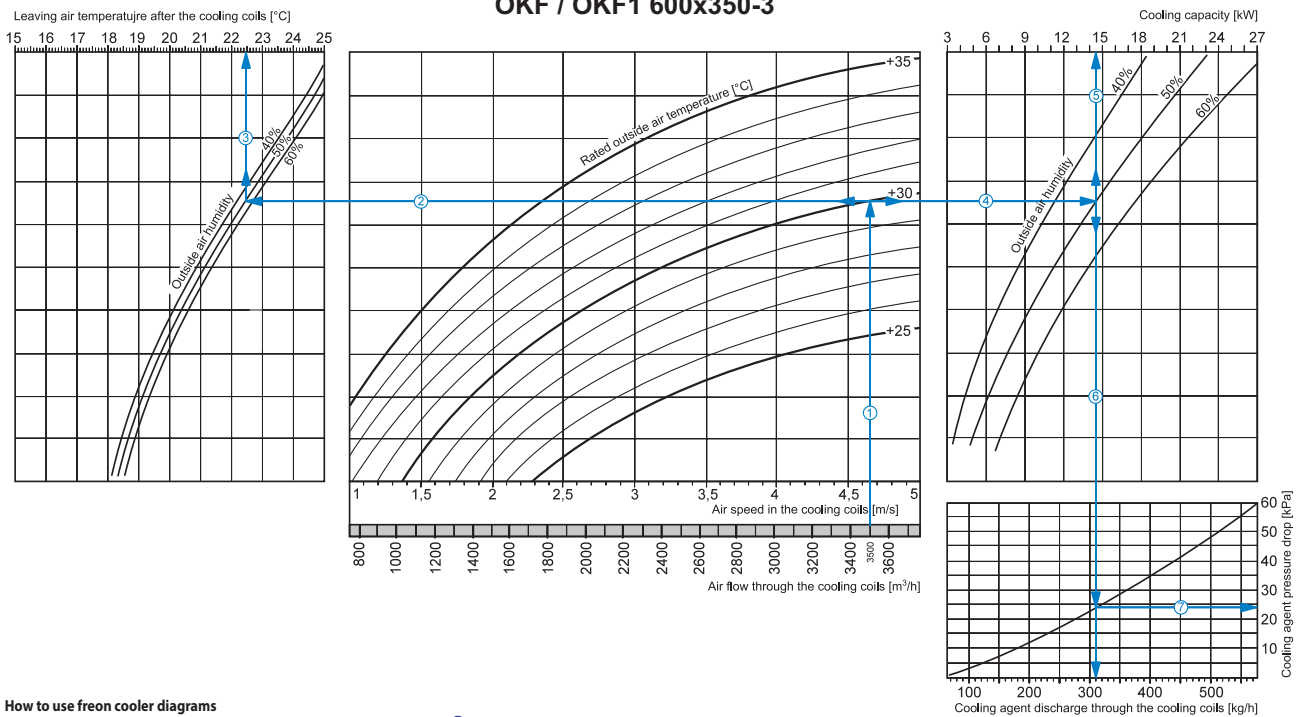

How to use freon cooler diagrams

Air Speed. Starting from 3500 m³/h on the air flow scale draw a vertical line ① till the air speed axis. It makes 4.65 m/s.

- Supply air temperature. Prolong the line ① up to the point where it crosses the outside air temperature (e.g. +30 °C); then draw a horizontal line ② from this point to the left till crossing the outside air humidity (e.g. 50 %). From this point draw a vertical line ③ to the supply air temperature at cooler outlet axis on top of the graphic (+22.5 °C).
- Cooling coil capacity. Prolong the line ① up to the point where it crosses the outside air temperature (e.g. +30 °C) and draw a horizontal line ④ from this point to the right until it crosses the outside air humidity curve (e.g. 50 %), from here draw a vertical line ⑤ up to the scale representing the cooling capacity (14.5 kW).
- Cooling agent discharge. Prolong the line ⑤ down to cooling agent discharge axis at the bottom of the graphic ⑥ (310 kg/hour).
- Cooling agent pressure drop. Draw the line ⑦ from the point where the line ⑥ crosses the black curve to the pressure drop axis. (24.0 kPa).

OKF/OKF1

OKF / OKF1 700x400-3

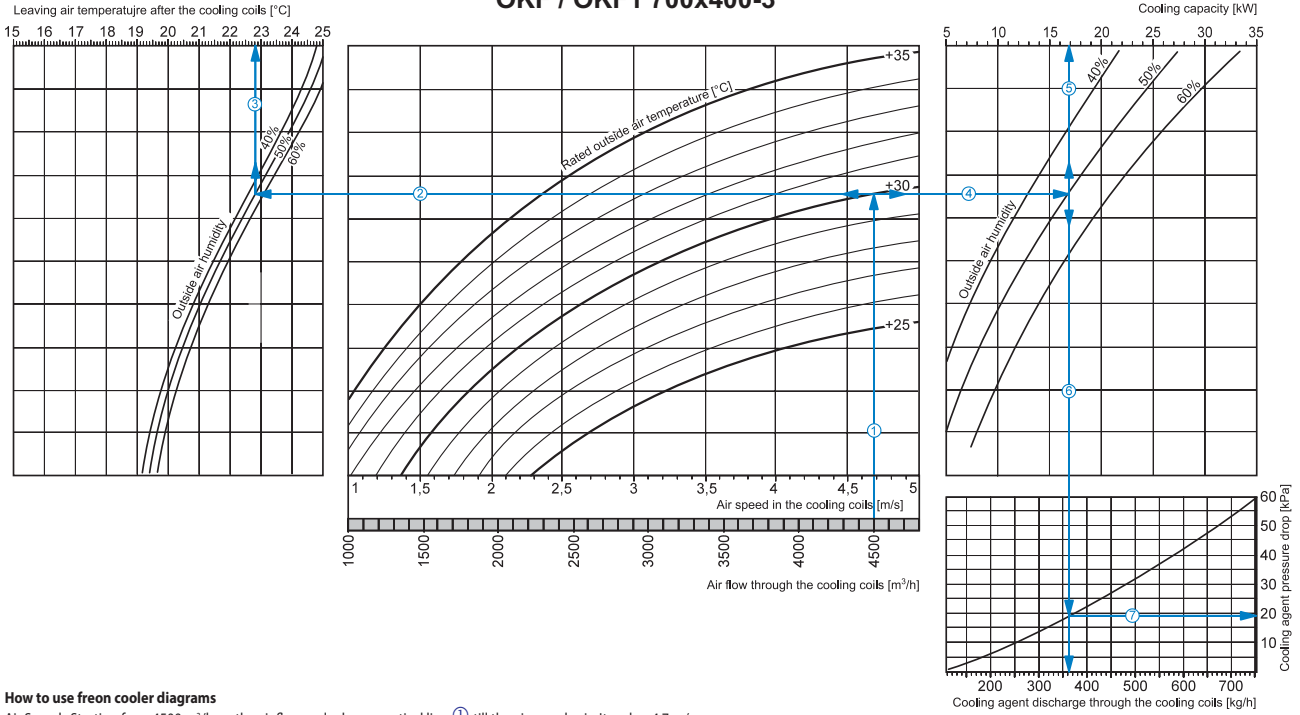

How to use freon cooler diagrams

- Air Speed. Starting from 4500 m³/h on the air flow scale draw a vertical line ① till the air speed axis. It makes 4.7 m/s.
- Supply air temperature. Prolong the line ① up to the point where it crosses the outside air temperature (e.g. +30 °C); then draw a horizontal line ② from this point to the left till crossing the outside air humidity (e.g. 50 %). From this point draw a vertical line ③ to the supply air temperature at cooler outlet axis on top of the graphic (+22.8 °C).
- Cooling coil capacity. Prolong the line ① up to the point where it crosses the outside air temperature (e.g. +30 °C) and draw a horizontal line ④ from this point to the right until it crosses the outside air humidity curve (e.g., 50 %), from here draw a vertical line ⑤ up to the scale representing the cooling capacity (17.0 kW).
- Cooling agent discharge. Prolong the line ⑤ down to cooling agent discharge axis at the bottom of the graphic ⑥ (360 kg/hour).
- Cooling agent pressure drop. Draw the line ⑦ from the point where the line ⑥ crosses the black curve to the pressure drop axis. (19.0 kPa).

OKF/OKF1

OKF / OKF1 800x500-3

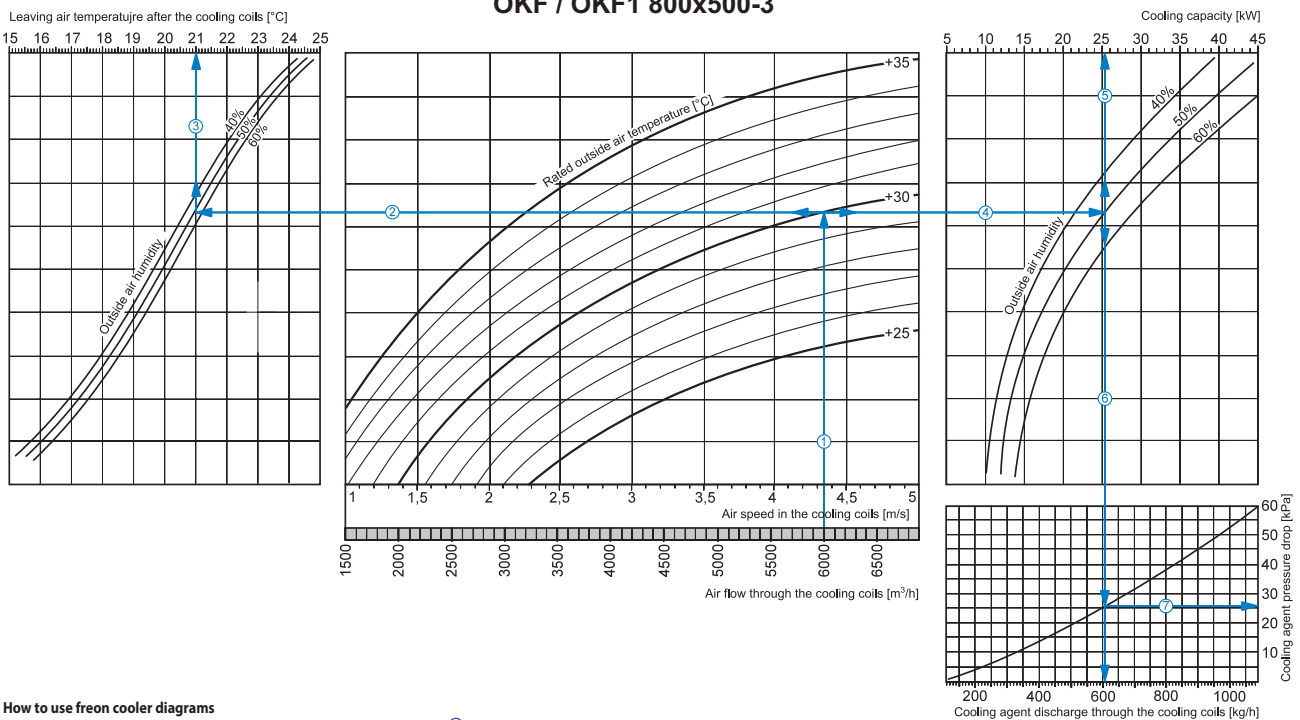

How to use freon cooler diagrams

- Air Speed. Starting from 6000 m³/h on the air flow scale draw a vertical line ① till the air speed axis. It makes 4.35 m/s.
- Supply air temperature. Prolong the line ① up to the point where it crosses the outside air temperature (e.g. +30 °C); then draw a horizontal line ② from this point to the left till crossing the outside air humidity (e.g. 50 %). From this point draw a vertical line ③ to the supply air temperature at cooler outlet axis on top of the graphic (+21.0 °C).
- Cooling coil capacity. Prolong the line ① up to the point where it crosses the outside air temperature (e.g. +30 °C) and draw a horizontal line ④ from this point to the right until it crosses the outside air humidity curve (e.g., 50 %), from here draw a vertical line ⑤ up to the scale representing the cooling capacity (25.5 kW).
- Cooling agent discharge. Prolong the line ⑤ down to cooling agent discharge axis at the bottom of the graphic ⑥ (605 kg/hour).
- Cooling agent pressure drop. Draw the line ⑦ from the point where the line ⑥ crosses the black curve to the pressure drop axis. (26.0 kPa).

OKF / OKF1 900x500-3

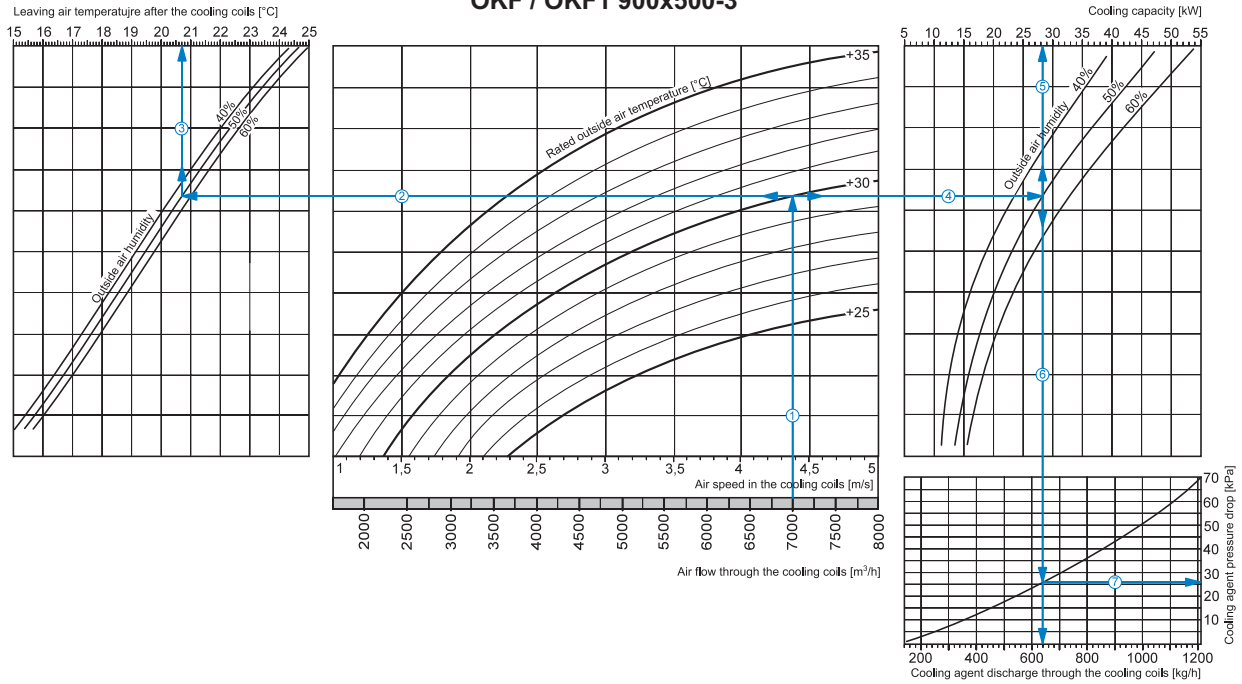

How to use freon cooler diagrams

Air Speed. Starting from 7000 m³/h on the air flow scale draw a vertical line ① till the air speed axis. It makes 4.4 m/s.

- Supply air temperature. Prolong the line ① up to the point where it crosses the outside air temperature (e.g. +30 °C); then draw a horizontal line ② from this point to the left till crossing the outside air humidity (e.g. 50 %). From this point draw a vertical line ③ to the supply air temperature at cooler outlet axis on top of the graphic (+20.7 °C).
- Cooling coil capacity. Prolong the line ① up to the point where it crosses the outside air temperature (e.g. +30 °C) and draw a horizontal line ④ from this point to the right until it crosses the outside air humidity curve (e.g. 50 %), from here draw a vertical line ⑤ up to the scale representing the cooling capacity (28.0 kW).
- Cooling agent discharge. Prolong the line ⑤ down to cooling agent discharge axis at the bottom of the graphic ⑥ (640 kg/hour).
- Cooling agent pressure drop. Draw the line ⑦ from the point where the line ⑥ crosses the black curve to the pressure drop axis. (26.0 kPa).

OKF/OKF1

OKF / OKF1 1000x500-3

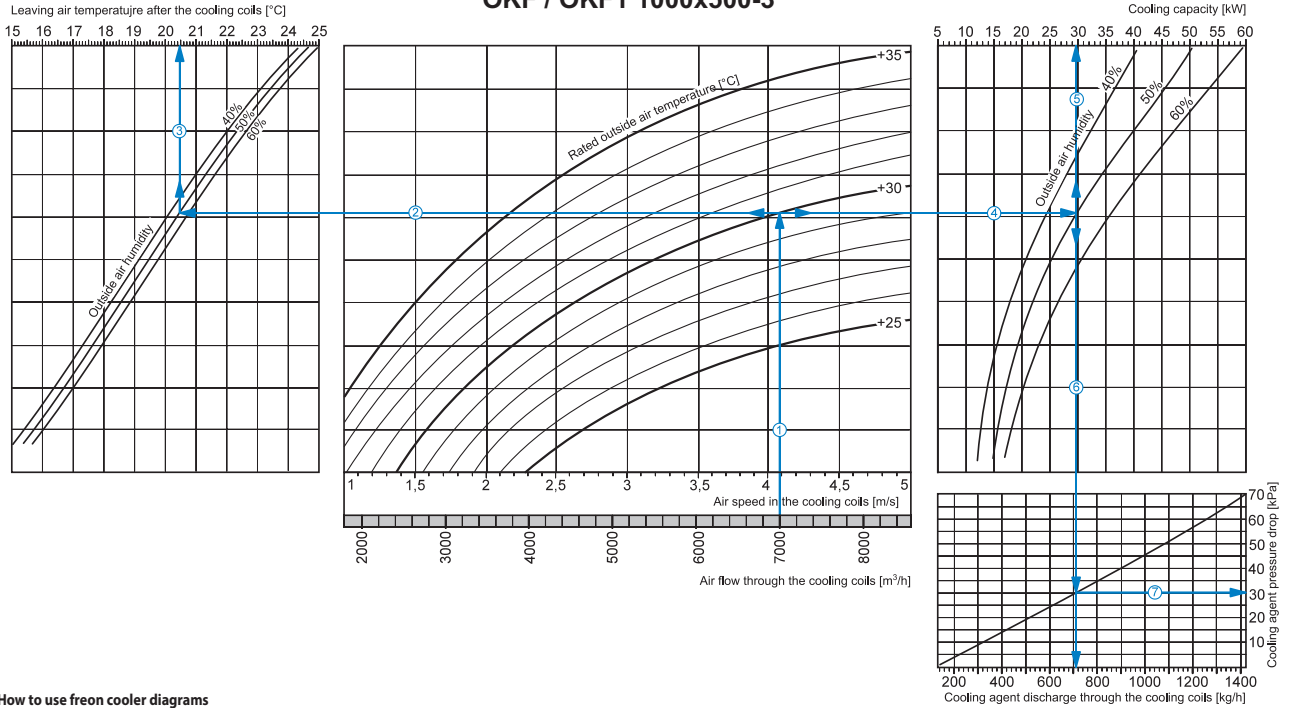

How to use freon cooler diagrams

Air Speed. Starting from 7000 m³/h on the air flow scale draw a vertical line ① till the air speed axis. It makes 4.1 m/s.

- Supply air temperature. Prolong the line ① up to the point where it crosses the outside air temperature (e.g. +30 °C); then draw a horizontal line ② from this point to the left till crossing the outside air humidity (e.g. 50 %). From this point draw a vertical line ③ to the supply air temperature at cooler outlet axis on top of the graphic (+20.5 °C).
- Cooling coil capacity. Prolong the line ① up to the point where it crosses the outside air temperature (e.g. +30 °C) and draw a horizontal line ④ from this point to the right until it crosses the outside air humidity curve (e.g., 50 %), from here draw a vertical line ⑤ up to the scale representing the cooling capacity (30.0 kW).
- Cooling agent discharge. Prolong the line ⑤ down to cooling agent discharge axis at the bottom of the graphic ⑥ (710 kg/hour).
- Cooling agent pressure drop. Draw the line ⑦ from the point where the line ⑥ crosses the black curve to the pressure drop axis. (30.0 kPa).

Series
USWK

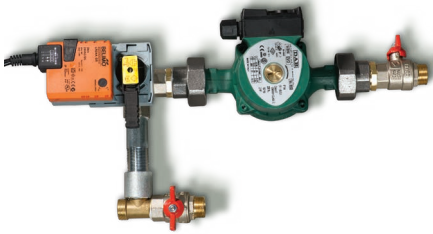

■ **Application**

The mixing unit USWK is designed for smooth heat medium flow control in ventilation systems equipped with water heaters or coolers for supply air temperature regulation. The mixing unit controls heat medium flow supplied to the water heat exchanger and in such a way maintains the supply air temperature. The mixing unit USWK is compatible with NKV water heaters, duct coolers OKW as well as all water heat exchangers (both heaters and coolers) integrated into air handling units.

■ **Design and operating logic**

Design of the mixing unit USWK is shown in fig. 1. The circulation pump (1) of the mixing unit ensures ongoing heat medium circulation through the water heat exchanger. The heat medium regulating three-way valve (3) with electric actuator (2) is installed before the circulation pump to mix the water supplied from the heating (cooling) system with the return water supplied through the recirculation pipe (4). The three-way valve is designed to provide the mixing ratio of two water streams and thus to control the heat medium temperature supplied to the water heat exchanger. The three-way valve actuator is controlled by 0-10 V output signal from the ventilation control system.

■ **Connection to water mains**

The mixing unit is connected directly to the water heat exchanger and water mains through rigid and/or flexible pipes.

In case of flexible pipe connection, fix the mixing unit firmly to the wall or another rigid surface with clamps. While installing the mixing unit keep the motor horizontal position to disable any distortions and mechanical loads from the connected pipelines to USWK unit. While connecting the mixing unit to water mains make sure of no loads and distortions that may damage the unit structure and provoke USWK airtightness breach. While connecting the pipelines ensure their quick detachment for scheduled servicing and maintenance operations.

■ **Electric connection**

All electric installations are allowed by qualified electricians with valid permit for electric operations. Before connecting the pump make sure to have grounded it. Make steps to prevent contact with power cables.

■ **Operating conditions**

The pump motor bearings are greased by the pumped medium. The single phase pumps do not require extra overload protection and the three phase pumps must be provided with external overload protection. The maximum allowable heat medium pressure in the unit is 10 bar.

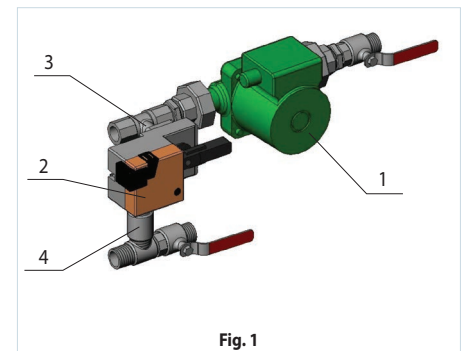
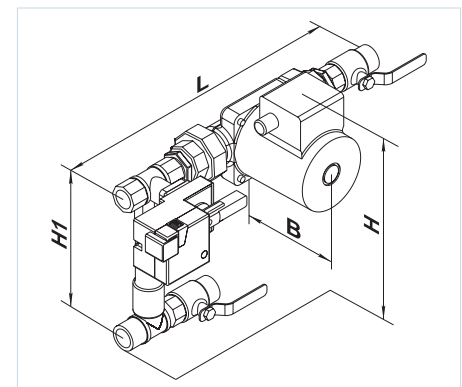

Fig. 1

Overall dimensions

Type	Dimensions [mm]				Mass [kg]
	B	H	H1	L	
USWK 3/4-4	150	290	180	460	4.1
USWK 3/4-6	150	290	180	460	4.1
USWK 1-6	175	320	210	490	6.8
USWK 1-10	175	320	210	490	6.8
USWK 1 1/4-10	175	355	240	500	7.4
USWK 1 1/4-16	175	355	240	500	7.4
USWK 1 1/2-16	266	420	255	610	23.0
USWK 1 1/2-25	266	420	255	610	23.0
USWK 2-25	312	474	290	660	31.0
USWK 2-40	312	474	290	660	31.0



*3-way valve $K_{vs} = \frac{V_{100}}{\sqrt{\frac{\Delta p_{V100}}{100}}}$, where Δp_{V100} — pressure loss at fully opened valve; V_{100} — rated water flow at Δp_{V100} .

Designation key

Series	Connecting diameter	3-way valve [Kvs]*
USWK	3/4"; 1"; 1 1/4"; 1 1/2"; 2"	4; 6; 10; 16; 25; 40

Technical data

	value	USWK 3/4-4	USWK 3/4-6	USWK 1-6	USWK 1-10	USWK 1 1/4-10	USWK 1 1/4-16	USWK 1 1/2-16	USWK 1 1/2-25	USWK 2-25	USWK 2-40	
Circulation pump	-	DAB VA65/180		DAB A50/180XM		DAB A56/180XM		DAB BPH 120/250.40M		DAB BPH 120/280.50T		
Three-way valve regulation mode	-	smooth 0...10 V										
Three-way valve with electric actuator	-	Belimo R317	Belimo R318	Belimo R322	Belimo R323	Belimo R329	Belimo R331	Belimo R338	Belimo R339G	Belimo R348	Belimo R349G	
Three-way valve actuator	-	Belimo LR24A-SR						Belimo NR24A-SR	Belimo SR24A-SR	Belimo NR24A-SR	Belimo SR24A-SR	
Connection	-	Thread						Flange				
Three-way valve nominal diameter	-	DN 20	DN 20	DN 25	DN 25	DN 32	DN 32	DN 40	DN 40	DN 50	DN 50	
Three-way valve K_{vs}	-	4	6.3	6.3	10	10	16	16	25	25	40	
Max. capacity	m ³ /h	2.3	3.0	4.1	6.0	6.8	9.0	11.0	14.0	21.0	27.0	
Max. developed head	kPa	57	57	57	57	62	62	110	110	115	115	
Connecting pipe diameter	inch	3/4"	3/4"	1"	1"	1 1/4"	1 1/4"	1 1/2"	1 1/2"	2"	2"	
Pumped medium temperature	°C	-10...+110						-10...+120				
Max. glycol content in pumped medium	%	30	30	30	30	30	30	30	30	30	30	
Number of pump speeds	-	3	3	3	3	3	3	3	3	3	3	
Phase/ Pump voltage	V	1~230								3~400		
Max. pump power	W	78	78	184	184	271	271	510	510	898	898	

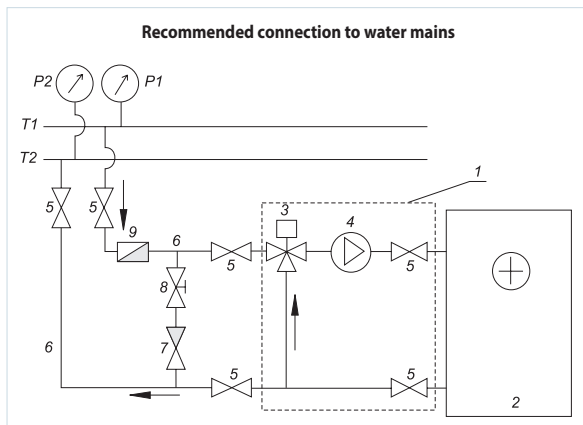

T1 and T2 – supply and return pipeline;
P1 and P2 – manometers for supply and return pipelines in the water mains;

- 1 – USWK (mixing unit);
- 2 – Water heater;
- 3 – Three-way valve with actuator;
- 4 – Circulation pump;
- 5 – Shutoff valve;
- 6 – Supply and return pipeline from water mains to the water heater;
- 7 – Non-return valve;
- 8 – Balancing valve;
- 9 – Coarse filter.

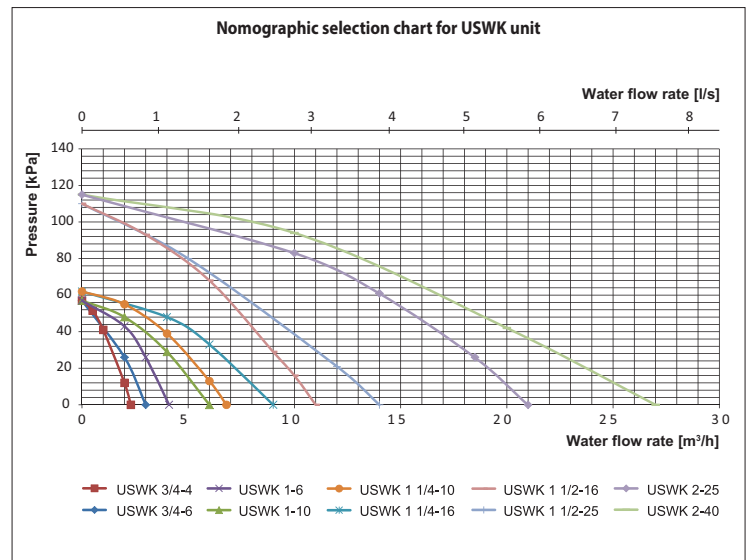

To select the mixing unit according to the nomographic chart, calculate the required heat medium flow through the water heat exchanger and water pressure drop (water head). These parameters are calculated according to the heating/cooling diagrams specifically for each water heat exchanger stated specifically herein.

SH-32 series



Application

The hydraulic U-trap SH-32 is designed for condensate drainage from heat exchangers and coolers in ventilation and air conditioning systems.

The U-trap must be connected to a drain pan pipe F 18 mm.

A mounting example for the SH-32 U-trap

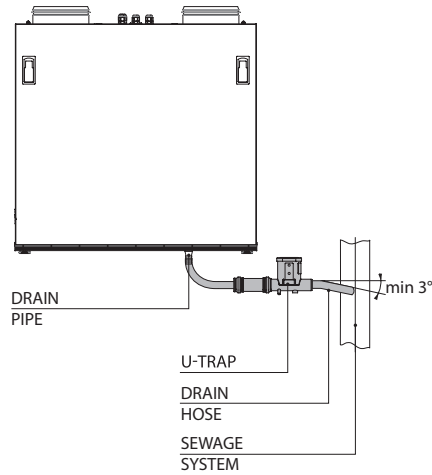

Design

When the condensate is drained from the ventilation unit, it passes the drain pipe through the flexible PVC hose, the connection coupling and reaches the U-trap with the mechanical locking device that does not let sewage system odours out after the hydraulic seal dries out. Then the condensate is moved to the sewage system.

The SH-32 set consists of:

1. Coupling 32/32;
2. Rubber sleeve 32/20;
3. U-trap;
4. PVC hose 15x2 of 1000 mm length.

Overall dimensions:

Type	Dimensions, mm		
	ØD	B	L
SH-32	32	103	1000

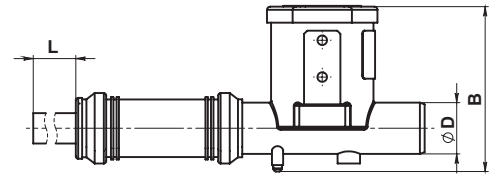

DRAIN PUMP

DN-2



Application

Condensate may form in the heat exchanger during heat recovery. The drain pump provides extraction and discharge of condensate in ventilation systems.

Mounting

The condensate drain pan should only be mounted in a horizontal position. The drain pump can be installed both horizontally and vertically. See the User's manual for more details.

Design

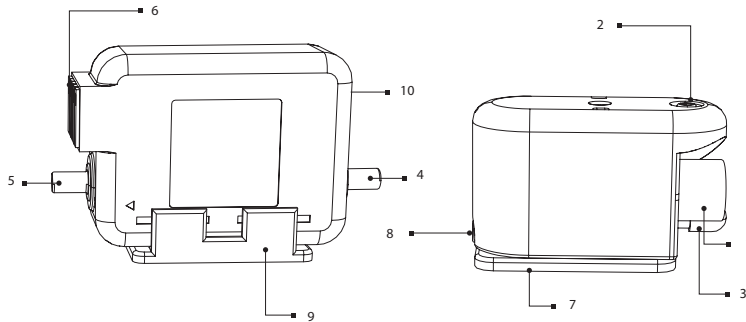

- 1 – condensate water inlet
- 2 – air intake fitting for Ø 4x6 hose
- 3 – condensate outlet fitting
- 4, 8 – fitting for Ø 4x6 connecting hose
- 5 – fitting for a drain pipe
- 6 – removable terminal block
- 7 – mounting plate
- 9 – pump lock
- 10 – removable electric cable socket

Technical data

Air flow [l/h]	7
Water lifting at inlet (evacuation) [m]	2
Water lifting at outlet (delivery) in vertical direction [m]	7
Voltage [V/Hz]	230/50
Noise level [dBA]	21
Power [W]	19
C – NO signal contact parameters [A]	8

Overall dimensions

Model	Dimensions [mm]								
	ØD2	ØD1	A	A1	A2	H	H1	L	L1
DN-2	18	5	68	68	82	55	38	32	30

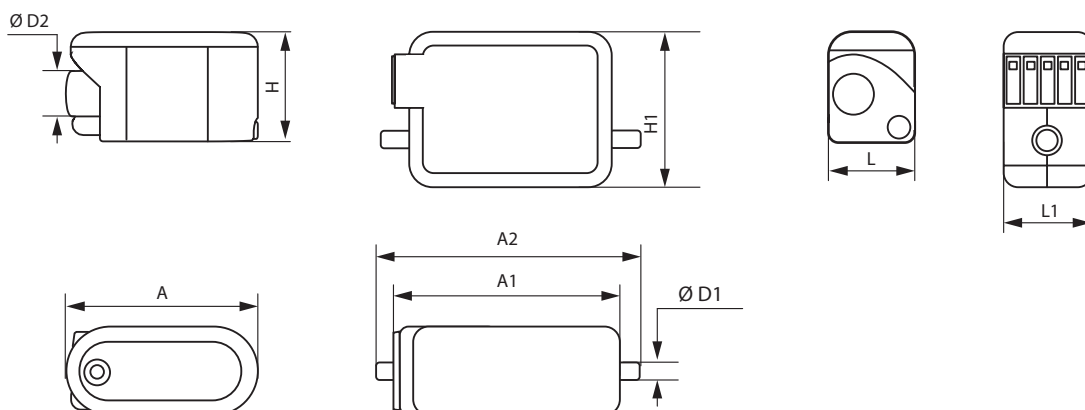

Series
KOM



■ **Applications**

Spring-loaded backdraft damper for round ducts. The damper prevents back draft when the system is off. The blades are opened with air flow and are closed with a spring.

■ **Design**

The damper is made of galvanized steel housing with spring-loaded aluminium blades.

■ **Modifications**

KOMu model is sealed with foamed rubber for noise absorption and extra air tightness.

■ **Mounting**

The damper is connected to round air ducts and fixed with clamps. The blade axis should be in vertical position. Correct air flow direction should be considered.

Overall dimensions

Type	Dimensions [mm]		Mass [kg]
	ØD	L	
KOM 100 KOMu 100	99	80 90	0.18
KOM 125 KOMu 125	124	100 110	0.27
KOM 150 KOMu 150	149	115 125	0.38
KOM 160 KOMu 160	159	120 130	0.42
KOM 200 KOMu 200	199	145 155	0.63
KOM 250 KOMu 250	249	165 175	0.90
KOM 315 KOMu 315	314	190 200	1.31

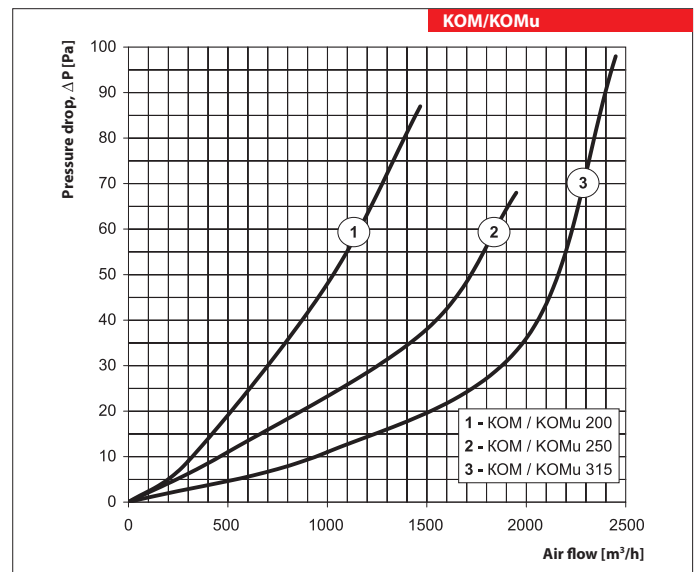
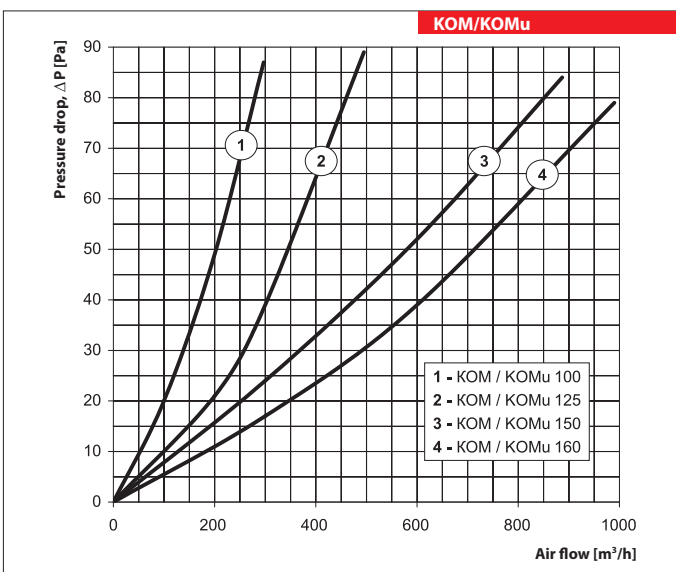
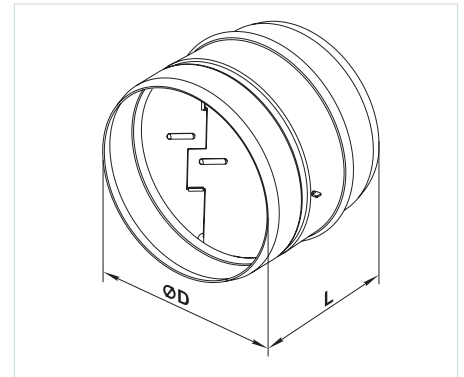

Designation key

Series	Spigot diameter [mm]
KOM/KOMu	100; 125; 150; 160; 200; 250; 315

BACKDRAFT DAMPERS

Series
KOM1



■ **Applications**

Gravity backdraft damper for round air duct. The damper prevents back draft when the system is off.

■ **Design**

The housing and the rotary blade made of galvanized steel. The damper spigots are rubber sealed for airtight connection to the air duct.

The damper is opened by the airflow and is closed when the system is off. The damper handle counterweight enables regulation of the damper opening-closing sensitivity.

■ **Mounting**

Standard spigot connection for round air ducts. The blade axis should be in horizontal position allowing the blade to close by its own weight. Correct airflow direction should be considered.

Overall dimensions

Type	Dimensions [mm]			Mass [kg]
	∅D	B	L	
KOM1 100	99	139	150	0.65
KOM1 125	124	162	170	0.81
KOM1 150	149	194	180	0.97
KOM1 160	159	204	190	1.06
KOM1 200	199	238	220	1.57
KOM1 250	249	290	270	2.2
KOM1 315	314	356	340	3.24
KOM1 355	348	400	400	3.9

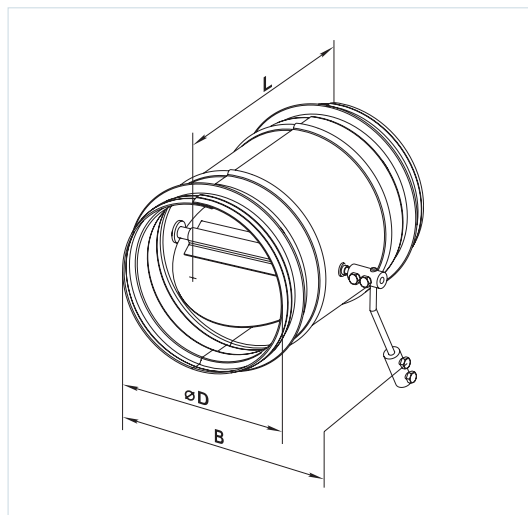

Designation key

Series	Spigot diameter [mm]
KOM 1	100; 125; 150; 160; 200; 250; 315; 355

Series
KOM1



■ **Applications**

Gravity backdraft damper for air flow cut-off in rectangular air duct. The damper prevents back draft when the system is off.

■ **Design**

The housing and the rotary blade are made of galvanized steel. The damper blade is opened by the air pressure and is closed when the system is off.

The damper handle counterweight enables regulation of the damper opening-closing sensitivity.

■ **Mounting**

Standard spigot connection for rectangular air ducts. The blade axis should be in horizontal position allowing the blade to close by its own weight. Correct airflow direction should be considered.

Overall dimensions

Type	Dimensions [mm]								Mass [kg]
	B	B1	B2	B3	H	H1	H2	L	
KOM1 400x200	400	420	440	461	200	220	240	202	2.9
KOM1 500x250	500	520	540	561	200	270	290	202	3.73
KOM1 500x300	500	520	540	561	300	320	340	202	4.1
KOM1 600x300	600	620	640	661	300	320	340	202	4.64
KOM1 600x350	600	620	640	661	350	370	390	202	5.03

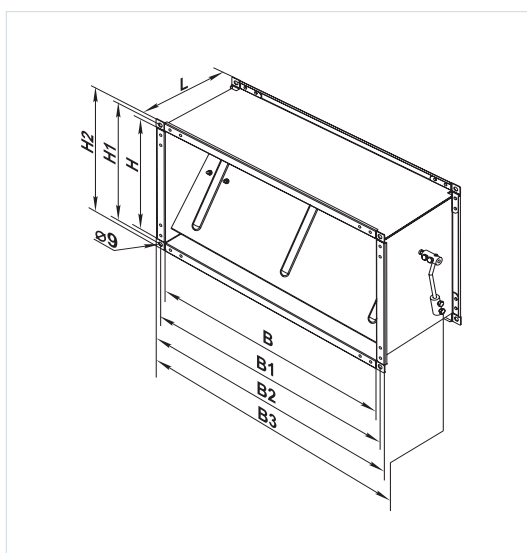

Designation key

Series	Flange dimensions [mm]
KOM 1	400x200; 500x250; 500x300; 600x300; 600x350

AIR DAMPERS

**Series
KR**



Applications

Air damper for air flow control in rectangular air ducts. Compatible with duct sizes 400x200, 500x250, 500x300, 600x300, 600x350 mm.

Design

The housing and the blade made of galvanized steel. Lever with metal handle and fixing clamp let fix the damper position with a butterfly bolt.

Mounting

Standard connection flange for rectangular air ducts or other ventilation system components. Flanges should be connected with galvanized bolts and clamps.

Overall dimensions

Type	Dimensions [mm]								Mass [kg]
	B	B1	B2	B3	H	H1	H2	L	
KR 400x200	400	420	440	460	200	220	240	202	3.0
KR 500x250	500	520	540	560	250	270	290	202	3.8
KR 500x300	500	520	540	560	300	320	340	202	3.1
KR 600x300	600	620	640	660	300	320	340	202	4.2
KR 600x350	600	620	640	660	350	370	390	202	5.1

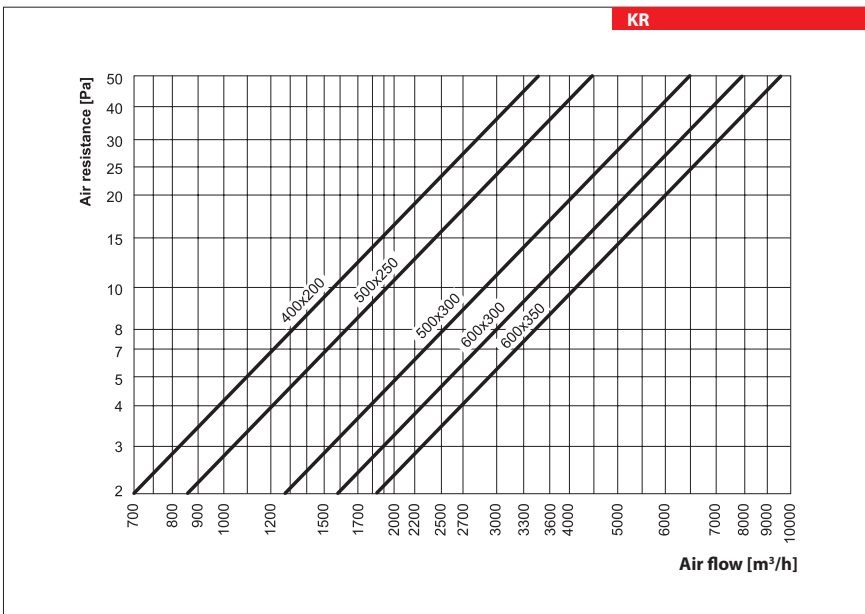
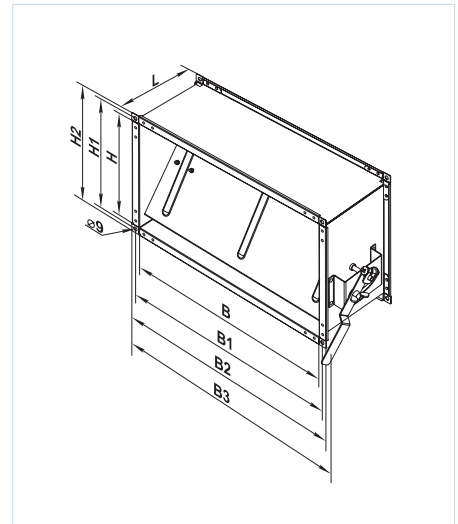

Designation key

Series	Flange dimensions (WxH) [mm]
KR	400x200; 500x250; 500x300; 600x300; 600x350

Series
KR



■ **Application**

Air damper for air flow control in round air ducts. Compatible with duct sizes: Ø 80, 100, 125, 150, 160, 200, 250, 315, 355, 400, 450, 500, 550 and 630 mm.

■ **Design**

The housing and the blade made of galvanized steel.

Lever with metal handle and fixing clamp. In closed position about 10 % of cross section is left open. Connection spigots with rubber sealing gaskets.

■ **Mounting**

The damper is connected to round air ducts and fixed with clamps.

Overall dimensions

Type	Dimensions [mm]			Mass [kg]
	ØD	B	L	
KR 80	79	140	200	0.57
KR 100	99	170	200	0.68
KR 125	124	195	200	0.82
KR 150	149	220	200	0.95
KR 160	159	230	200	1.01
KR 200	199	270	200	1.29
KR 250	249	320	200	1.64
KR 315	314	385	240	2.51
KR 355	348	425	240	2.84
KR 400	399	470	240	3.38
KR 450	449	520	240	3.94
KR 500	499	570	240	5.72
KR 550	549	620	240	6.47
KR 630	629	700	240	7.76

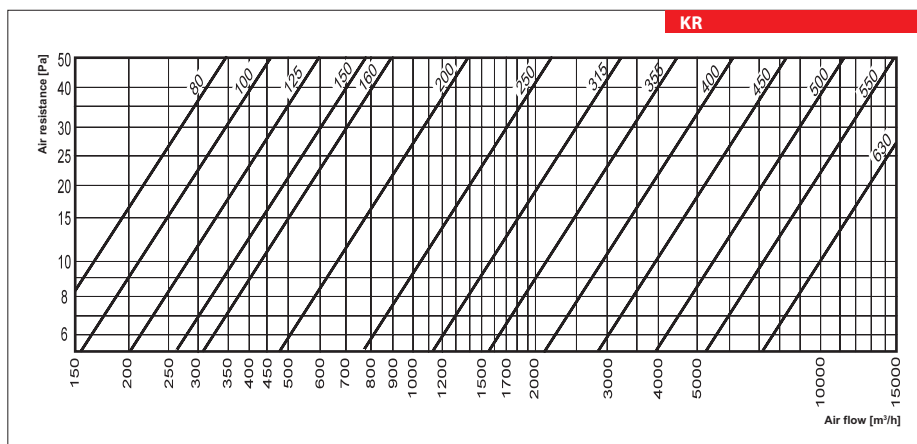
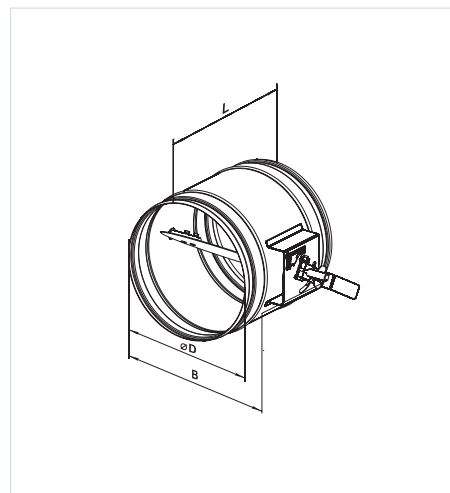

Designation key

Series	Spigot diameter [mm]
KR	80; 100; 125; 150; 160; 200; 250; 315; 355; 400; 450; 500; 550; 630

AIR DAMPERS

**Series
KRV**



Application

Air damper for air flow cut-off in round air ducts. Compatible with duct sizes: Ø 80, 100, 125, 150, 160, 200, 250, 315, 355, 400, 450, 500, 550 and 630 mm.

Design

The housing and the blade made of galvanized steel. Connecting spigots with rubber sealing gaskets. Universal shaft for automatic actuator (available upon

separate order). Compatible actuators are shown in the table below.

Mounting

The damper is connected to round air duct and fixed with clamps.

Compatible Belimo actuators

Model	Actuator drive			
	Electric actuator, 230 V	Electric actuator with spring return, 230 V	Electric actuator, 24 V	Electric actuator with spring return, 24 V
KRV 80	CM230/LM230A	TF230	CM24 / LM24A	TF24
KRV 100			CM24 / LM24A	TF24
KRV 125	CM230/LM230A	TF230	CM24 / LM24A	TF24
KRV 150			CM24 / LM24A	TF24
KRV 160	CM230/LM230A	TF230	CM24 / LM24A	TF24
KRV 200			CM24 / LM24A	TF24
KRV 250	CM230/LM230A	TF230	CM24 / LM24A	TF24
KRV 315			CM24 / LM24A	TF24
KRV 355	CM230/LM230A	TF230	CM24 / LM24A	TF24
KRV 400			CM24 / LM24A	TF24
KRV 450	CM230/LM230A	TF230	CM24 / LM24A	TF24
KRV 500			CM24 / LM24A	TF24
KRV 550	CM230/LM230A	TF230	CM24 / LM24A	TF24
KRV 630			CM24 / LM24A	TF24

Overall dimensions

Type	Dimensions [mm]				Mass [kg]
	ØD	B	L	H	
KRV 80	79	190	200	170	0.6
KRV 100	99	220	200	180	0.72
KRV 125	124	245	200	195	0.86
KRV 150	149	270	200	205	1.01
KRV 160	159	280	200	210	1.07
KRV 200	199	320	200	230	1.33
KRV 250	249	370	200	255	1.68
KRV 315	314	435	240	-	2.44
KRV 355	348	475	240	-	2.75
KRV 400	399	520	240	-	3.26
KRV 450	449	570	240	-	3.78
KRV 500	499	620	240	-	5.55
KRV 550	549	670	240	-	6.27
KRV 630	629	750	240	-	7.49

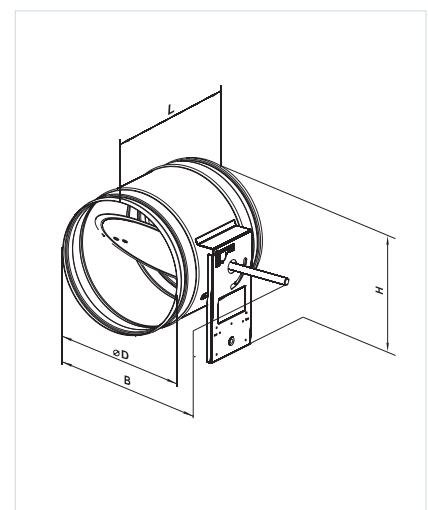
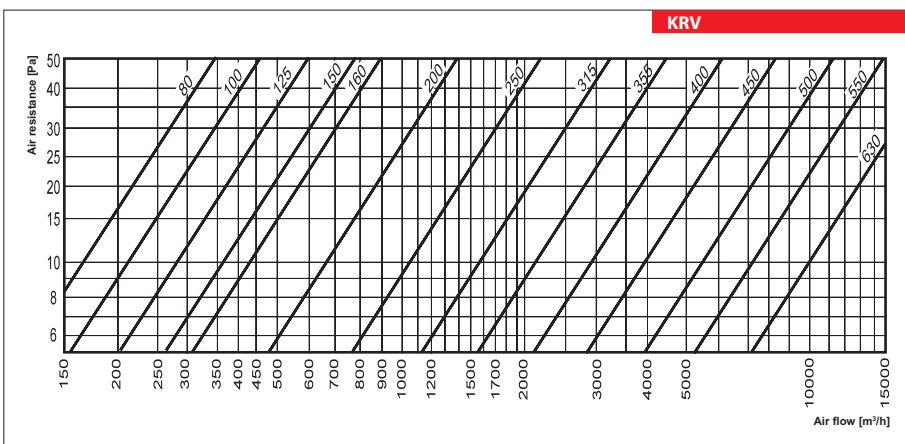

Designation key

Series	Spigot diameter [mm]
KRV	80; 100; 125; 150; 160; 200; 250; 315; 355; 400; 450; 500; 550; 630

Accessories



Series
RRV



■ **Application**

Multi-blade damper for air flow control or cut-off in rectangular air ducts.

Compatible with duct sizes 400x200, 500x250, 500x300, 600x300, 600x350, 700x400, 800x500, 900x500 and 1000x500 mm.

■ **Design**

The housing made of galvanized steel. The aluminium blades driven by plastic gearwheels. Lever with removable metal handle and fixing clamp.

Universal shaft for automatic actuator. Compatible

actuators are shown in the table below (available upon separate order). For actuator connection the metal handle should be removed from the shaft.

■ **Mounting**

Standard connection flange for rectangular air ducts or other ventilation system components.

Flanges should be connected with galvanized bolts and clamps.

Overall dimensions

Type	Dimensions [mm]								Mass [kg]
	B	B1	B2	B3	H	H1	H2	L	
RRV 400x200	400	420	440	540	200	220	240	170	3.5
RRV 500x250	500	520	540	640	250	270	290	170	4.2
RRV 500x300	500	520	540	640	300	320	340	170	4.9
RRV 600x300	600	620	640	740	300	320	340	170	5.4
RRV 600x350	600	620	640	740	350	370	390	170	5.7
RRV 700x400	700	720	740	840	400	420	440	170	7.7
RRV 800x500	800	820	840	940	500	520	540	170	8.8
RRV 900x500	900	920	940	1040	500	520	540	170	9.6
RRV 1000x500	1000	1020	1040	1140	500	520	540	170	10.3

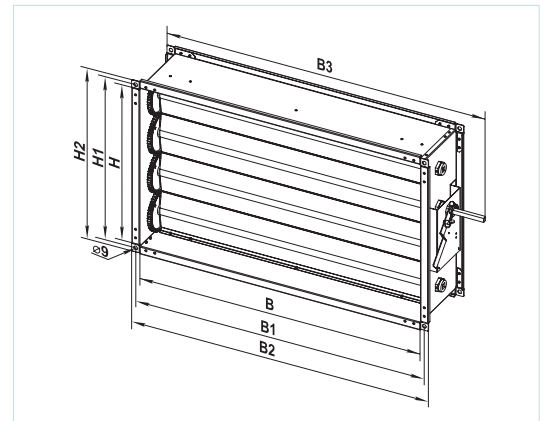

Compatible Belimo actuators

Model	Actuator type			
	Electric actuator, 230 V	Spring return electric actuator, 230 V	Electric actuator, 24 V	Spring return electric actuator, 24 V
RRV 400x200	CM230/ LM230A	TF230/LF230	CM24/ LM24A	TF24/LF24
RRV 500x250				
RRV 500x300				
RRV 600x300				
RRV 600x350	LM230A	LF230	LM24A	LF24
RRV 700x400				
RRV 800x500				
RRV 900x500				
RRV 1000x500				

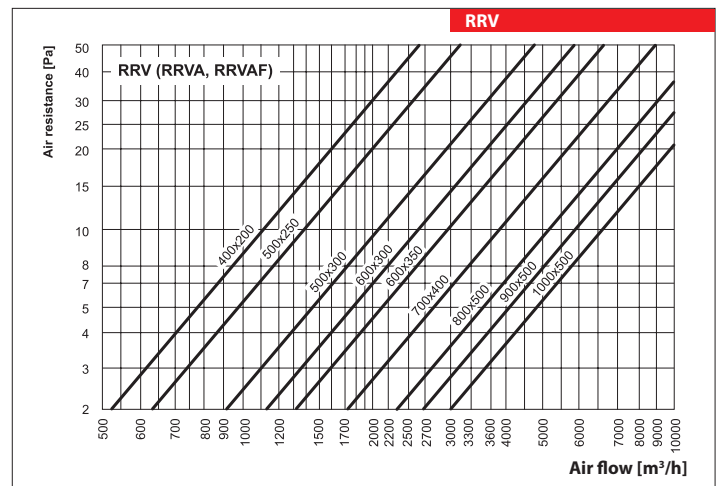

Designation key

Series	Flange dimensions [mm]
RRV	400x200; 500x250; 500x300; 600x300; 600x350; 700x400; 800x500; 900x500; 1000x500

Accessories



page 496



page 497



page 498



page 499

Series
VVGF



Series
VVG



■ **Applications**

Flexible connectors are designed to exclude the vibration transmission from fans or ventilating units to the air duct

as well as for the thermal distortion compensation within the air duct. Applied in ventilation systems with the transferred air temperature over the range of -40 °C to

+80 °C. Compatible with round Ø 100 up to 500 mm air ducts for VVG models and from Ø 200 up to 630 mm air ducts for VVGF models.

■ **Design**

Flexible connectors are two flanges made of galvanized sheet steel interconnected by vibration-isolating material made of polyethylene tape reinforced with polyamide fiber. The connectors are not designed for mechanical load and cannot be used as a part of load-bearing construction.

■ **Mounting**

Mounting of flexible connector into the ventilation system is effected by means of end flanges fixing to the mating flanges in the ventilation system. Fixing is performed by means of galvanized bolts and brackets.

Overall dimensions

Type	Dimensions [mm]		Mass [kg]
	ØD	L	
VVG 100	101	130	0.14
VVG 125	126	130	0.17
VVG 140	139.5	130	0.2
VVG 150	151	130	0.21
VVG 160	161	130	0.22
VVG 180	179.5	130	0.26
VVG 200	201	130	0.28
VVG 225	222.5	130	0.31
VVG 240	238.5	130	0.34
VVG 250	251	130	0.35
VVG 280	279.5	130	0.38
VVG 315	316	130	0.44
VVG 355	356	130	0.50
VVG 400	401	130	0.56
VVG 450	451	130	0.64
VVG 500	501	130	0.71

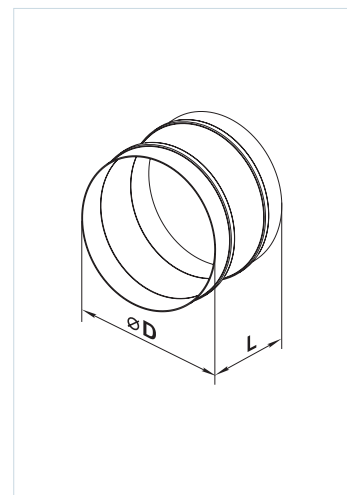

Type	Dimensions [mm]				Mass [kg]
	ØD	ØD1	ØD2	L	
VVGF 200	205	235	255	160	1.29
VVGF 250	260	286	306	160	1.21
VVGF 300	310	356	382	160	1.90
VVGF 350	362	395	421	160	2.06
VVGF 400	412	438	465	160	2.57
VVGF 450	462	487	515	160	2.88
VVGF 500	515	541	570	160	3.81
VVGF 550	565	605	636	160	4.53
VVGF 630	645	674	715	160	5.13

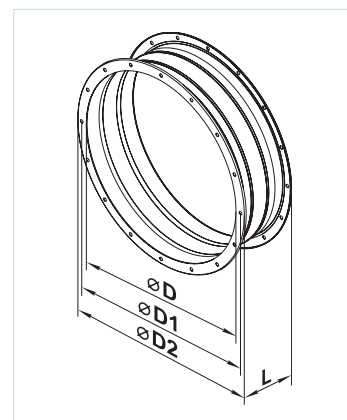

Designation key

Series	Spigot diameter [mm]
VVG	100; 125; 140; 150; 160; 180; 200; 225; 240; 250; 280; 315; 355; 400; 450; 500

Series	Spigot diameter [mm]
VVGF	200; 250; 300; 350; 400; 450; 500; 550; 630

Series
VVG



■ **Applications**

Flexible connectors are designed to exclude the vibration transmission from fans or ventilating units to the air duct as well as for the thermal distortion compensation within the air duct. Applied in ventilation systems with the transferred air temperature over the range of -40 °C to +80 °C.

■ **Design**

Flexible connectors are two flanges made of galvanized sheet steel interconnected by vibration-isolating material made of polyethylene tape reinforced with polyamide fiber. The connectors are not designed for mechanical load and cannot be used as a part of load-bearing construction.

■ **Mounting**

Mounting of flexible connector into the ventilation system is effected by means of end flanges fixing to the mating flanges in the ventilation system. Fixing is performed by means of galvanized bolts and brackets.

Overall dimensions

Type	Dimensions [mm]						Mass [kg]
	B	B1	B2	H	H1	H2	
VVG 400x200	400	420	440	200	220	240	1.1
VVG 500x250	500	520	540	250	270	290	1.4
VVG 500x300	500	520	540	300	320	340	1.6
VVG 600x300	600	620	640	300	320	340	1.82
VVG 600x350	600	620	640	350	370	390	1.95
VVG 700x400	700	720	740	400	420	440	2.4
VVG 800x500	800	820	840	500	520	540	2.8
VVG 900x500	900	920	940	500	520	540	3.0
VVG 1000x500	1000	1020	1040	500	520	540	3.2

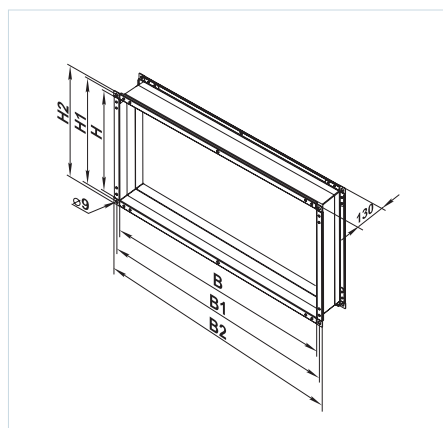

Designation key

Series	Flange dimensions (WxH) [mm]
VVG	400x200; 500x250; 500x300; 600x300; 600x350; 700x400; 800x500; 900x500; 1000x500

A22



A22 WiFi



Application

The A22/A22 WiFi control panels are used for control of industrial and domestic air handling units with an A21 automation system.

Installation and connection

The A22/A22 WiFi control panels are suitable for wall flush and wall surface mounting. Mounting boxes for wall surface mounting and wall flush mounting are included in the delivery set. Connection of the control panel is carried out according to the User's manual of the unit.

Technical data

Wired A22 control panel (connected to the unit with a cable)

	A22
Voltage [V]	24
Maximum current [A]	0.025
Cable type	4x0.25 mm ²
Temperature range [°C]	from +10 up to +45
Humidity range [%]	from 10 % up to 80 % (no condensation)
SEC class	IP40

Wireless A22 WiFi control panel (connected to the unit via Wi-Fi)

	A22 WiFi
Supply voltage, 50 (60) Hz [V]	110-230
Maximum current [A]	0.012
Cable type	2x0.35 mm ²
Temperature range [°C]	from +10 up to +45
Humidity range [%]	from 10 % up to 80 % (no condensation)
Casing material	Plastic
Sensor surface material	Glass
SEC class	IP40
Weight [g]	190

Wi-Fi data

Standard	IEEE 802.11 b/g/n
Frequency band [GHz 2.4]	2.4
Transmission power [mW] (dBm)	100 (+20)
Network	DHCP
WLAN safety	WPA, WPA2

Overall dimensions

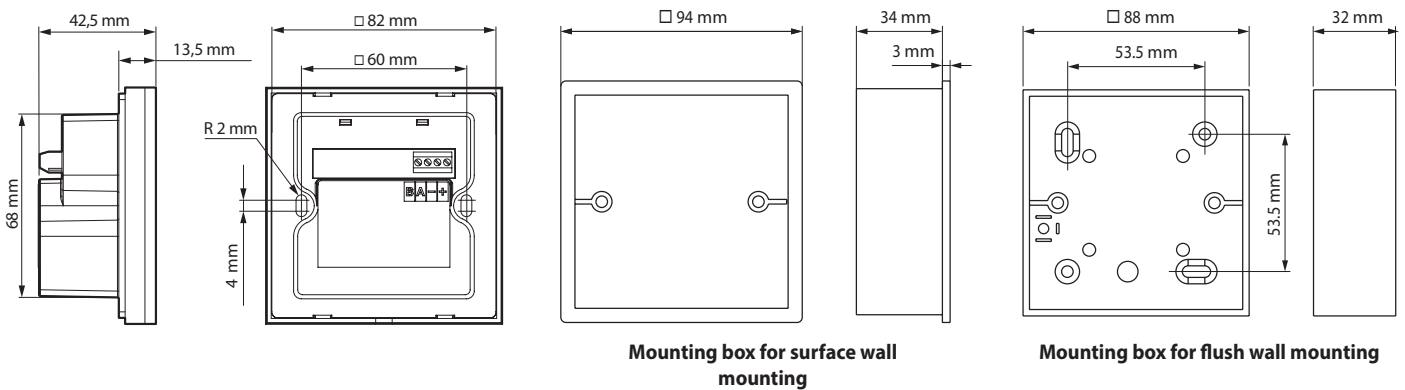

A25



■ Application

The A25 control panel with a sensor display is used for control of industrial and domestic air handling units with an A21 automation system.

■ Installation

Connection and mounting of the control panel are carried out according to the User's manual of the unit.

■ Technical data

	A25
Voltage DC [V]	12-32
Current at 24 VDC [A]	0.1
Power cable type (10 m)	4x0.25 mm ²
Temperature range [°C]	from +10 up to +45
Humidity range [%]	from 10 % up to 80 % (no condensation)
SEC class	IP20

■ Overall dimensions

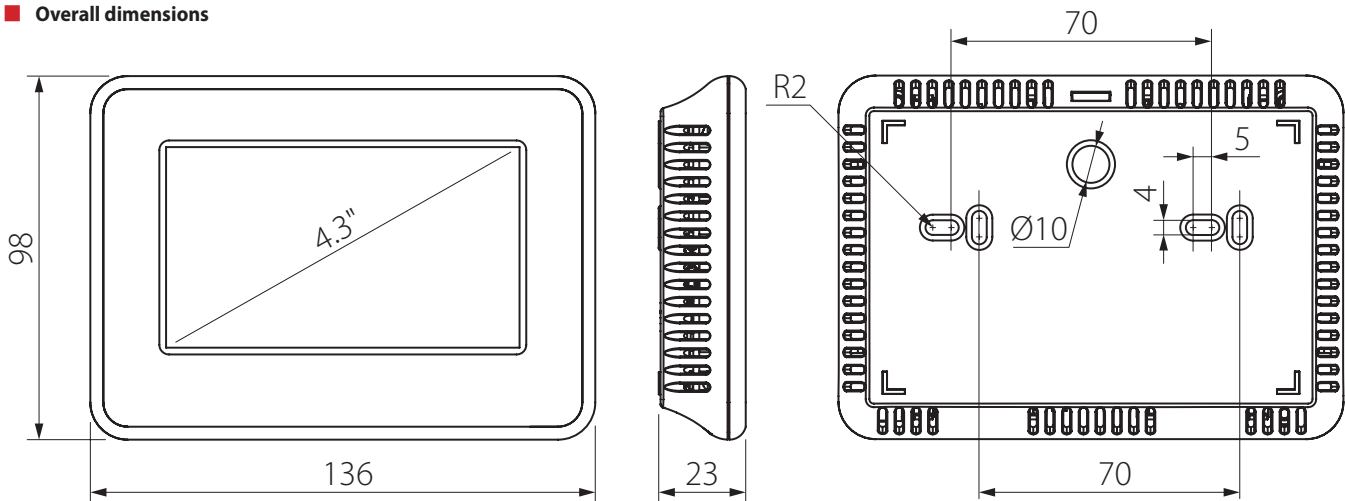

Electro-mechanical humidistats

HR-S



■ Purpose

The humidistat is designed for controlling humidification and/or dehumidification in ventilation, air conditioning and heating systems. Can also be used to alarm when the humidity exceeds or falls below a pre-set level.

■ Design

The single-stage humidistat HR-S uses a synthetic element as sensor medium. The synthetic element stretches as the humidity increases and shrinks as the humidity decreases.

■ Mounting

The humidistat is designed for indoor mounting on the wall surface.

Technical data

Switch contact	250 V AC, 5 A
Moisture [%]	20-90 %
Casing material	Polycarbonate
Temperature range [°C]	0-40
Mounting	Wall surface mounting
Ingress protection	IP30
Dimensions [mm]	86x86x30

Humidistat wiring diagram

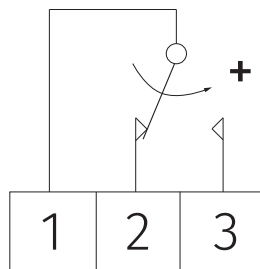

Humidification
Dehumidification

Closing contact between terminals 1 and 2
Closing contact between terminals 1 and 3

ELECTRIC ACTUATORS

Series
BELIMO
TF24/TF230



Application

The TF series actuators with actuating torque 2 Nm are designed for controlling air dampers with cross section up to 0.4 m² installed in various ventilation and air conditioning systems and performing protection functions, as freezing protection, smoke detection, etc.

Design

The actuator moves the damper to its operating position while tensioning the return spring at the same time. In case of power supply cut-off, the damper moves back to its safe position by the spring energy. The actuator is installed directly on the damper axis and locked with a special spindle clamp to prevent its turning-through. The actuator overload protection stops the actuator once it reaches the end positions. The turning angle may be adjusted by a mechanical end stop.

Technical data

	TF24	TF230
Voltage	24 AC 50/60 Hz, 24 DC	230 V~50/60 Hz
Nominal voltage range [V]	19.2...28.8 AC 21.6...28.8 DC	85...265 AC
Rated power [VA]	4 (max. I 5.8 A at t = 5 ms)	4 (max. I 150 mA at t = 10 ms)
Power consumption in operation/at rest [W]	2/1.3	2/ 1.3
Connecting cable	1 m long, 2 x 0.75 mm ²	
Rotation direction	determined by L/R positioning	
Torque (motor/spring) [Nm]	2, nominal voltage/2	
Rotation angle:	max. 95°, adjustable 37...100 % with a mechanical end stop	
Running time (motor/spring) [s]	40...75 (0...2 Nm)/< 25 at -20...50 °C	
Service life	60 000 switching operations	
Ingress protection	IP42	
Electrical protection class	III low voltage II totally insulated	
Operation temperature [°C]	-30...+50	
Storage temperature [°C]	-40...+80	
Ambient humidity	95 %, no condensation	
Noise level (motor/ spring) [dBA]	50 /~62	
Maintenance	not required	
Mass [kg]	0.6	

Wiring diagram

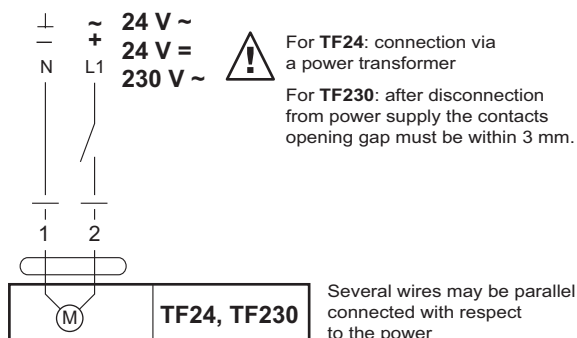

Overall dimensions [mm]

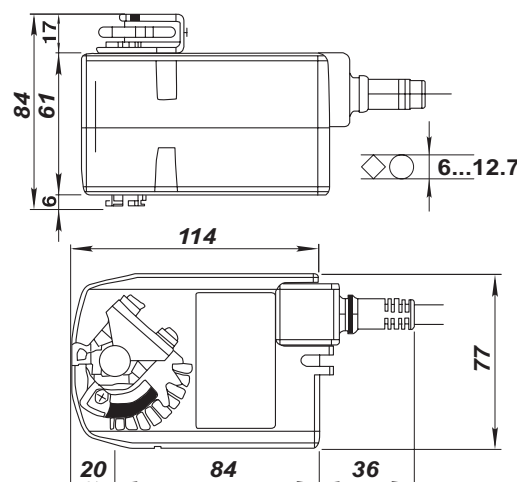

Series
DPWC11200



■ **Features**

The DPWC humidity sensor is intended for humidification control in air ventilation, air conditioning and heating systems.

■ **Design**

The DPWC11200 humidity and temperature sensor has 2 analogue outputs: 0-10 V and 4-20 mA. An analogue output provides for stepless fan speed control (requires an EC-motor fan or an extra speed controller with an output 0...10 V, for example, VFED). With stepless control the fan speed is changed in proportion to the humidity level.

■ **Mounting**

The sensor is mounted onto a wall in the serviced space. The unit is powered from a 24 V AC/DC low-current electric mains.

Technical data

Parameters	Values
Power source	8-30 V DC/12-24 V AC
Analogue outputs	0-10 V and 4-20 mA
Temperature measurement precision	±1,2 °C
Humidity measurement precision	±3 % RH
Operating conditions	-10-60 °C; 10-90 % humidity without condensate
Protection class	IP30
Dimensions [mm]	127x80x30

VOC SENSOR

Series
DPWQ30600



■ **Use**

Self-calibrating sensor DPWQ30600 VOC with a microprocessor control for air quality control. Qualitative assessment of air saturation with contaminants (cigarette smoke, exhaled air, solvent and detergent vapours). The sensor sensitivity can be adjusted with regards to the expected maximum level of air pollution. Enables on-demand ventilation which results in considerable energy savings as air is exchanged only upon reaching the pre-set level of pollution.

■ **Design**

VOC sensor has 2 analogue outputs: 0-10 V and 4-20 mA. An analogue output provides for stepless fan speed control (requires an EC-motor fan or an extra speed controller with an output 0...10 V, for example, VFED). With stepless control the fan speed is changed in proportion to air quality changes.

■ **Mounting**

The sensor is mounted onto a wall or a mounting box inside the serviced space.

The unit is powered from a 24 V AC/DC low-current electric mains.

Technical data

Parameters	Values
Power source	24 V AC/DC
Gas analyser	VOC sensor
Measurement range	0-100 % air quality
Output signal	0-10 V
Measurement precision	±20 %
Operating conditions	0-50 °C; 10-90 % relative humidity without condensate
Protection class	IP30
Dimensions [mm]	79x81x26

Duct temperature sensors with a terminal box

KDT-MK

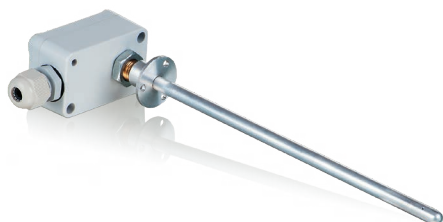

■ **Application**

The duct temperature sensors are designed for installation in the air duct and temperature measurement of the air flow in the ventilation and air conditioning systems.

■ **Design**

The sensing element, NTC thermometer resistor, is enclosed in the aluminium sleeve. The thermometer resistor electric resistor depends on the temperature, the non-linear resistance. Connection of the sensor to the controller is double-wired, regardless of polarity.

The KDT-MK sensor delivery set includes a mounting flange with a fixing screw for its fixation to the air duct wall.

The sensors are supplied with a 2.5 m connecting cable. The immersion depth is adjusted for 100, 150, 200 or 400 mm.

■ **Mounting**

Fixation with screws to the air duct wall by means of the flange with the sensing element located the air stream.

Technical data

	KDT-MK
Temperature measuring range [°C]	-30...+60
Voltage [V]	≤ 5 DC *
Output	resistance
Electric connection	double-wire, cross section 2x0.25 mm ²
Relative humidity	up to 90 %, no condensation
Protection rating	IP54
Electrical appliance class	III

*Maximum current generated through the sensor by the applied voltage is 2 mA.

Overall dimensions:

Type	L [mm]
KDT-MK 100	100
KDT-MK 150	150
KDT-MK 200	200
KDT-MK 400	400

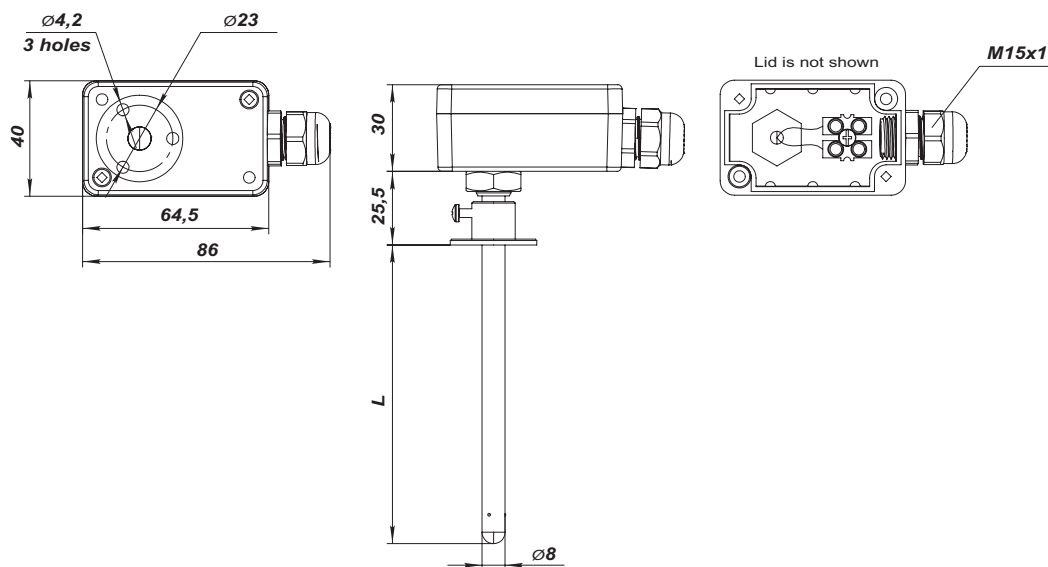

Duct temperature sensors with a terminal box **KDT2-MK**

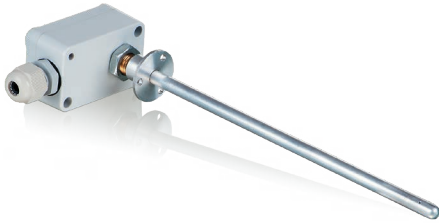

■ Application

The duct temperature sensors are designed for installation in the air duct and temperature measurement of the air flow in the ventilation and air conditioning systems.

■ Design

The sensor consists of the integrated circuit chip located inside the plastic casing. This sensor type has a linear transfer characteristics of output voltage to temperature and a three-wire connection to power mains.

This sensor type is not compatible with resistance

sensors. During electric connections the polarity of the outputs connected to the inputs of the air handling units must be considered.

The KDT2-MK sensor delivery set includes a mounting flange with a fixing screw for its fixation to the air duct wall. The sensors are supplied with a 2.5 m connecting cable. The immersion depth is adjusted for 100, 150, 200 or 400 mm.

■ Mounting

Fixation with screws to the air duct wall by means of the flange with the sensing element located the air stream.

Technical data

	KDT2-MK
Temperature measuring range [°C]	-30...+60
Voltage [V]	2,7...10
Output resistance [Ohm]	800
Electric connection	three-wire, cross section 3x0.25 mm ²
Relative humidity	up to 90 %, no condensation
Protection rating	IP54
Electrical appliance class	III

Overall dimensions:

Type	L [mm]
KDT2-MK 100	100
KDT2-MK 150	150
KDT2-MK 200	200
KDT2-MK 400	400

Wiring diagram

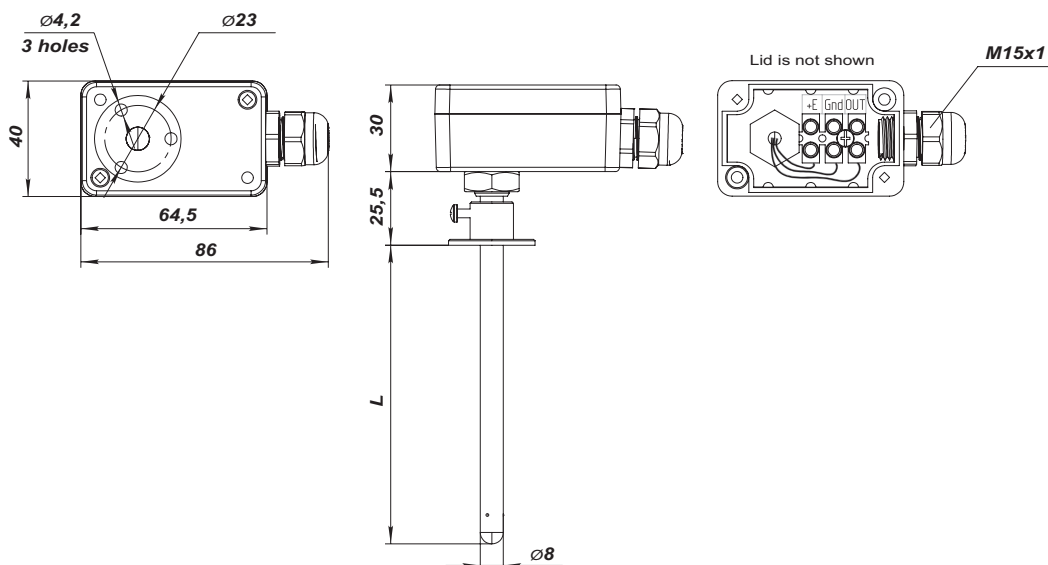
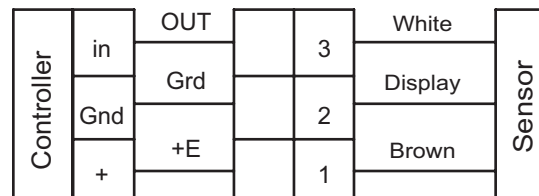

Serie DPWQ40200



■ Anwendung

Self-calibrating sensor with microprocessor control for measuring carbon dioxide concentration in the air within the range from 0 to 2,000 million⁻¹ (parts per million).

■ Design

CO₂ sensor has 2 analogue outputs: 0-10 V and 4-20 mA. An analogue output provides for stepless fan speed control (requires an EC motor fan or an additional fan speed controller with input 0 ... 10 V,

for example, VFED). With stepless control the fan speed is changed in proportion to carbon dioxide concentration changes. The CO₂ dioxide concentration in the air is measured by means of a non-dispersive infrared analyser (NDIR).

■ Mounting

The sensor is mounted onto a wall or a mounting box inside the serviced space. The unit is powered from a 24 V AC/DC low-current electric mains.

Technical data

Parameters	Values
Power source	24 V AC/DC
Gas analyser	optical (NDIR)
CO ₂ measurement range	0-2,000 million ⁻¹ (parts per million) of CO ₂
CO ₂ output signal	0-10 V
CO ₂ measurement precision	± 30 million ⁻¹ (parts per million), ± 5 % of maximum value
Operating conditions	0-50 °C; 10-90 % relative humidity without condensate
Protection class	IP55
Dimensions [mm]	95x97x30

CO₂ SENSORS

CO₂ sensor
CO2-1



CO₂ sensor
CO2-2



■ **Application**

The sensor is designed for indoor carbon dioxide concentration measurement and respective air flow regulation through the control output signal to the fan. Air flow control based on CO₂ concentration is an efficient energy saving solution.

■ **Design and compatibility**

The sensor has two separate outputs: a normally opened dry relay contact and an analogue output 0...10 V (this output is adjustable for 2...10 V/0...20 mA/4...20 mA).

■ **Modifications**

The sensor is available in two modifications: CO2-1 and CO2-2. The CO2-1 model incorporates LED lights for CO₂ concentration and operation buttons indicating the level of three operation modes.

■ **Mounting and power supply**

The sensor is designed for wall surface mounting. 24 VAC low current power supply. If power supply 24 V is not available, connect the TRF plug that is offered as an accessory.

■ **Accessories**

Power supply unit is applied for connection of the sensor to 220 V (model **TRF-220/24-1,6**) or 120 V (**TRF-120/24-1,6**) AC power mains.



Technical data

Parameters	Value
Power supply/consumption	24 VAC (50/60 Hz ± 10 %), 24 VDC/1.6 W Max
Gas detection analyzer	Non-dispersive infrared detector (NDIR) with self-calibration system
CO ₂ measuring range	0–2,000 ppm (parts per million)
Accuracy at 25 °C, 2,000 ppm	±30 ppm + 3 % of reading
Response time	max. 2 min
Warm up time for each turning-on	2 hours (first time), 2 minutes (operation)
Analogue output	0–10VDC (default), 4–20mA selectable by jumpers
On/Off output	1X2A switch load Four set points selectable by jumpers
6 LED lights for CO ₂ concentration indication (for model CO2-1)	1st green indicator lights when CO ₂ concentration is below 600 ppm; 1st and 2nd green indicators light when CO ₂ concentration is 600–800 ppm; 1st yellow indicator lights when CO ₂ concentration is 800–1200 ppm; 1st and 2nd yellow indicators light when CO ₂ concentration is 1200–1400 ppm; 1st red indicator lights when CO ₂ concentration is 1400–1600 ppm; 1st and 2nd red indicators light when CO ₂ concentration is above 1600 ppm
Operating conditions/storage recommendations	0–50 °C; 0–95 % RH non condensing/0–50 °C
Mass/Dimensions	0.120 kg/100 mm x 80 mm x 30 mm

KH-1

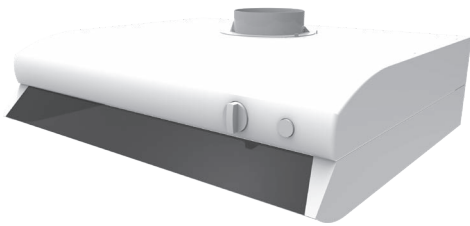

■ Application

The kitchen exhaust hood is designed to clean air from combustion products, fumes, odors that form during cooking in the kitchen.

■ Operating logic

When the kitchen hood is turned on, the valve is opened, the signal is sent to the unit and it boosts to the high speed.

■ Design

The kitchen exhaust hood is equipped with a lighting and a polyester filter.

■ Installation

The mounting accessories and screws are included with the unit. The kitchen exhaust hood is supplied with a cable and a grounded power connector. Installation is carried out according to the unit manual.

Technical Data

Width, mm	600
Electrical connection, V	230
Lighting, V	11

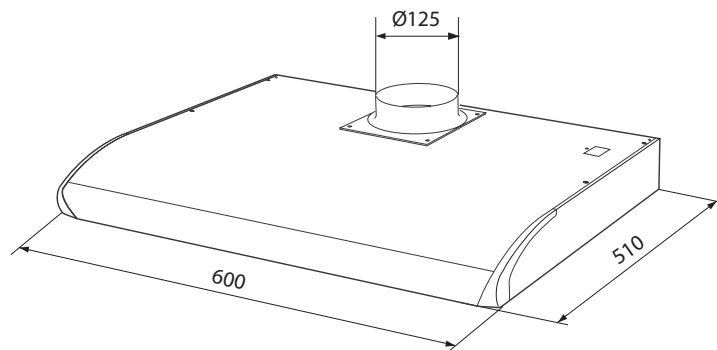

Application examples

The KH-1 kitchen hood can be connected directly to the VUTR 200 VE EC A17/A18 unit.





VENTS

WORLD VENTILATION LEADER

Air handling units

ventilation systems

www.ventilation-system.com

VENTS reserves the rights to modify any of its products' features, designs, components and specifications at any time and without notice to maintain the development and quality of manufactured goods.

2023-01



HVI
MEMBER



CORRESPONDING MEMBER
EUROVENT