

AIRVENTS



Premium line of commercial
heat recovery air handling units

CONTENTS

| | |
|------------------------------------|----|
| HEAT RECOVERY VENTILATION UNIT RH | 6 |
| HEAT RECOVERY VENTILATION UNIT RV | 10 |
| HEAT RECOVERY VENTILATION UNIT RP | 13 |
| HEAT RECOVERY VENTILATION UNIT CFP | 16 |
| HEAT RECOVERY VENTILATION UNIT CFH | 19 |
| HEAT RECOVERY VENTILATION UNIT CFV | 23 |

To provide buildings with the best possible balance of energy efficiency, air quality and comfort, VENTS offers standard air handling units with simplified on-site installation and proven, tested performance. Our air handling solutions deal with such issues as temperature, humidity, pressure control, energy recovery and air filtration.

ERV/HRV WITH ROTARY HEAT EXCHANGER

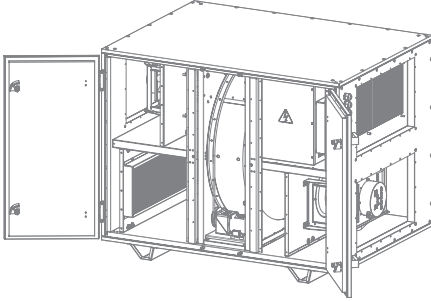

RH
Double-deck units 1500–6000 m³/h

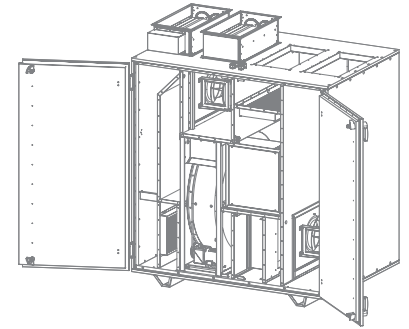

RV
Low-footprint units with vertical outlets 1500–3500 m³/h

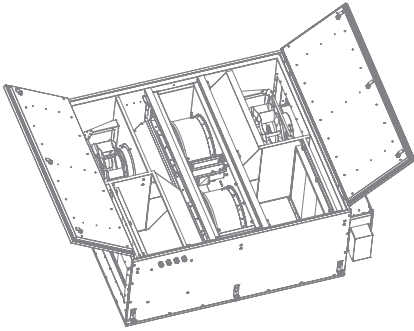

RP
Ceiling-mounted units 1500–2500 m³/h

HRV WITH COUNTER-FLOW PLATE HEAT EXCHANGER

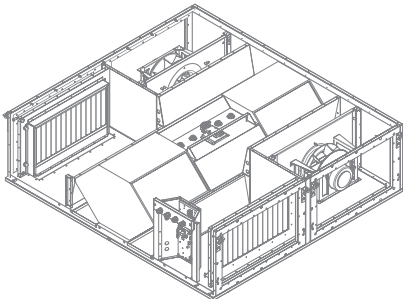

CFP
Ceiling-mounted units 1500–3500 m³/h

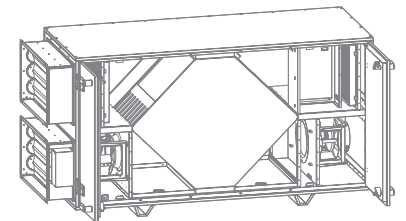

CFH
Double-deck units 1500–6000 m³/h

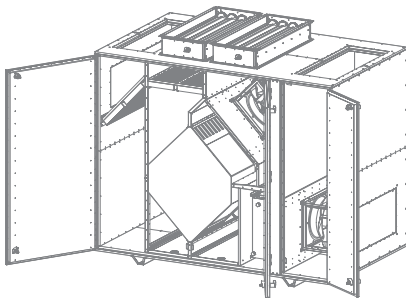

CFV
Low-footprint units with vertical outlets 1500–6000 m³/h

MAIN FEATURES



- Counter-flow aluminum plate heat exchanger or rotary heat exchanger class H1 (DIN EN 13053)
- High-efficiency EC fans, backward-curved, external rotor
- Integrated automatic dampers
- Integrated plug-and-play controls
- Automatic full-size bypass
- Insulated double-skin frameless casing
- ECO-Design'18 compliant
- Web-interface, MODBUS, outputs for optional DX or Hydronic cooling/heating
- Complete set of accessories: silencers, VAV, CAV, etc.
- Operation by RH/CO₂/temperature/constant pressure/timer schedule
- Outdoor installation with outdoor mounting kit (optional)

CONTROLS

CAREL



- Supplied units come with "Plug-&Play" control system based on Carel programmable controller. Depending on the unit configuration, the system is fitted with 3 temperature sensors: outside, supply, and exhaust air temperature; return water temperature sensor and frost protection relay for water heater configuration; overheating protection relay for electric heater configuration. Standard controller outputs allow to connect various additional sensors. The list of the optional sensors may be found in the accessories section.
- Plug-and-play control system is fitted with Carel th-Tune control panel which ensures basic setting options and has user friendly interface. Carel PGDe extended control panel may be fitted on request and provides more flexibility and sophisticated control adjustments. The compact dimensions and elegant design make both suitable for all types of premises.

Default control system functions and optional features are listed below (th-Tune):



- Operation in comfort, precomfort or economy mode
- Temperature control
- Weekly schedule setting: holiday and special day functions, selection of up to four daily time bands with settings for each operating mode
- Coils and heat exchanger auto protection
- Air pressure control, air flow and humidity control (with optional sensors)
- Air quality control (with optional CO₂/IAQ sensors)
- Freecooling or freeheating mode (according to model)
- Pumps control, overload alarms and anti-blocking for each pump (according to model)
- MODBUS supervisor protocol and user friendly WEB-interface via Ethernet port
- PGDe panel's extended settings:
 - Parameters settings divided by level (user, installer or manufacturer) with password-protected access
- 3 adjustable fan speeds
- Priority to temperature or humidity control by room/supply/extract sensors

ROTARY HEAT EXCHANGER (MODELS RH, RV, RP)

Rotary heat exchanger is made of two types of material:

- Sensible type (standard)
- Enthalpy type. Hygroscopic coating is applied on tape, providing additional latent heat transfer from one stream to another. This feature is especially useful when using a rotor in hot and humid areas in conjunction with air conditioning system.

The advantages are: high efficiency, keeping comfortable humidity and low risk of freezing.

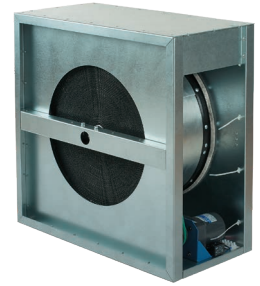

COUNTER-FLOW PLATE HEAT EXCHANGER (MODELS CFH, CFV, CFP)

Heat exchanger is made of profiled aluminum plates, packed with elastic heat-resistant sealant. The sealing provides a reliable separation of the supply and exhaust air, eliminating internal flows, and not allowing moisture, dirt, odors and microorganisms transfer between streams. Bypass channel on heat exchanger with automatic Belimo actuator provides active frost protection, freeheating and freecooling functions.

Drain pan is installed under the heat exchanger on both supply and exhaust sides.



PLUG FANS WITH ELECTRONICALLY COMMUTATED MOTORS (EC MOTORS)

Plug fans with EC motors are used for projects that require high energy efficiency. The advantages of this type of fan are: extremely low power consumption at any speed, no need for external speed control and compact size due to motor with external rotor.



FRAMELESS DESIGN

Frameless casing design excludes thermal bridges, usual for aluminum or steel frame. This significantly increases thermal resistance and reduces heat loss, especially for outdoor installation. It also prevents condensation on the surface when air cooling is on. Casing is made of zinc-aluminum coated sheet steel heat- and sound-insulated with 40 mm mineral wool layer.

Benefits of frameless casing:

- Better thermal resistance
- Lower weight of the unit
- No thermal bridges
- Suitable for outdoor installation in cold climate
- High mechanical strength



HEAT RECOVERY VENTILATION UNIT RH

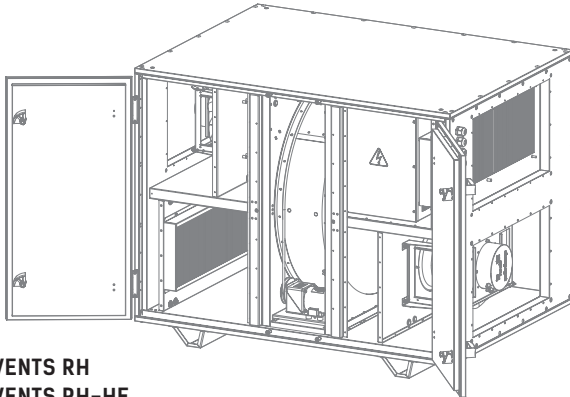

AIRVENTS RH
AIRVENTS RH-HE

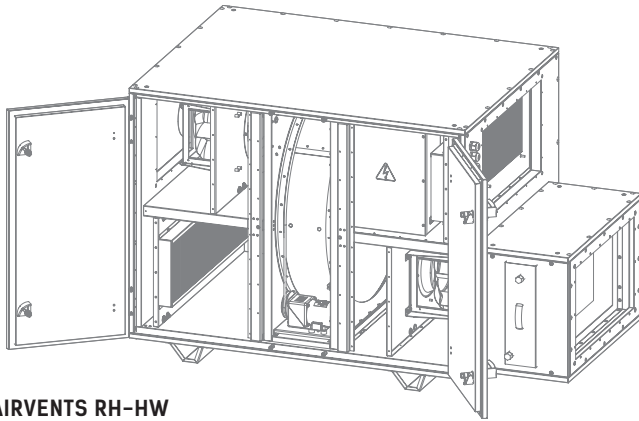

AIRVENTS RH-HW

The brand new premium line of commercial heat recovery air handling units for floor mounting with high-efficient heat exchanger. Available in five standard sizes based on the air flow capacity of 1500, 2500, 3500, 5000 and 6000 m³/h. Optionally accomplished with electric heater (RH-HE series) or water heater (RH-HW series) and ready for operation with all necessary control elements.

Main features:

- High-efficient EC fans, backward-curved, external rotor. Low power consumption at any speed, low noise level and stable operation in any climate conditions.
- Integrated plug-and-play controls on the basis of the Carel kVent.controller. Easy connecting via web-interface using the Ethernet-Modbus and BACnet.
- Insulated double-skin frameless casing.
- High-efficient aluminum rotary heat exchanger.
- The casing panels are made of steel with zinc-aluminium coating and internally lined with 40 mm heat- and sound-insulating mineral wool layer. The units have C4 corrosion resistance class in compliance with ISO 12944. Each model is available in left- and right-handed modifications. The units have service access on both sides and on the bottom.
- Washable F7, G4 (optional) panel filters in exhaust and supply air streams.
- Integrated control panels:
 - A30 th-Tune: standard control panel with handy interface ensures basic setup of parameters.
 - A32 pGDe: control panel with expanded functionality ensures complete setup of parameters.
- Integrated automatic external dampers with Belimo actuators.
- ECO-Design'18 compliant.

Technical parameters

| Model | | RH 1500 | RH 2500 | RH 3500 | RH 5000 | RH 6000 |
|---|--|------------|-------------|------------|------------|-----------|
| Nominal air flow [m ³ /h] | | 1500 | 2500 | 3500 | 5000 | 6000 |
| EC fans | phase/voltage [50–60 Hz/VAC] | ~1.200/277 | | ~3.380/480 | | |
| | power/current [kW/A] | 2x0.46/3.0 | 2x0.74/3.75 | 2x1.14/1.8 | 2x1.32/2.1 | 2x2.6/4.0 |
| | fan speed [min ⁻¹] | 2848 | 2640 | 2400 | 1350 | 1700 |
| | perm. amb. temp. [°C] | -35...+50 | | | | |
| | motor protection | IP54 | | | | |
| | insulation class | F | | | | |
| | motor sound power level to outlet [dBA] | 74 | 75 | 76 | 71 | 77.6 |
| | SFP @ nominal air flow, max. pressure [kW/(m ³ /s)] | 2x1.1 | 2x1.06 | 2x1.13 | 2x0.946 | 2x1.00 |
| Filter class exhaust/supply standard (optional) | F7 (G4)/F7 (G4) | | | | | |
| Weight (net, without packaging) [kg] | 280 | 290 | 335 | 580 | 640 | |
| Protection class | IP34 | | | | | |
| Sound pressure level @ 0.3 m to environment [dBA] | 41 | 43 | 44 | 39 | 46 | |

HEAT RECOVERY VENTILATION UNIT RH, RH-HE, RH-HW

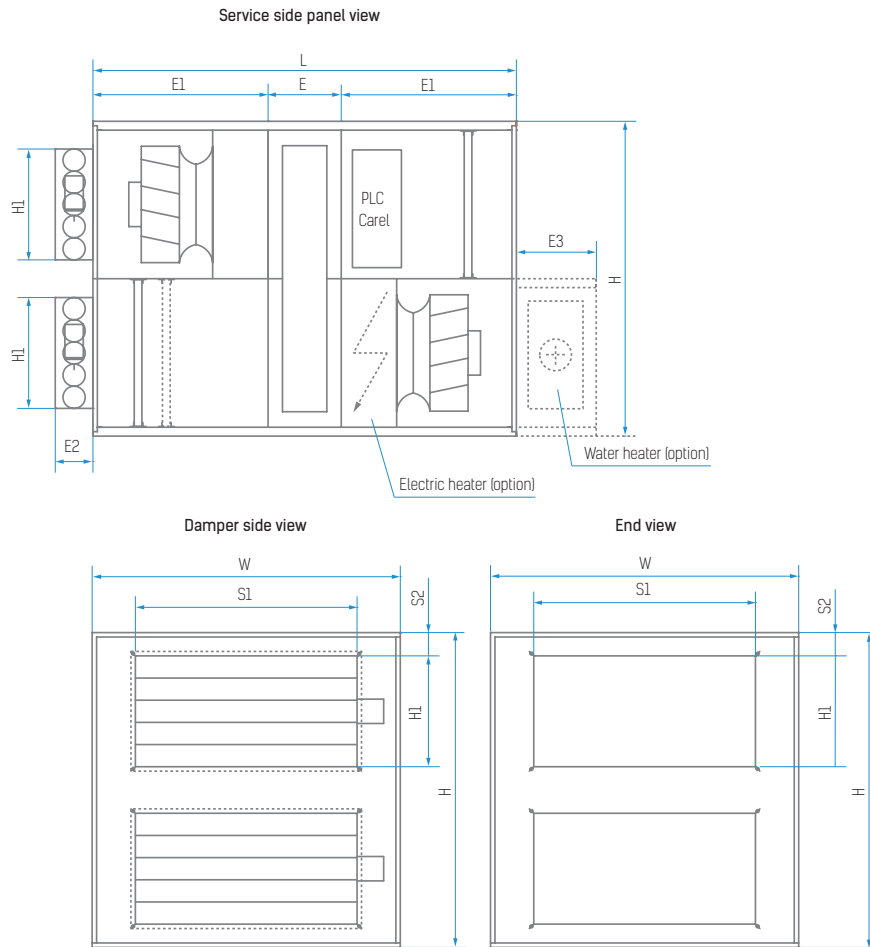

| Dimensions [mm] | RH 1500 | RH 2500 | RH 3500 | RH 5000 | RH 6000 |
|-----------------|---------|---------|---------|---------|---------|
| L | 1300 | 1300 | 1300 | 1910 | 1910 |
| W | 960 | 960 | 1290 | 1390 | 1390 |
| H | 960 | 960 | 1260 | 1420 | 1420 |
| H1 | 350 | 350 | 350 | 500 | 500 |
| S1 | 600 | 600 | 600 | 1000 | 1000 |
| S2 | 55 | 55 | 205 | 105 | 105 |
| E | 290 | 290 | 290 | 330 | 330 |
| E1 | 505 | 505 | 505 | 790 | 790 |
| E2 | 170 | 170 | 170 | 170 | 170 |
| E3 (optional) | 360 | 360 | 360 | 360 | 360 |

RH 1500

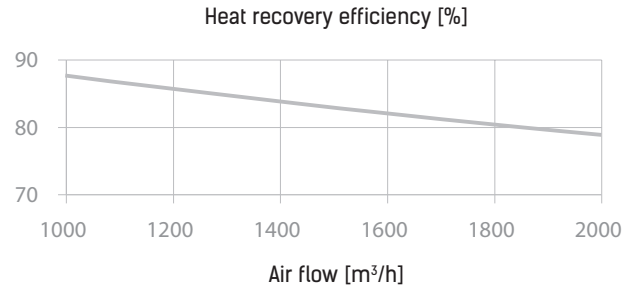
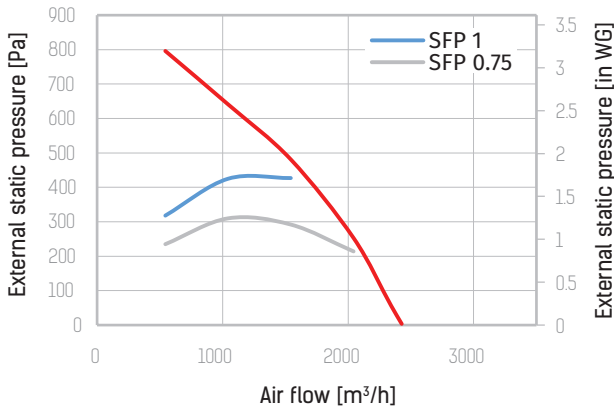

Sound power Lw in dB

| | | | | | | | | | |
|-------------|----|-----|-----|-----|------|------|------|------|-----|
| Environment | 66 | 65 | 62 | 52 | 33 | 53 | 48 | 51 | 59 |
| Outlet | 68 | 69 | 70 | 68 | 65 | 64 | 61 | 58 | 71 |
| Hz | 63 | 125 | 250 | 500 | 1000 | 2000 | 4000 | 8000 | LwA |

RH 2500

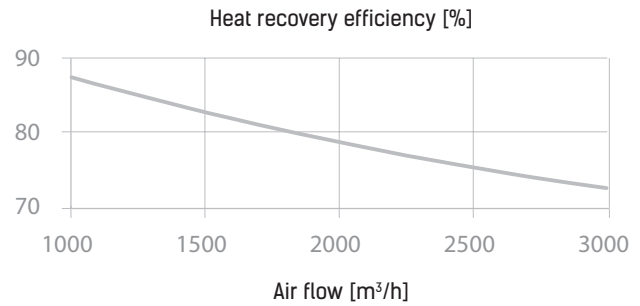
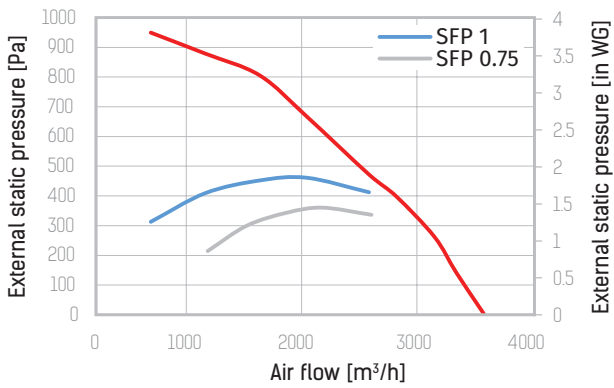

Sound power Lw in dB

| | | | | | | | | | |
|-------------|------|------|------|------|------|------|------|------|------|
| Environment | 63.6 | 65.5 | 64.2 | 58.2 | 40.1 | 57.2 | 52.2 | 55.4 | 63 |
| Outlet | 65.6 | 69.5 | 72.2 | 74.2 | 72.1 | 68.2 | 65.2 | 62.4 | 76.6 |
| Hz | 63 | 125 | 250 | 500 | 1000 | 2000 | 4000 | 8000 | LwA |

RH 3500

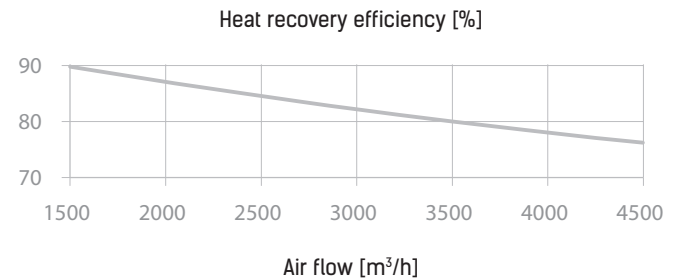
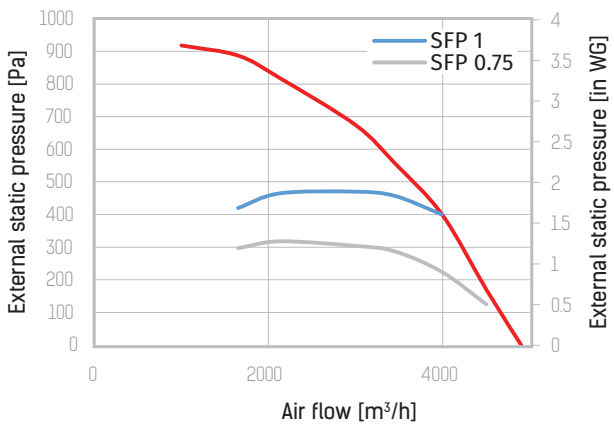

Sound power Lw in dB

| | | | | | | | | | |
|-------------|----|-----|-----|-----|------|------|------|------|-----|
| Environment | 67 | 64 | 66 | 57 | 37 | 59 | 53 | 57 | 64 |
| Outlet | 69 | 68 | 74 | 73 | 65 | 70 | 66 | 64 | 76 |
| Hz | 63 | 125 | 250 | 500 | 1000 | 2000 | 4000 | 8000 | LwA |

*External SFP for each fan [kW/(m³/s)]

RH 5000

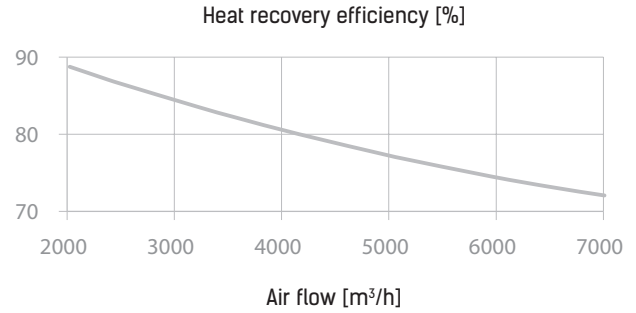
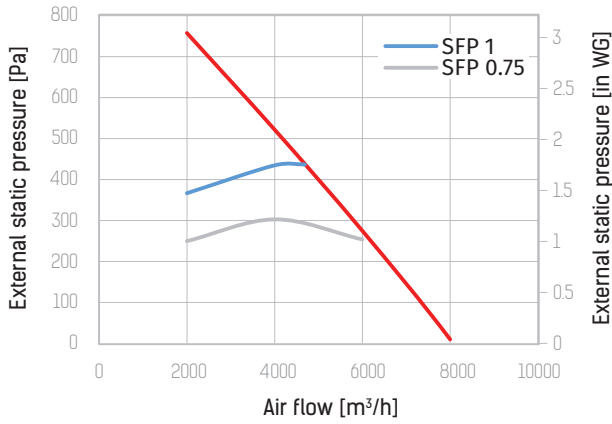

Sound power Lw in dB

| | | | | | | | | | |
|-------------|----|-----|-----|-----|------|------|------|------|-----|
| Environment | 66 | 65 | 62 | 52 | 33 | 53 | 48 | 51 | 59 |
| Outlet | 68 | 69 | 70 | 68 | 65 | 64 | 61 | 58 | 71 |
| Hz | 63 | 125 | 250 | 500 | 1000 | 2000 | 4000 | 8000 | LwA |

RH 6000

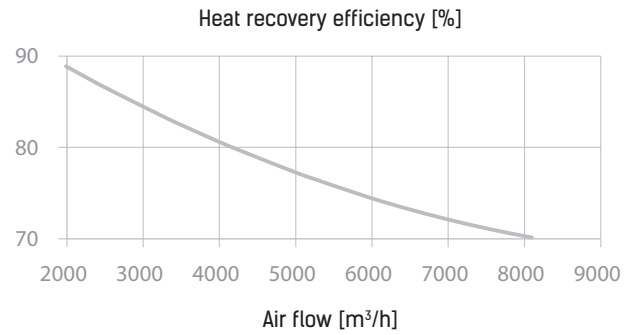
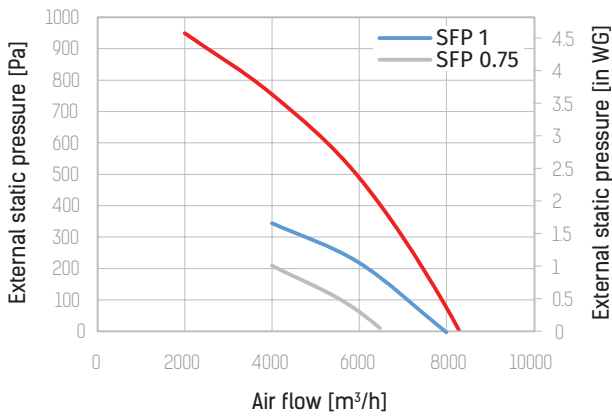

Sound power Lw in dB

| | | | | | | | | | |
|-------------|----|-----|-----|-----|------|------|------|------|-----|
| Environment | 66 | 65 | 62 | 52 | 33 | 53 | 48 | 51 | 59 |
| Outlet | 68 | 69 | 70 | 68 | 65 | 64 | 61 | 58 | 71 |
| Hz | 63 | 125 | 250 | 500 | 1000 | 2000 | 4000 | 8000 | LwA |

*External SFP for each fan [kW/(m³/s)]

HEAT RECOVERY VENTILATION UNIT RV

The brand new premium line of commercial heat recovery air handling units for floor mounting with high-efficient heat exchanger. Available in three standard sizes based on the air flow capacity of 1500, 2500 and 3500 m³/h.

Optionally accomplished with no heater (RV series), electric heater (RV-HE series) or water heater (RV-HW series) and ready for operation with all necessary control elements.

Main features:

- High-efficient EC fans, backward-curved, external rotor. Low power consumption at any speed, low noise level and stable operation in any climate conditions.
- Integrated plug-and-play controls on the basis of the Carel kVent.controller. Easy connecting via web-interface using the Ethernet-Modbus and BACnet.
- Insulated double-skin frameless casing.
- High-efficient aluminum rotary heat exchanger.
- The casing panels are made of steel with zinc-aluminium coating and internally lined with 40 mm heat- and sound-insulating mineral wool layer. The units have C4 corrosion resistance class in compliance with ISO 12944. Each model is available in left- and right-handed modifications. The units have service access on both sides and on the bottom.
- Washable F7, G4 (optional) panel filters in exhaust and supply air streams.
- Integrated control panels:
 - A30 th-Tune: standard control panel with handy interface ensures basic setup of parameters.
 - A32 pGDe: control panel with expanded functionality ensures complete setup of parameters.
- Integrated automatic external dampers with Belimo actuators.
- ECO-Design'18 compliant.

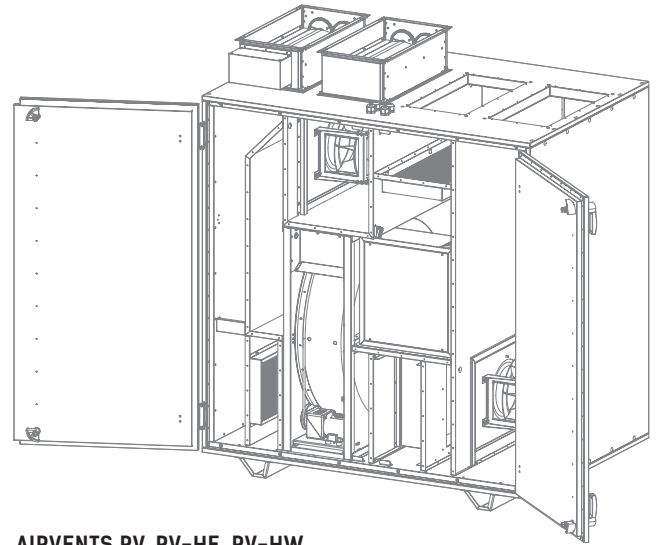

AIRVENTS RV, RV-HE, RV-HW

Technical parameters

| Model | | RV 1500 | RV 2500 | RV 3500 |
|---|--|-----------------|-------------|------------|
| Nominal air flow [m ³ /h] | | 1500 | 2500 | 3500 |
| EC fans | phase/voltage [50–60 Hz/VAC] | ~1.200/277 | | ~3.380/480 |
| | power/current [kW/A] | 2x0.46/3.0 | 2x0.74/3.75 | 2x1.14/1.8 |
| | fan speed [min ⁻¹] | 2848 | 2640 | 2400 |
| | perm. amb. temp. [°C] | -35...+50 | | |
| | motor protection | IP54 | | |
| | insulation class | F | | |
| | motor sound power level to outlet [dBA] | 74 | | |
| | SFP @ nominal air flow, max. pressure [kW/(m ³ /s)] | 2x1.1 | 2x1.06 | 2x1.13 |
| Filter class exhaust/supply standard (optional) | | F7 (G4)/F7 (G4) | | |
| Weight (net, without packaging) [kg] | | 270 | 290 | 330 |
| Protection class | | IP34 | | |
| Sound pressure level @ 0.3 m to environment [dBA] | | 41 | 43 | 44 |

HEAT RECOVERY VENTILATION UNIT RV, RV-HE, RV-HW

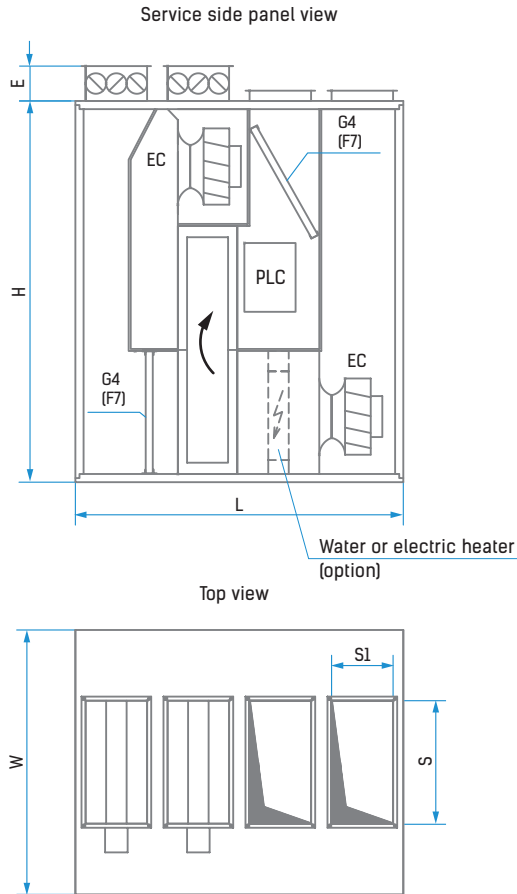

| Dimensions [mm] | RV 1500 | RV 2500 | RV 3500 |
|-----------------|---------|---------|---------|
| L | 1400 | 1400 | 1600 |
| W | 960 | 960 | 1290 |
| H | 1400 | 1400 | 1860 |
| S | 500 | 500 | 600 |
| S1 | 250 | 250 | 350 |
| E | 170 | 170 | 170 |

RV 1500

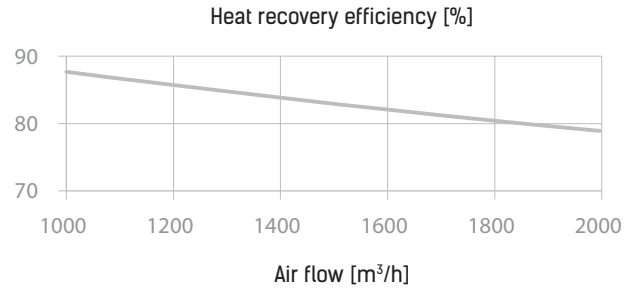
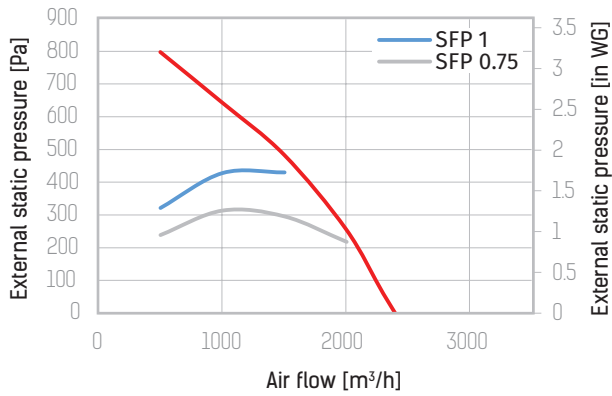

Sound power Lw in dB

| | | | | | | | | | |
|-------------|----|-----|-----|-----|------|------|------|------|-----|
| Environment | 66 | 65 | 62 | 52 | 33 | 53 | 48 | 51 | 59 |
| Outlet | 68 | 69 | 70 | 68 | 65 | 64 | 61 | 58 | 71 |
| Hz | 63 | 125 | 250 | 500 | 1000 | 2000 | 4000 | 8000 | LwA |

RV 2500

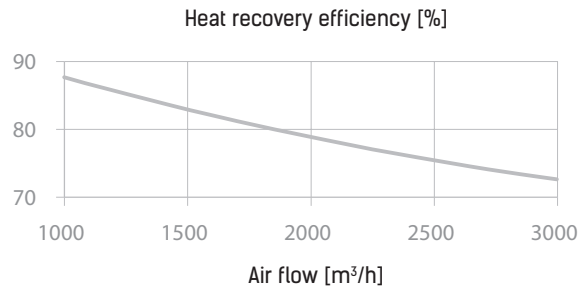
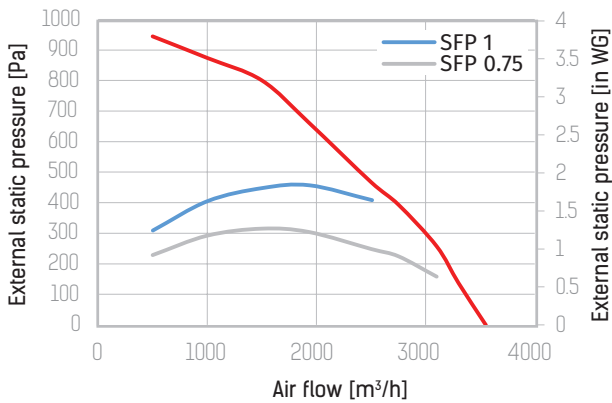

Sound power Lw in dB

| | | | | | | | | | |
|-------------|------|------|------|------|------|------|------|------|------|
| Environment | 63.6 | 65.5 | 64.2 | 58.2 | 40.1 | 57.2 | 52.2 | 55.4 | 59 |
| Outlet | 65.6 | 69.5 | 72.2 | 74.2 | 72.2 | 68.2 | 65.2 | 62.4 | 76.6 |
| Hz | 63 | 125 | 250 | 500 | 1000 | 2000 | 4000 | 8000 | LwA |

RV 3500

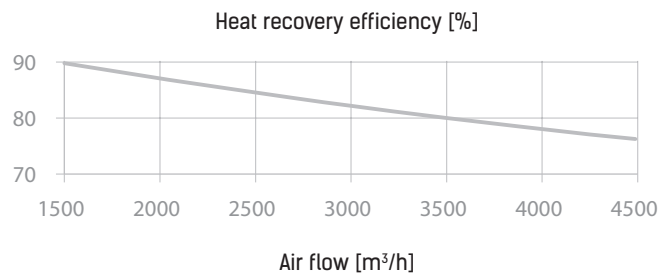
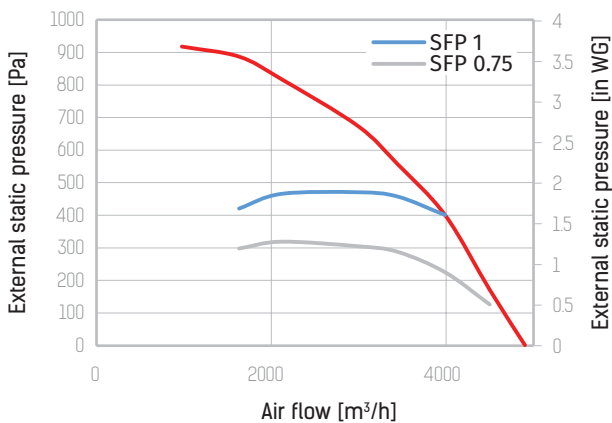

Sound power Lw in dB

| | | | | | | | | | |
|-------------|----|-----|-----|-----|------|------|------|------|-----|
| Environment | 67 | 64 | 66 | 57 | 37 | 59 | 53 | 57 | 64 |
| Outlet | 69 | 68 | 74 | 73 | 69 | 70 | 66 | 64 | 76 |
| Hz | 63 | 125 | 250 | 500 | 1000 | 2000 | 4000 | 8000 | LwA |

*External SFP for each fan [kW/(m³/s)]

HEAT RECOVERY VENTILATION UNIT RP

The brand new premium line of commercial heat recovery air handling units for ceiling mounting with high-efficient heat exchanger. Available in two standard sizes based on the air flow capacity of 1500 and 2500 m³/h.

Optionally accomplished with electric heater (RP-HE series) or water heater (RP-HW series) and ready for operation with all necessary control elements.

Main features:

- High-efficient EC fans, backward-curved, external rotor. Low power consumption at any speed, low noise level and stable operation in any climate conditions.
- Integrated plug-and-play controls on the basis of the Carel kVent.controller. Easy connecting via web-interface using the Ethernet-Modbus and BACnet.
- Insulated double-skin frameless casing.
- High-efficient aluminum rotary heat exchanger.
- The casing panels are made of steel with zinc-aluminium coating and internally lined with 40 mm heat- and sound-insulating mineral wool layer. The units have C4 corrosion resistance class in compliance with ISO 12944. Each model is available in left- and right-handed modifications. The units have service access on both sides and on the bottom.
- Washable F7, G4 (optional) panel filters in exhaust and supply air streams.
- Integrated control panels:
 - A30 th-Tune: standard control panel with handy interface ensures basic setup of parameters.
 - A32 pGDe: control panel with expanded functionality ensures complete setup of parameters.
- Integrated automatic external dampers with Belimo actuators.
- ECO-Design'18 compliant.

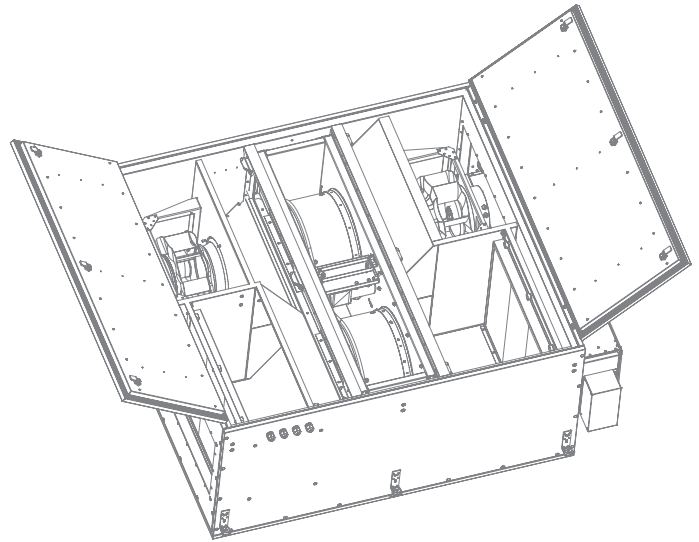

AIRVENTS RP, RP-HE, RP-HW

Technical parameters

| Model | | RP 1500 | RP 2500 |
|---|--|-----------------|-------------|
| Nominal air flow [m ³ /h] | | 1500 | 2500 |
| EC fans | phase/voltage [50–60 Hz/VAC] | ~1.200/277 | |
| | power/current [kW/A] | 2x0.46/3.0 | 2x0.74/3.75 |
| | fan speed [min ⁻¹] | 2848 | 2640 |
| | perm. amb. temp. [°C] | -35...+50 | |
| | motor protection | IP54 | |
| | insulation class | F | |
| | motor sound power level to outlet [dBA] | 74 | 75 |
| | SFP @ nominal air flow, max. pressure [kW/(m ³ /s)] | 2x1.1 | 2x1.06 |
| Filter class exhaust/supply standard (optional) | | F7 (G4)/F7 (G4) | |
| Weight (net, without packaging) [kg] | | 280 | 290 |
| Protection class | | IP34 | |
| Sound pressure level @ 0.3 m to environment [dBA] | | 41 | 43 |

HEAT RECOVERY VENTILATION UNIT RP, RP-HE, RP-HW

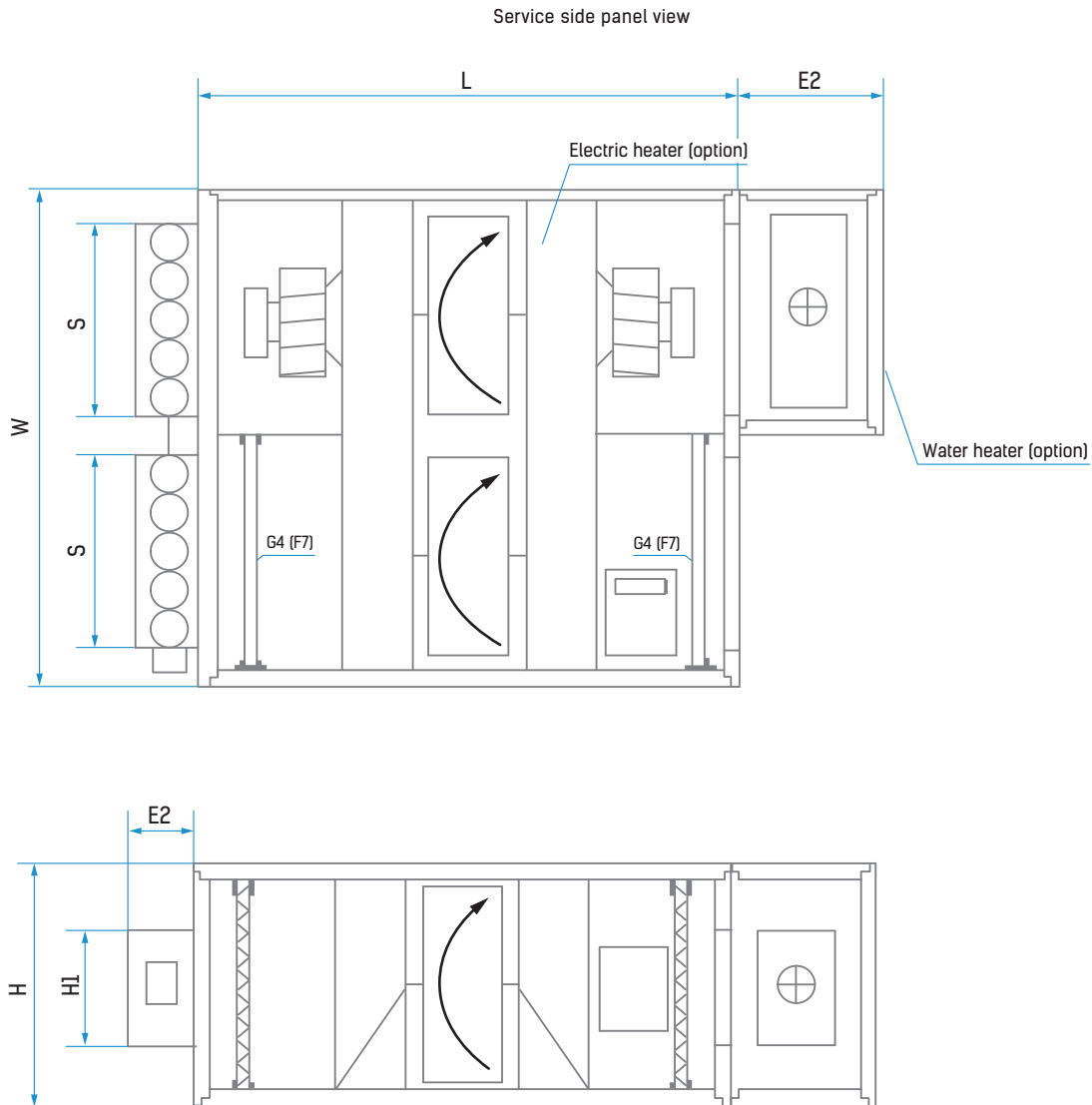

| Dimensions [mm] | RP 1500 | RP 2500 |
|-----------------|---------|---------|
| L | | 1400 |
| W | | 1416 |
| H | | 628 |
| S | | 501 |
| H1 | | 300 |
| E2 | | 171 |
| S1 | | 505 |
| E1 | | 360 |

RP 1500

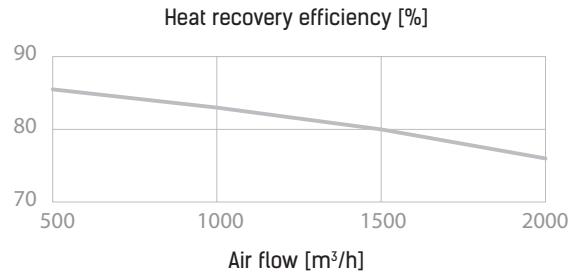
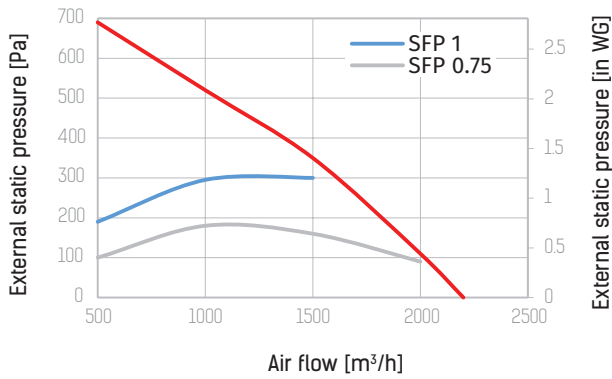

Sound power Lw in dB

| | | | | | | | | | |
|-------------|----|-----|-----|-----|------|------|------|------|-----|
| Environment | 66 | 65 | 62 | 52 | 33 | 53 | 48 | 51 | 59 |
| Outlet | 68 | 69 | 70 | 68 | 65 | 64 | 61 | 58 | 71 |
| Hz | 63 | 125 | 250 | 500 | 1000 | 2000 | 4000 | 8000 | LwA |

RP 2500

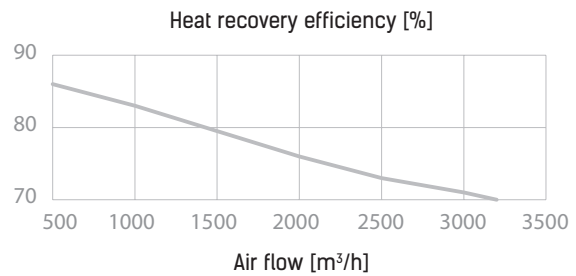
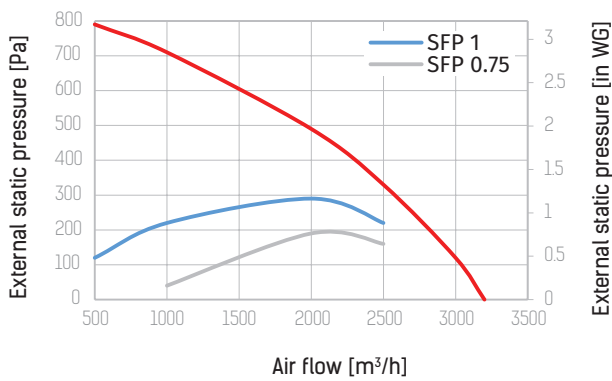

Sound power Lw in dB

| | | | | | | | | | |
|-------------|------|------|------|------|------|------|------|------|------|
| Environment | 63.6 | 65.5 | 64.2 | 58.2 | 40.1 | 57.2 | 52.2 | 55.4 | 63 |
| Outlet | 65.6 | 69.5 | 72.2 | 74.2 | 72.1 | 68.2 | 65.2 | 62.4 | 76.6 |
| Hz | 63 | 125 | 250 | 500 | 1000 | 2000 | 4000 | 8000 | LwA |

*External SFP for each fan [kW/(m³/s)]

HEAT RECOVERY VENTILATION UNIT CFP

The brand new premium line of commercial heat recovery air handling units for suspended mounting with high-efficient counter-flow heat exchanger. Available in three standard sizes based on the air flow capacity of 1500, 2500 and 3500 m³/h. Optionally accomplished with no heater (CFP series), electric heater (CFP-HE series) or water heater (CFP-HW series) and ready for operation with all necessary control elements.

Main features:

- High-efficient EC fans, backward-curved, external rotor. Low power consumption at any speed, low noise level and stable operation in any climate conditions.
- Integrated plug-and-play controls on the basis of the Carel kVent. controller. Easy connecting via web-interface using the Ethernet-Modbus and BACnet.
- Insulated double-skin frameless casing.
- High-efficient counter-flow heat exchanger is made of profiled aluminium plates and impregnated with elastic heat-resistant sealant.
- The stainless steel drain pan is located on the inlet and outlet sides.
- The casing panels are made of steel with zinc-aluminium coating and internally lined with 40 mm heat- and sound-insulating mineral wool layer. The units have C4 corrosion resistance class in compliance with ISO 12944. Each model is available in left- and right-handed modifications. The units have service access on both sides and on the bottom.
- Washable F7, G4 (optional) panel filters in exhaust and supply air streams.
- Integrated control panels:
 - A30 th-Tune: standard control panel with handy interface ensures basic setup of parameters.
 - A32 pGDe: control panel with expanded functionality ensures complete setup of parameters.
- Integrated 100 % bypass of the heat exchanger with automatic damper and Belimo actuator ensures active freeze protection. Free heating and cooling functions are also available. Built-in automatic external air dampers with Belimo actuators.
- ECO-Design'18 compliant.

Technical parameters

| Model | | CFP 1500 | CFP 2500 | CFP 3500 |
|---|--|-----------------|-------------|------------|
| Nominal air flow [m ³ /h] | | 1500 | 2500 | 3500 |
| EC fans | phase/voltage [50–60 Hz/VAC] | ~1.200/277 | | ~3.380/480 |
| | power/current [kW/A] | 2x0.46/3.0 | 2x0.74/3.75 | 2x1.14/1.8 |
| | fan speed [min ⁻¹] | 2848 | 2640 | 2400 |
| | perm. amb. temp. [°C] | -35...+50 | | |
| | motor protection | IP54 | | |
| | insulation class | F | | |
| | motor sound power level to outlet [dBA] | 74 | | |
| | SFP @ nominal air flow, max. pressure [kW/(m ³ /s)] | 2x1.1 | 2x1.06 | 2x1.13 |
| Filter class exhaust/supply standard (optional) | | F7 (G4)/F7 (G4) | | |
| Weight (net, without packaging) [kg] | | 270 | 290 | 320 |
| Protection class | | IP34 | | |
| Sound pressure level @ 0.3 m to environment [dBA] | | 41 | 43 | 44 |

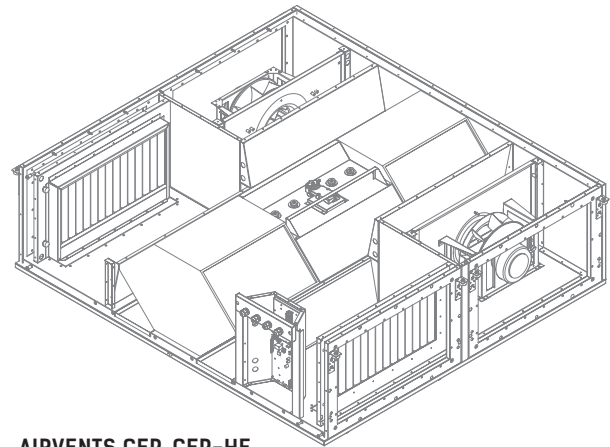

AIRVENTS CFP, CFP-HE

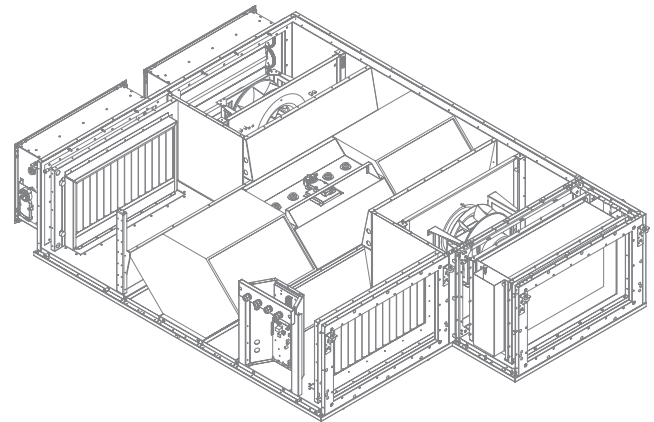

AIRVENTS CFP-HW

HEAT RECOVERY VENTILATION UNIT CFP, CFP-HE, CFP-HW

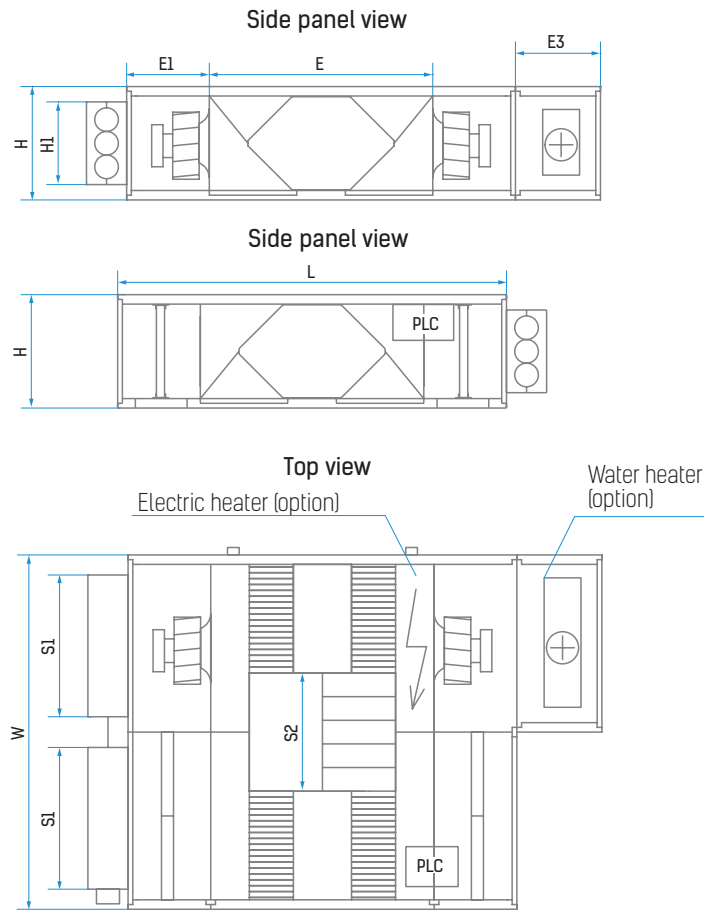

| Dimensions [mm] | CFP 1500 | CFP 2500 | CFP 3500 |
|-----------------|----------|----------|----------|
| L | 1646 | 1646 | 1880 |
| W | 1500 | 1500 | 1500 |
| H | 480 | 480 | 630 |
| H1 | 350 | 350 | 350 |
| S1 | 600 | 600 | 600 |
| S2 | 500 | 500 | 220 |
| E | 946 | 946 | 1440 |
| E1 | 350 | 350 | 360 |
| E3 (option) | 360 | 360 | 360 |

CFP 1500

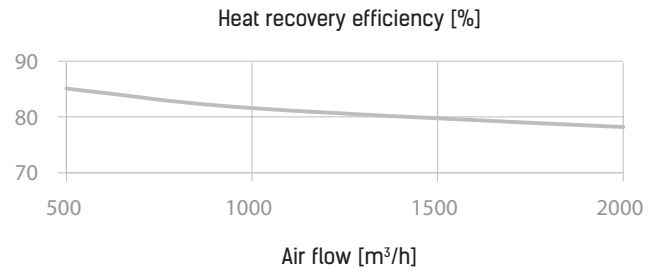
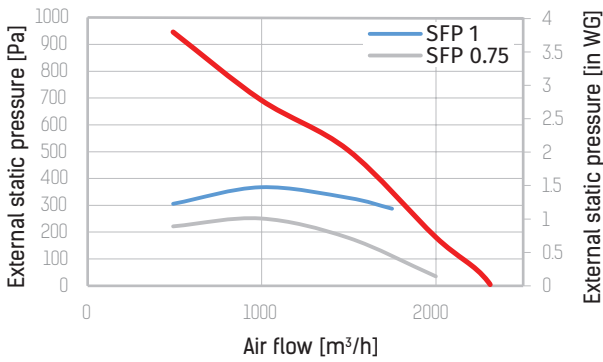

Sound power Lw in dB

| | | | | | | | | | |
|-------------|----|-----|-----|-----|------|------|------|------|-----|
| Environment | 66 | 65 | 62 | 52 | 33 | 53 | 48 | 51 | 59 |
| Outlet | 68 | 69 | 70 | 68 | 65 | 64 | 61 | 58 | 71 |
| Hz | 63 | 125 | 250 | 500 | 1000 | 2000 | 4000 | 8000 | LwA |

CFP 2500

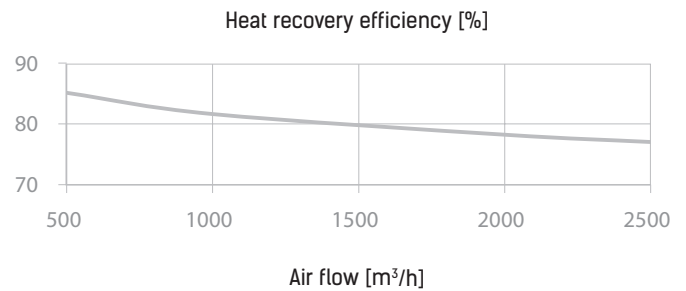
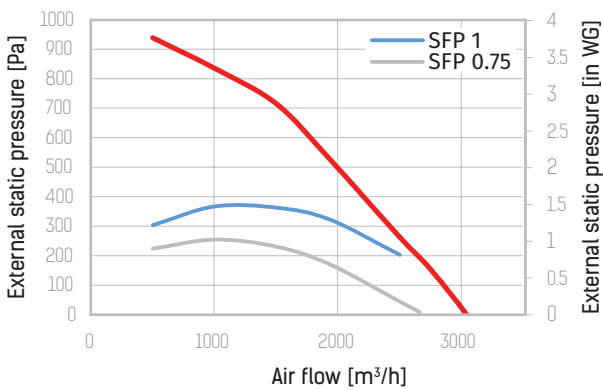

Sound power Lw in dB

| | | | | | | | | | |
|-------------|------|------|------|------|------|------|------|------|------|
| Environment | 63.6 | 65.5 | 64.2 | 58.2 | 40.1 | 57.2 | 52.2 | 55.4 | 63 |
| Outlet | 65.6 | 69.5 | 72.2 | 74.2 | 72.1 | 68.2 | 65.2 | 62.4 | 76.6 |
| Hz | 63 | 125 | 250 | 500 | 1000 | 2000 | 4000 | 8000 | LwA |

CFP 3500

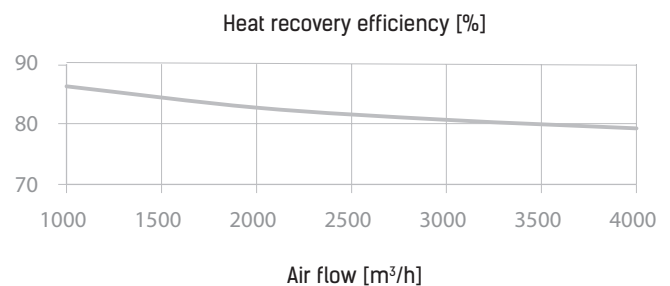
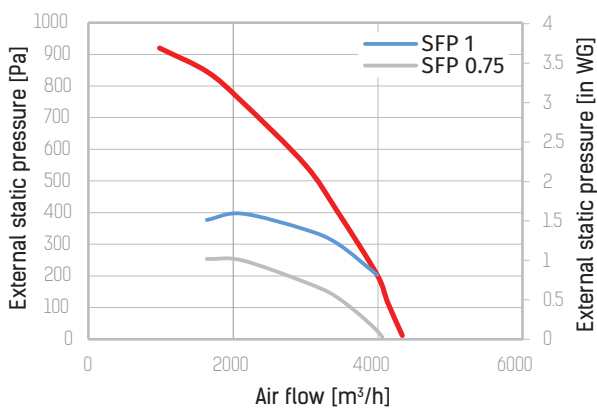

Sound power Lw in dB

| | | | | | | | | | |
|-------------|------|------|------|------|------|------|------|------|------|
| Environment | 63.6 | 65.5 | 64.2 | 58.2 | 40.1 | 57.2 | 52.2 | 55.4 | 63 |
| Outlet | 65.6 | 69.5 | 72.2 | 74.2 | 72.1 | 68.2 | 65.2 | 62.4 | 76.6 |
| Hz | 63 | 125 | 250 | 500 | 1000 | 2000 | 4000 | 8000 | LwA |

*External SFP for each fan [kW/(m³/s)]

HEAT RECOVERY VENTILATION UNIT CFH

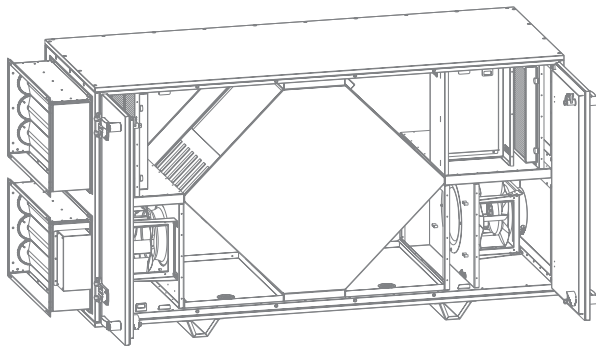

AIRVENTS CFH, CFH-HE

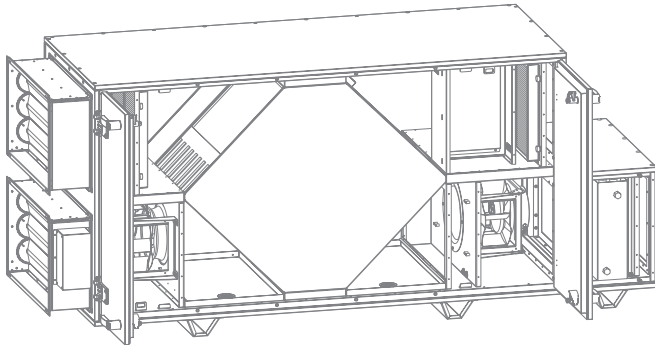

AIRVENTS CFH-HW

The brand new premium line of commercial heat recovery air handling units for floor mounting with high-efficient counter-flow heat exchanger. Available in five standard sizes based on the air flow capacity of 1500, 2500, 3500, 5000 and 6000 m³/h. Optionally accomplished with no heater (CFH series), electric heater (CFH-HE series) or water heater (CFH-HW series) and ready for operation with all necessary control elements.

Main features:

- High-efficient EC fans, backward-curved, external rotor. Low power consumption at any speed, low noise level and stable operation in any climate conditions.
- Integrated plug-and-play controls on the basis of the Carel kVent. controller. Easy connecting via web-interface using the Ethernet-Modbus and BACnet.
- Insulated double-skin frameless casing.
- High-efficient counter-flow heat exchanger is made of profiled aluminium plates and impregnated with elastic heat-resistant sealant.
- The stainless steel drain pan is located on the inlet and outlet sides..
- The casing panels are made of steel with zinc-aluminium coating and internally lined with 40 mm heat- and sound-insulating mineral wool layer. The units have C4 corrosion resistance class in compliance with ISO 12944. Each model is available in left- and right-handed modifications. The units have service access on both sides and on the bottom.
- Washable F7, G4 (optional) panel filters in exhaust and supply air streams.
- Integrated control panels:
 - A30 th-Tune: standard control panel with handy interface ensures basic setup of parameters.
 - A32 pGDe: control panel with expanded functionality ensures complete setup of parameters.
- Integrated 100 % bypass of the heat exchanger with automatic damper and Belimo actuator ensures active freeze protection. Free heating and cooling functions are also available. Built-in automatic external air dampers with Belimo actuators.
- ECO-Design'18 compliant.

Technical parameters

| Model | | CFH 1500 | CFH 2500 | CFH 3500 | CFH 5000 | CFH 6000 |
|---|--|------------|-------------|------------|------------|-----------|
| Nominal air flow [m ³ /h] | | 1500 | 2500 | 3500 | 5000 | 6000 |
| EC fans | phase/voltage [50–60 Hz/VAC] | ~1.200/277 | | | ~3.380/480 | |
| | power/current [kW/A] | 2x0.46/3.0 | 2x0.74/3.75 | 2x1.14/1.8 | 2x1.32/2.1 | 2x2.6/4.0 |
| | fan speed [min ⁻¹] | 2848 | 2640 | 2400 | 1350 | 1700 |
| | perm. amb. temp. [°C] | -35...+50 | | | | |
| | motor protection | IP54 | | | | |
| | insulation class | F | | | | |
| | motor sound power level to outlet [dBA] | 74 | 75 | 76 | 71 | 77.6 |
| | SFP @ nominal air flow, max. pressure [kW/(m ³ /s)] | 2x1.1 | 2x1.06 | 2x1.13 | 2x0.946 | 2x1.00 |
| Filter class exhaust/supply standard (optional) | F7 (G4)/F7 (G4) | | | | | |
| Weight (net, without packaging) [kg] | 270 | 310 | 360 | 570 | 620 | |
| Protection class | IP34 | | | | | |
| Sound pressure level @ 0.3 m to environment [dBA] | 41 | 43 | 44 | 39 | 46 | |

HEAT RECOVERY VENTILATION UNIT CFH, CFH-HE, CFH-HW

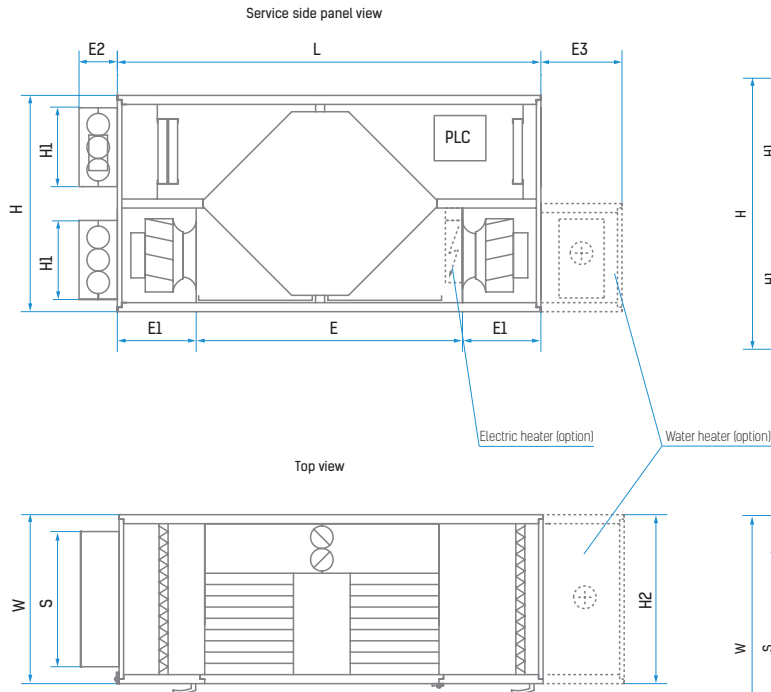
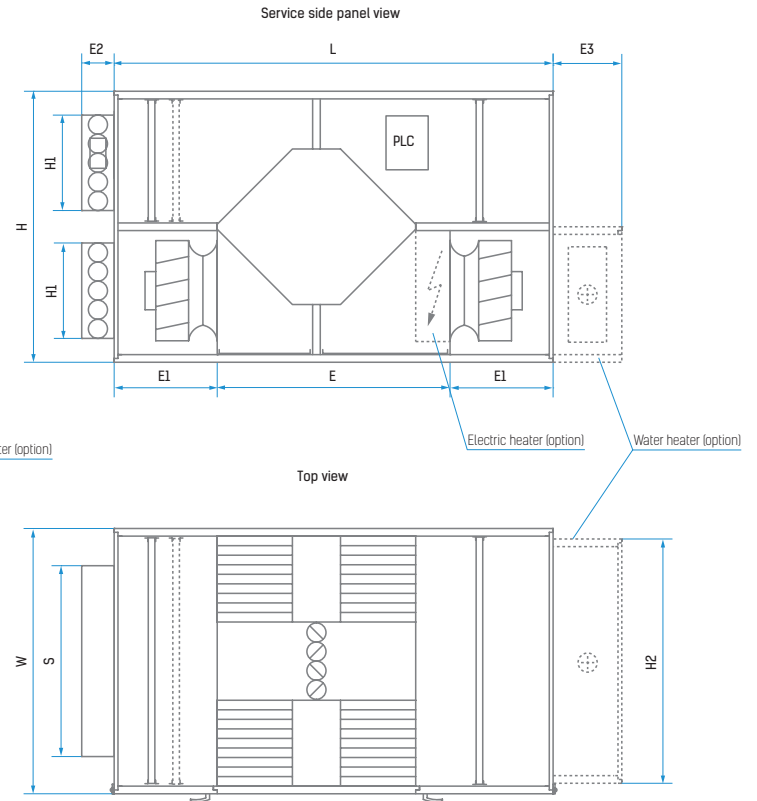
CFH 1500, CFH 2000

CFH 3500, CFH 5000, CFH 6000

| Dimensions [mm] | CFH 1500 | CFH 2500 | CFH 3500 | CFH 5000 | CFH 6000 |
|-----------------|----------|----------|----------|----------|----------|
| L | 1880 | 1880 | 2200 | 2300 | 2300 |
| W | 750 | 750 | 890 | 1390 | 1390 |
| H | 960 | 960 | 1290 | 1420 | 1420 |
| H1 | 350 | 350 | 350 | 500 | 500 |
| H2 (optional) | 750 | 750 | 890 | 1280 | 1280 |
| S | 600 | 600 | 600 | 1000 | 1000 |
| E | 1180 | 1180 | 1500 | 1220 | 1220 |
| E1 | 350 | 350 | 350 | 540 | 540 |
| E2 | 170 | 170 | 170 | 170 | 170 |
| E3 (optional) | 360 | 360 | 360 | 360 | 360 |

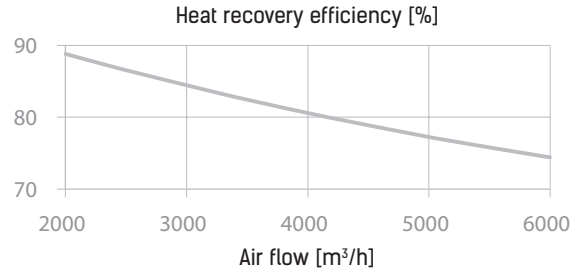
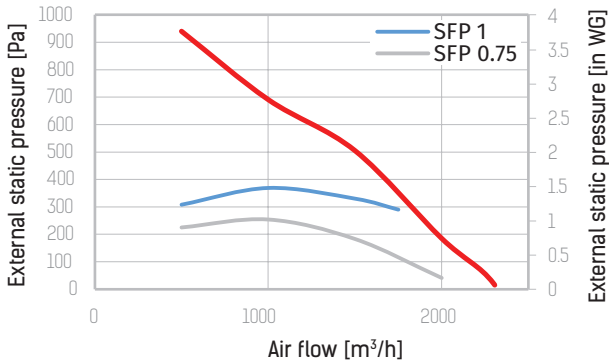
CFH 1500



Sound power Lw in dB

| | | | | | | | | | |
|-------------|----|-----|-----|-----|------|------|------|------|-----|
| Environment | 66 | 65 | 62 | 52 | 33 | 53 | 48 | 51 | 59 |
| Outlet | 68 | 69 | 70 | 68 | 65 | 64 | 61 | 58 | 71 |
| Hz | 63 | 125 | 250 | 500 | 1000 | 2000 | 4000 | 8000 | LwA |

CFH 2500

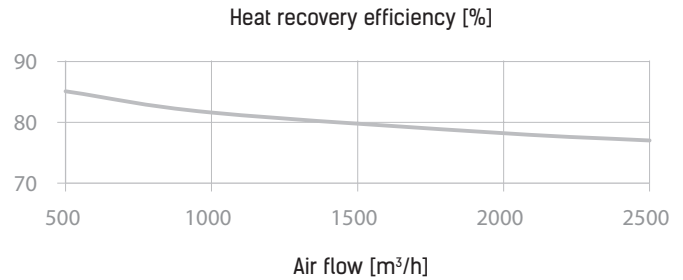
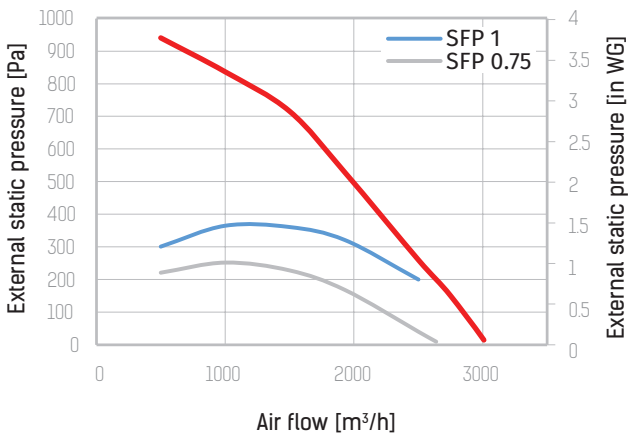

Sound power Lw in dB

| | | | | | | | | | |
|-------------|------|------|------|------|------|------|------|------|------|
| Environment | 63.6 | 65.5 | 64.2 | 58.2 | 40.1 | 57.2 | 52.2 | 55.4 | 63 |
| Outlet | 65.6 | 69.5 | 72.2 | 74.2 | 72.1 | 68.2 | 65.2 | 62.4 | 76.6 |
| Hz | 63 | 125 | 250 | 500 | 1000 | 2000 | 4000 | 8000 | LwA |

CFH 3500

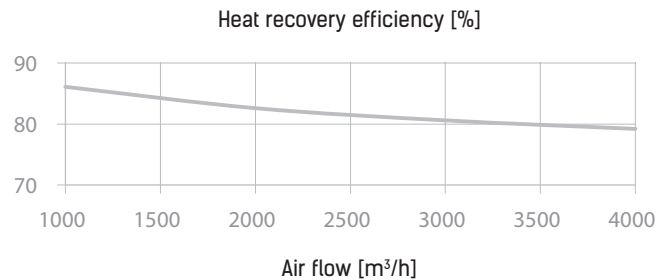
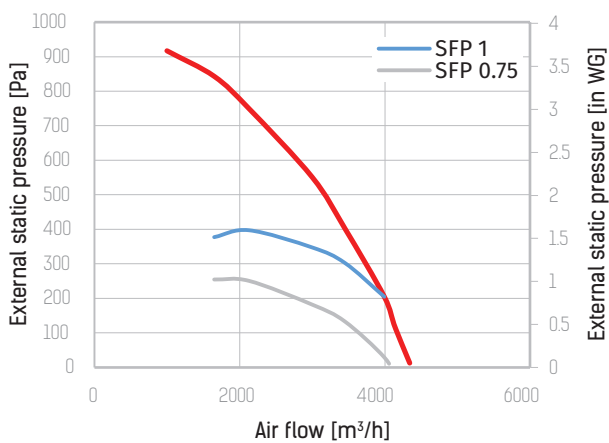

Sound power Lw in dB

| | | | | | | | | | |
|-------------|----|-----|-----|-----|------|------|------|------|-----|
| Environment | 67 | 64 | 66 | 57 | 37 | 59 | 53 | 57 | 64 |
| Outlet | 69 | 68 | 74 | 73 | 69 | 70 | 66 | 64 | 76 |
| Hz | 63 | 125 | 250 | 500 | 1000 | 2000 | 4000 | 8000 | LwA |

*External SFP for each fan [kW/(m³/s)]

CFH 5000

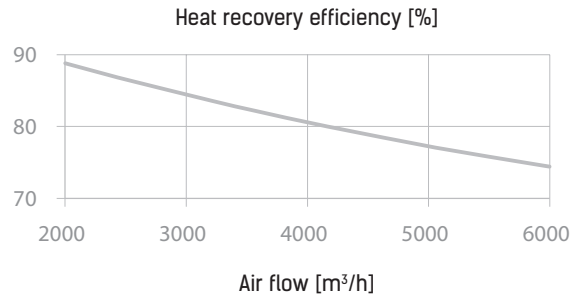
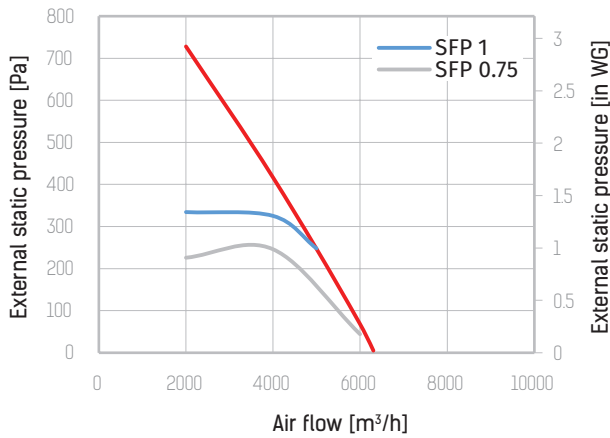

Sound power Lw in dB

| | | | | | | | | | |
|-------------|----|-----|-----|-----|------|------|------|------|-----|
| Environment | 66 | 65 | 62 | 52 | 33 | 53 | 48 | 51 | 59 |
| Outlet | 68 | 69 | 70 | 68 | 65 | 64 | 61 | 58 | 71 |
| Hz | 63 | 125 | 250 | 500 | 1000 | 2000 | 4000 | 8000 | LwA |

CFH 6000

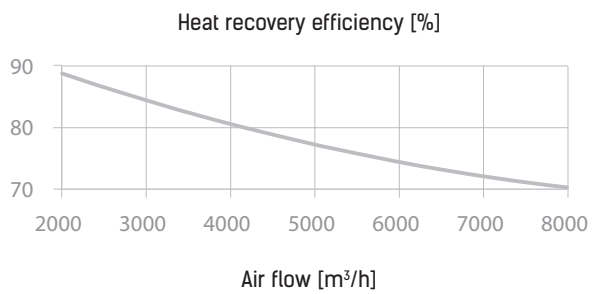
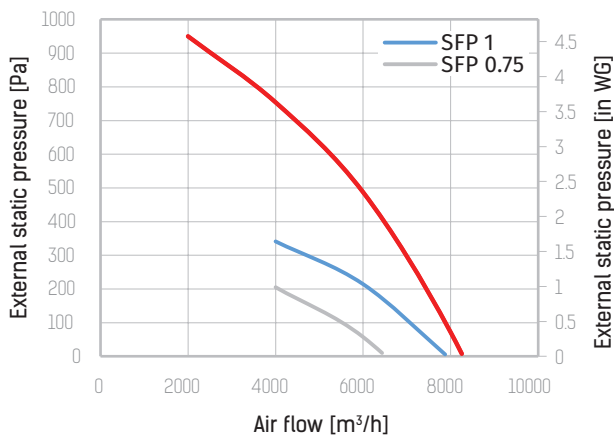

Sound power Lw in dB

| | | | | | | | | | |
|-------------|----|-----|-----|-----|------|------|------|------|-----|
| Environment | 66 | 65 | 62 | 52 | 33 | 53 | 48 | 51 | 59 |
| Outlet | 68 | 69 | 70 | 68 | 65 | 64 | 61 | 58 | 71 |
| Hz | 63 | 125 | 250 | 500 | 1000 | 2000 | 4000 | 8000 | LwA |

*External SFP for each fan [kW/(m³/s)]

HEAT RECOVERY VENTILATION UNIT CFV

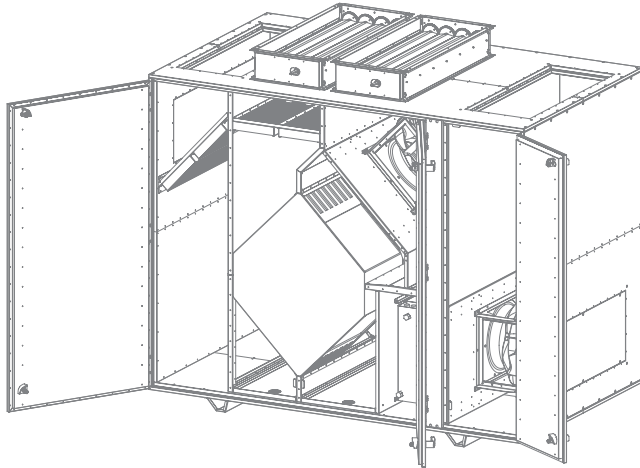

AIRVENTS CFV, CFV-HE, CFV-HW

The brand new premium line of commercial heat recovery air handling units for floor mounting with high-efficient counter-flow heat exchanger. Available in five standard sizes based on the air flow capacity of 1500, 2500, 3500, 5000 and 6000 m³/h. Optionally accomplished with no heater (CFH series), electric heater (CFH-HE series) or water heater (CFH-HW series) and ready for operation with all necessary control elements.

Main features:

- High-efficient EC fans, backward-curved, external rotor. Low power consumption at any speed, low noise level and stable operation in any climate conditions.
- Integrated plug-and-play controls on the basis of the Carel kVent. controller. Easy connecting via web-interface using the Ethernet-Modbus and BACnet.
- Insulated double-skin frameless casing.
- High-efficient counter-flow heat exchanger is made of profiled aluminium plates and impregnated with elastic heat-resistant sealant.
- The stainless steel drain pan is located on the inlet and outlet sides.
- The casing panels are made of steel with zinc-aluminium coating and internally lined with 40 mm heat- and sound-insulating mineral wool layer. The units have C4 corrosion resistance class in compliance with ISO 12944. Each model is available in left- and right-handed modifications. The units have service access on both sides and on the bottom.
- Washable F7, G4 (optional) panel filters in exhaust and supply air streams.
- Integrated control panels:
 - A30 th-Tune: standard control panel with handy interface ensures basic setup of parameters.
 - A32 pGDe: control panel with expanded functionality ensures complete setup of parameters.
- Integrated 100 % bypass of the heat exchanger with automatic damper and Belimo actuator ensures active freeze protection. Free heating and cooling functions are also available. Built-in automatic external air dampers with Belimo actuators.
- ECO-Design'18 compliant.

Technical parameters

| Model | | CFV 1500 | CFV 2500 | CFV 3500 | CFV 5000 | CFV 6000 |
|---|--|------------|-------------|------------|------------|-----------|
| Nominal air flow [m ³ /h] | | 1500 | 2500 | 3500 | 5000 | 6000 |
| EC fans | phase/voltage [50–60 Hz/VAC] | ~1.200/277 | | | ~3.380/480 | |
| | power/current [kW/A] | 2x0.46/3.0 | 2x0.74/3.75 | 2x1.14/1.8 | 2x1.32/2.1 | 2x2.6/4.0 |
| | fan speed [min ⁻¹] | 2848 | 2640 | 2400 | 1350 | 1700 |
| | perm. amb. temp. [°C] | -35...+50 | | | | |
| | motor protection | IP54 | | | | |
| | insulation class | F | | | | |
| | motor sound power level to outlet [dBA] | 74 | 75 | 76 | 71 | 77.6 |
| | SFP @ nominal air flow, max. pressure [kW/(m ³ /s)] | 2x1.1 | 2x1.06 | 2x1.13 | 2x0.946 | 2x1.00 |
| Filter class exhaust/supply standard (optional) | F7 (G4)/F7 (G4) | | | | | |
| Weight (net, without packaging) [kg] | 230 | 250 | 280 | 400 | 530 | |
| Protection class | IP34 | | | | | |
| Sound pressure level @ 0.3 m to environment [dBA] | 41 | 43 | 44 | 39 | 46 | |

HEAT RECOVERY VENTILATION UNIT CFV, CFV-HE, CFV-HW

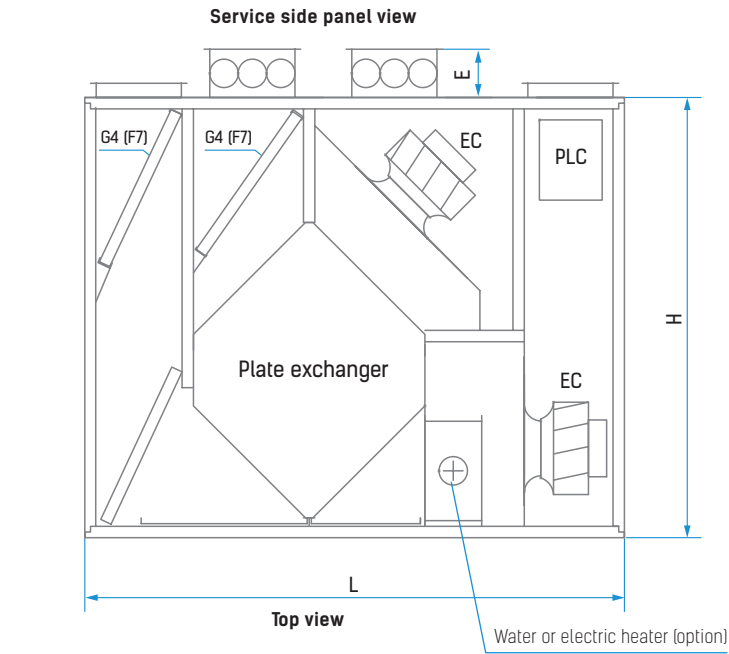
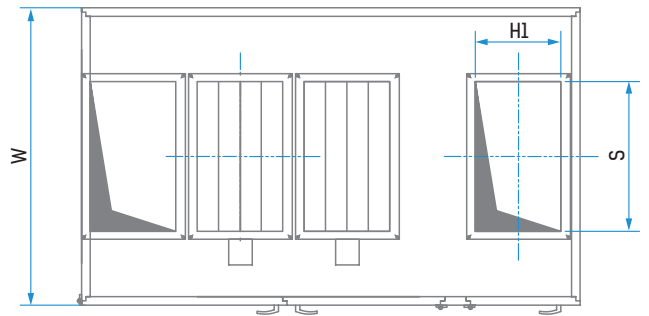
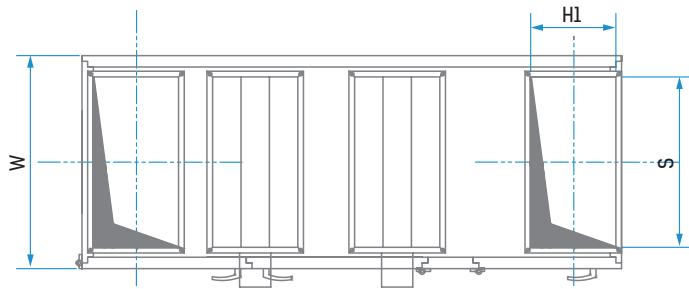
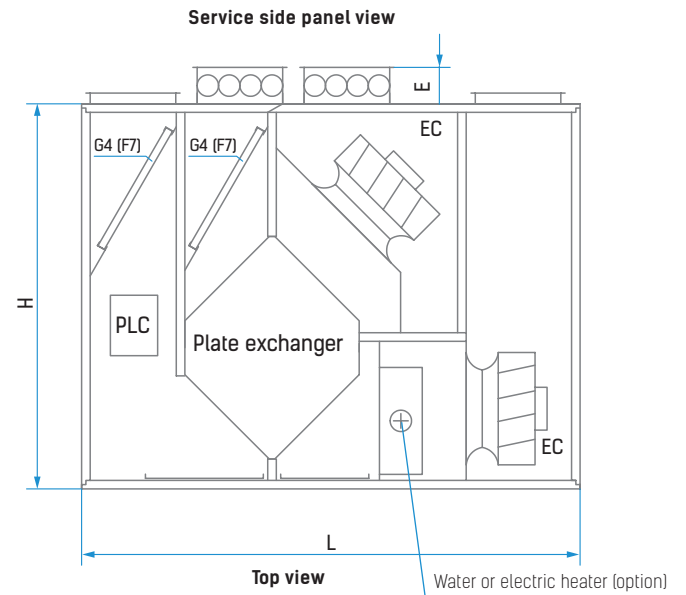
CFV 1500, CFV 2000

CFV 3500, CFV 5000, CFV 6000

| Dimensions [mm] | CFV 1500 | CFV 2500 | CFV 3500 | CFV 5000 | CFV 6000 |
|-----------------|----------|----------|----------|----------|----------|
| L | 1950 | 1950 | 2200 | 2330 | 2330 |
| W | 750 | 750 | 890 | 1390 | 1390 |
| H | 1550 | 1550 | 1800 | 1800 | 1800 |
| H1 | 300 | 300 | 300 | 400 | 400 |
| S | 600 | 600 | 600 | 1000 | 1000 |
| E | 170 | 170 | 170 | 170 | 170 |

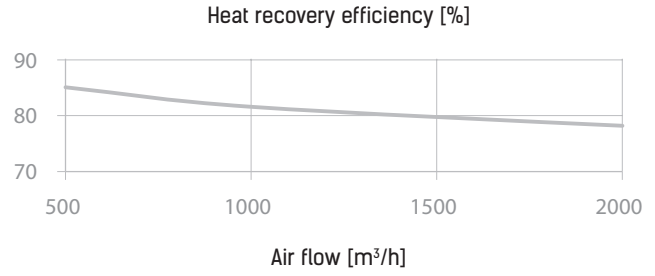
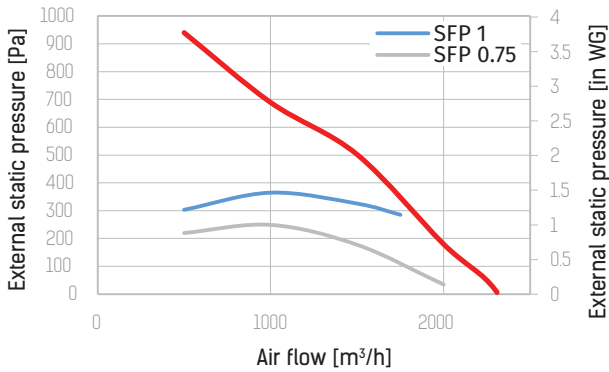
CFV 1500



Sound power Lw in dB

| | | | | | | | | | |
|-------------|----|-----|-----|-----|------|------|------|------|-----|
| Environment | 66 | 65 | 62 | 52 | 33 | 53 | 48 | 51 | 59 |
| Outlet | 68 | 69 | 70 | 68 | 65 | 64 | 61 | 58 | 71 |
| Hz | 63 | 125 | 250 | 500 | 1000 | 2000 | 4000 | 8000 | LwA |

CFV 2500

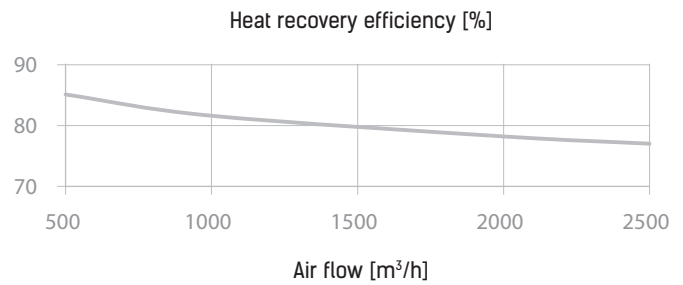
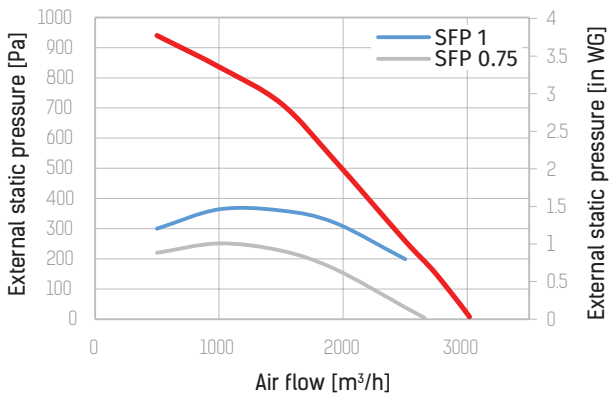

Sound power Lw in dB

| | | | | | | | | | |
|-------------|------|------|------|------|------|------|------|------|------|
| Environment | 63.6 | 65.5 | 64.2 | 58.2 | 40.1 | 57.2 | 52.2 | 55.4 | 63 |
| Outlet | 65.6 | 69.5 | 72.2 | 74.2 | 72.1 | 68.2 | 65.2 | 62.4 | 76.6 |
| Hz | 63 | 125 | 250 | 500 | 1000 | 2000 | 4000 | 8000 | LwA |

CFV 3500

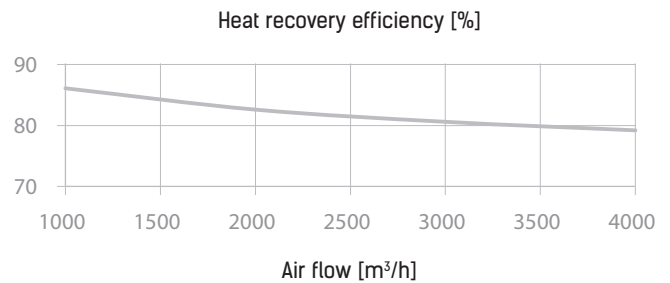
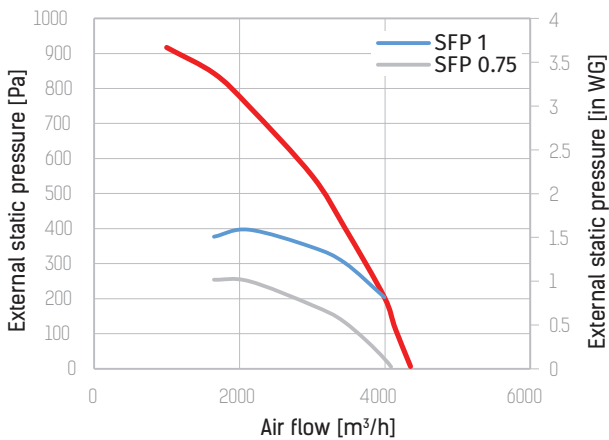

Sound power Lw in dB

| | | | | | | | | | |
|-------------|----|-----|-----|-----|------|------|------|------|-----|
| Environment | 67 | 64 | 66 | 57 | 37 | 59 | 53 | 57 | 64 |
| Outlet | 69 | 68 | 74 | 73 | 69 | 70 | 66 | 64 | 76 |
| Hz | 63 | 125 | 250 | 500 | 1000 | 2000 | 4000 | 8000 | LwA |

*External SFP for each fan [kW/(m³/s)]

CFV 5000

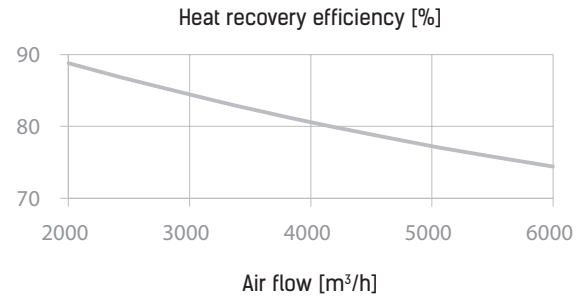
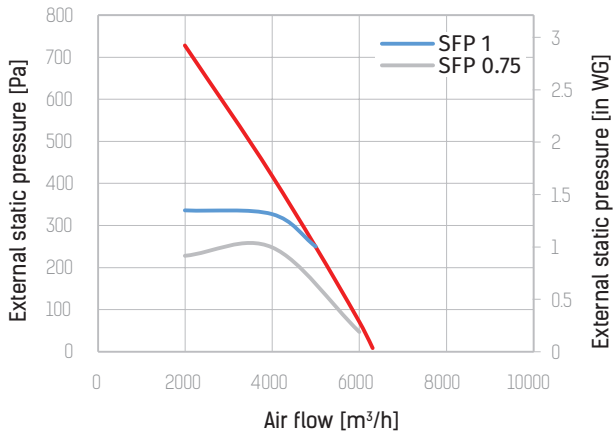

Sound power Lw in dB

| | | | | | | | | | |
|-------------|----|-----|-----|-----|------|------|------|------|-----|
| Environment | 66 | 65 | 62 | 52 | 33 | 53 | 48 | 51 | 59 |
| Outlet | 68 | 69 | 70 | 68 | 65 | 64 | 61 | 58 | 71 |
| Hz | 63 | 125 | 250 | 500 | 1000 | 2000 | 4000 | 8000 | LwA |

CFV 6000

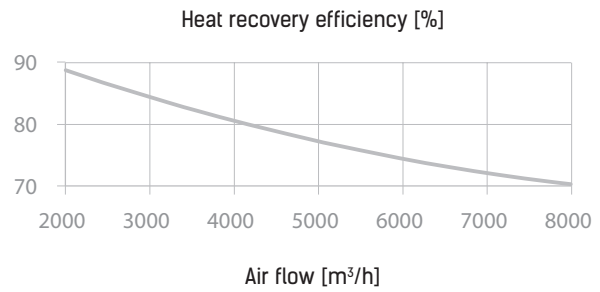
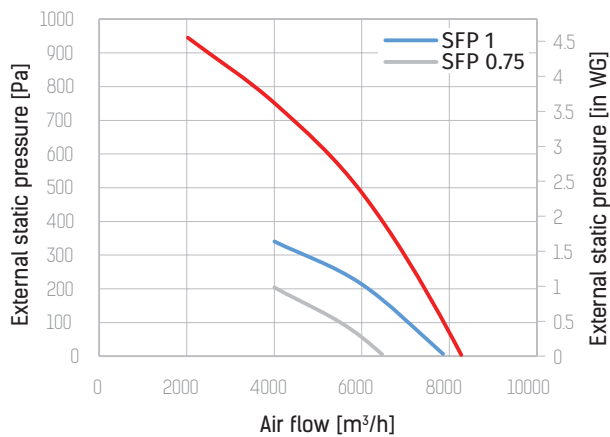

Sound power Lw in dB

| | | | | | | | | | |
|-------------|----|-----|-----|-----|------|------|------|------|-----|
| Environment | 66 | 65 | 62 | 52 | 33 | 53 | 48 | 51 | 59 |
| Outlet | 68 | 69 | 70 | 68 | 65 | 64 | 61 | 58 | 71 |
| Hz | 63 | 125 | 250 | 500 | 1000 | 2000 | 4000 | 8000 | LwA |

*External SFP for each fan [kW/(m³/s)]



VENTS reserves the rights to modify any of its products' features, designs, components and specifications at any time and without notice to maintain the development and quality of manufactured goods.

