

Series
VENTS KSA



Centrifugal fans in heat-and sound-insulated casing with the air flow up to **750 m³/h**

Applications

KSA fan design enables their application in supply and exhaust ventilation systems for commercial, office and other public or industrial premises with high noise level requirements. Suitable for connection with Ø 100, 125, 150, 160 and 200 mm round ducts.

Design

The fan casing is made of aluzinc. Heat- and sound-insulating layer is made of polystyrene foam.

Motor

The impeller with forward curved blades made of galvanized steel is powered by 2- or 4-pole external rotor asyn-

chronous motor. The motor is equipped with the ball bearings for long service life. For precise features, safe operation and low noise, each impeller is dynamically balanced while assembly. Motor protection rating IP44.

Speed control

Smooth or step speed control with a thyristor or autotransformer speed controller. Several fans may be connected to one speed controller provided that the total power and operating current do not exceed the rated speed controller parameters.

Mounting

Connection pipes have round section. The fan basic delivery set includes a power cord without an electrical plug. Electric connection and mounting shall be performed in compliance with the operation manual and wiring diagram.

The fan with electronic temperature and control module (U option).

The ideal solution for ventilation of the premises requiring permanent temperature control, i.e. greenhouses. The fan with the electronic temperature and speed control module provides automatic control of the motor speed (air flow) depending on air temperature in the air duct or in the room.

The front panel of the electronic module has the following control knobs:

- speed control knob for setting the motor speed;
- thermostat control knob for setting the temperature set point;
- thermostat indicator light.

The fan is available in two modifications:

- with the temperature sensor integrated inside the fan air duct (U/U1 option);
- with the external temperature sensor fixed on the cable, 4 m long (Un/U1n/U2n).

Control logic of the fan with the electronic temperature and speed control module.

Set the desired air temperature (thermostat set point) by turning the thermostat control knob. Set the required minimum impeller speed (air flow) by turning the speed control knob. The motor switches to maximum speed (maximum air flow) as the temperature reaches and exceeds the set temperature set point. The motor switches to the pre-set lower speed as the temperature drops down below the temperature set point. To avoid frequent motor speed switches when the air temperature in the duct is equal to the set temperature point, the speed switch delay is activated. There are three switch delay patterns for various cases:

1. The temperature sensor-based switch delay (U option): the motor switches to higher speed as the air temperature exceeds 2 °C above the set thermostat set point. The motor reverts to the preset lower speed as the air temperature drops below the thermostat set point. This pattern is used to keep air temperature to within 2 °C. In this case the motor speed switches are rare.
2. The timer-based switch delay (U1 option): as the air temperature exceeds the set thermostat set point, the motor switches to higher speed and the switch delay timer is activated for 5 min. The motor reverts to lower speed as the air temperature drops down below the thermostat set point and only after 5 minutes timer countdown. This pattern is used for exact air temperature control. The speed switches for the fan with U1 option are more frequent as compared to the operating logic of the fan with U option, however the minimum operating cycle at one speed is 5 minutes.
3. Switching ON/OFF by a temperature sensor (U2 option): when the air temperature exceeds by 2 °C the thermostat actuation set point, the fan starts operating at the set speed. The fan switches off when the temperature drops below the temperature set point.

Designation key

Series	Spigot diameter	Motor		Options
		Polarity	Phase	
VENTS KSA	100; 125; 150; 160; 200	2, 4	E: single phase	<p>U: speed controller with an electronic thermostat and a temperature sensor integrated inside an air duct. Temperature-based operation logic.</p> <p>Un: speed controller with an electronic thermostat and a temperature sensor fixed on a 4-meter cable. Temperature-based operation logic.</p> <p>U1: speed controller with an electronic thermostat and a temperature sensor integrated inside an air duct. Timer-based operation logic.</p> <p>U1n: speed controller with an electronic thermostat and a temperature sensor fixed on a 4-meter cable. Timer-based operation logic.</p> <p>U2n: speed controller with an electronic thermostat and a temperature sensor fixed on a 4-meter cable. Temperature-based switching on/off.</p> <p>R1: power cord with a mains plug.</p> <p>P: integrated smooth speed controller.</p>

Accessories

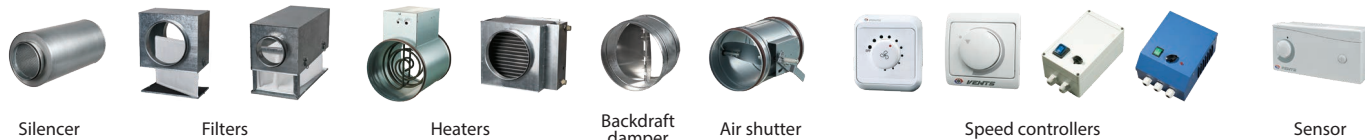

Silencer

Filters

Heaters

Backdraft damper

Air shutter

Speed controllers

Sensor

Technical data

	KSA 100-2E	KSA 125-2E	KSA 150-2E
Voltage [V/50 Hz]	1~230	1~230	1~230
Power [W]	130	155	335
Current [A]	0.60	0.70	1.50
Max. air flow [m ³ /h]	425	505	750
RPM [min ⁻¹]	2870	2870	2870
Noise level at 3 m [dBA]	36.1	38.3	39.4
Transported air temperature [°C]	-25...+40	-25...+40	-25...+40
SEC class	C	C	D
Protection rating	IPX4	IPX4	IPX4

Technical data

	KSA 160-2E	KSA 200-4E
Voltage [V/50 Hz]	1~230	1~230
Power [W]	335	115
Current [A]	1.50	0.50
Max. air flow [m ³ /h]	750	640
RPM [min ⁻¹]	2870	1350
Noise level at 3 m [dBA]	37.9	29.1
Transported air temperature [°C]	-25...+40	-25...+40
SEC class	D	C
Protection rating	IPX4	IPX4

Fan overall dimensions

Type	Dimensions [mm]					Mass [kg]
	∅D	B	H	L	P	
KSA 100-2E	99	184	308	310	48	4.22
KSA 125-2E	123	204	308	310	48	4.57
KSA 150-2E	148	231	343	358	48	6.28
KSA 160-2E	158	231	343	358	48	6.28
KSA 200-4E	198	282	408	445	48	8.25

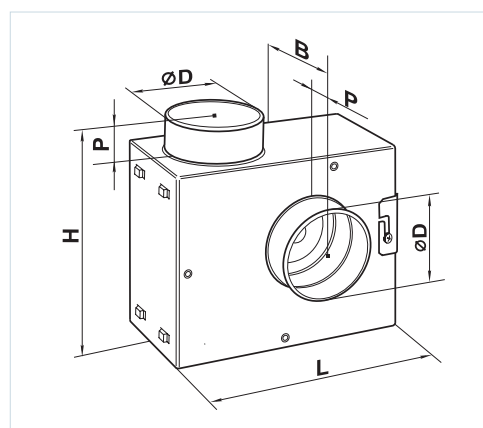

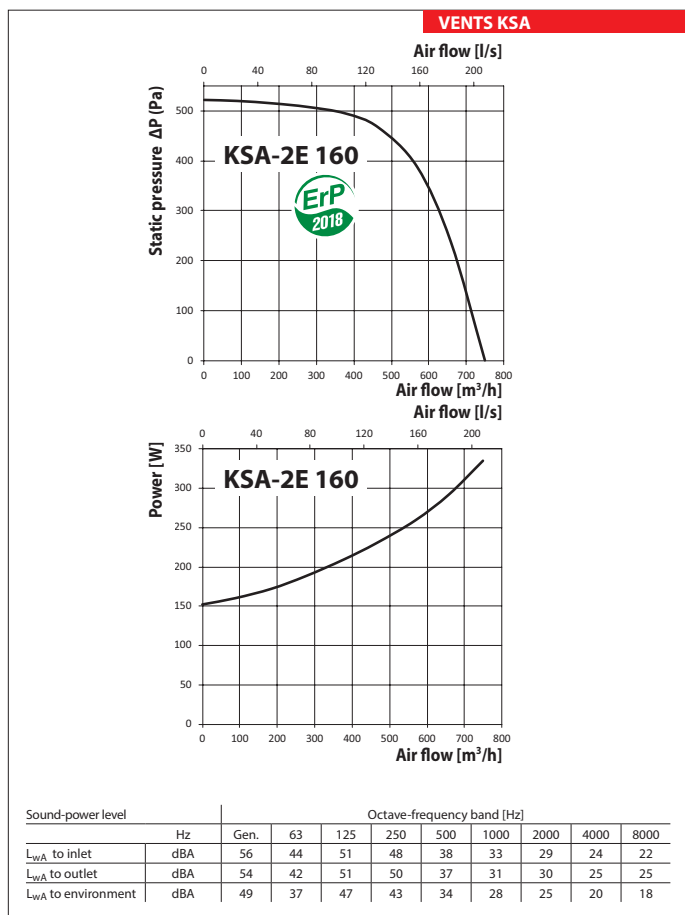
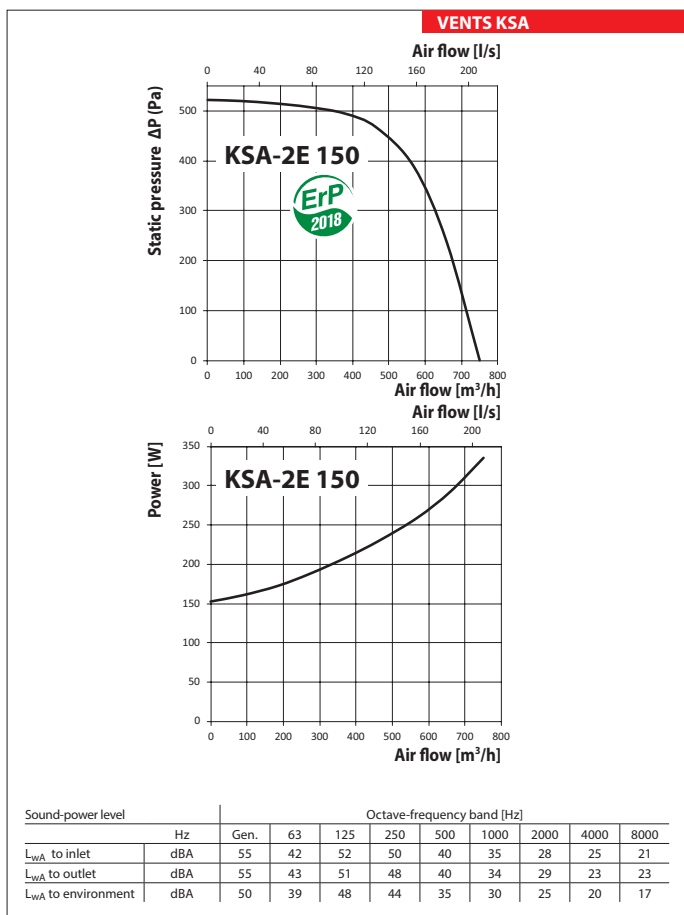
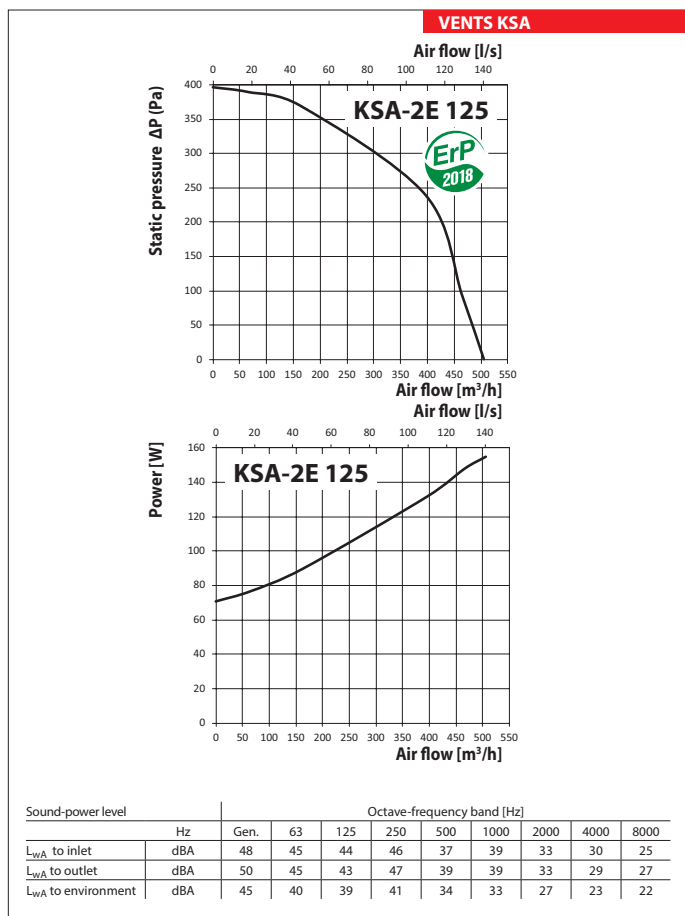
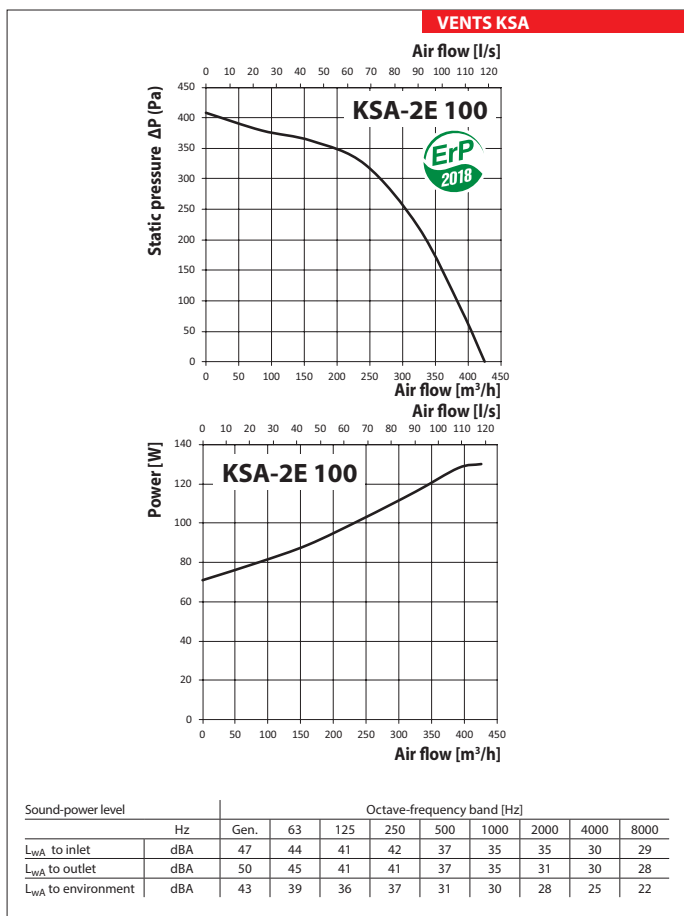

VENTS KSA

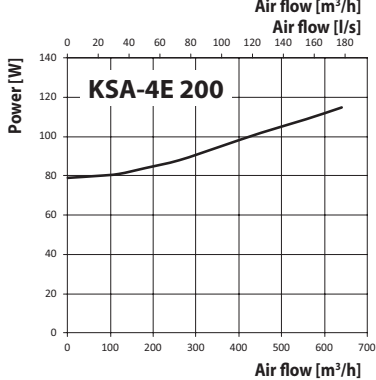
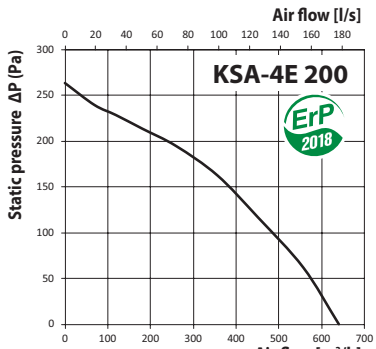

Sound-power level	Hz	Octave-frequency band [Hz]								
		Gen.	63	125	250	500	1000	2000	4000	8000
L _{WA} to inlet	dBA	43	39	38	38	31	29	20	17	14
L _{WA} to outlet	dBA	43	36	38	34	34	27	23	18	18
L _{WA} to environment	dBA	38	33	35	31	27	22	16	13	11

FAN SERIES VENTS KSA

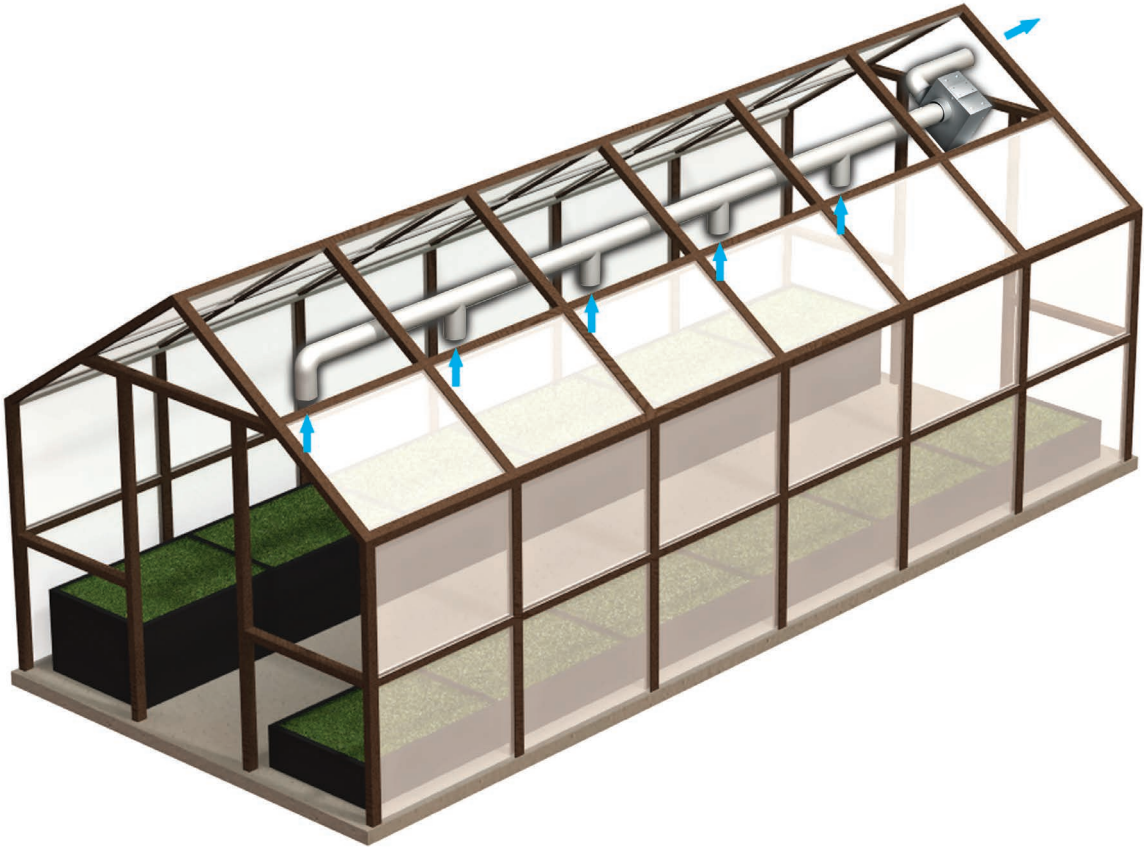

KSA fan greenhouse ventilation example