

Series
VENTS KSB K2



Inline centrifugal fans in heat- and sound-insulated casing with air flow up to **7000 m³/h**

■ Purpose

KSB fan design allows to use them in supply and exhaust ventilation systems for commercial, office and other public or industrial premises with high requirements to the noise level and with limited space for mounting. For example, the unit design includes a possibility of space-restricted installation above suspended ceilings. They are designed for mounting into Ø 100-500 mm air ducts.

■ Design

The fan casing is made of aluzinc. For easy installation and operation, the top cover of the fan is secured with a special lock. Heat- and sound insulation is made of non-combustible 50 mm mineral wool layer. To ensure better noise absorption, the inner surface of the insulation is made of a perforated metal sheet. The round connecting spigots are rubber sealed.



■ Motor

The fans are equipped with asynchronous motors with an external rotor and centrifugal impellers with backward curved blades. The motors are equipped with an integrated overheating protection with automatic restart. The use of ball bearings with specially selected lubricating oil guarantees low noise and makes the fan completely maintenance-free.

■ Speed control

Smooth or step speed control by means of a thyristor or autotransformer speed controller. Several fans can be connected to one controller, provided that the total power and operating current do not exceed the nominal parameters of the controller.

■ Mounting

The round inline fans are designed for connection to round air ducts. The fans are installed at an air duct junction. The use of flexible connectors requires fixation of the fan on the building structure by means of supports, mounts or fixing brackets. The fan can be fixed in any position with respect to the air flow direction indicated by the arrow on the fan casing. While mounting the fan provide enough access for servicing and repair operations.

Designation key

Series	Spigot diameter	Modification	Motor	Options
VENTS KSB	100; 125; 150; 160; 200; 250; 315; 355; 400; 450; 500	K2: heat- and sound-insulated casing	S: high-powered motor Q: low noise and low-powered motor	R1: power cord with a mains plug

Accessories



Silencer

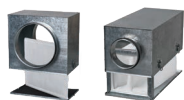

Filters

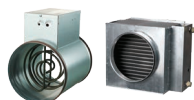

Heaters



Backdraft damper



Air shutter



Speed controllers
RSA5D-...-T



RS-...-T



RS-...-T

Overall dimensions

Model	Dimensions [mm]							Mass [kg]
	∅D	B	B1	H	L	L1	L2	
KSB 100 K2	99	420	228	258	517	507	414	13
KSB 125 K2	124	420	228	258	517	507	414	13
KSB 125 K2 S	124	533	333	280	630	617	525	19
KSB 150 K2	149	470	278	282	566	586	493	17
KSB 160 K2	159	470	278	282	566	586	493	17
KSB 200 K2	198	535	357.5	355	632	628	535	22.6
KSB 250 K2	248	677	537	429	774	759	666	33
KSB 315 K2 S	313	760	560	460	857	747	666	48
KSB 355 K2	354	830	641	500	927	885	804	58
KSB 400 K2	399	927	737	578	1024	957	876	78.5
KSB 450 K2 Q	449	1049	858	607	1152	1049	968	84
KSB 500 K2	499	1203	993	744	1300	1263	1182	129

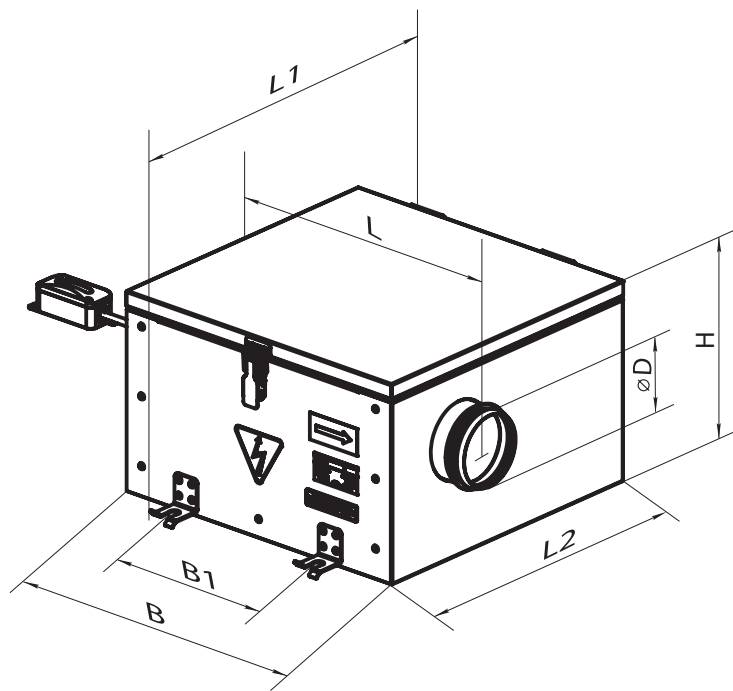

FAN SERIES VENTS KSB K2

Technical data

	KSB 100 K2	KSB 125 K2	KSB 125 K2 S	KSB 150 K2
Unit voltage [V/50 Hz]	1~230	1~230	1~230	1~230
Power [W]	58	61	88	84
Current [A]	0.25	0.28	0.37	0.37
Maximum air flow [m³/h]	285	330	484	485
RPM [min⁻¹]	2530	2560	2670	2620
Sound pressure level at 3 m distance [dBA]	34	35	40	38
Transported air temperature [°C]	-25...+55	-25...+55	-25...+55	-25...+55
Ingress protection rating	IPX4	IPX4	IPX4	IPX4
SEC class	C	C	C	C

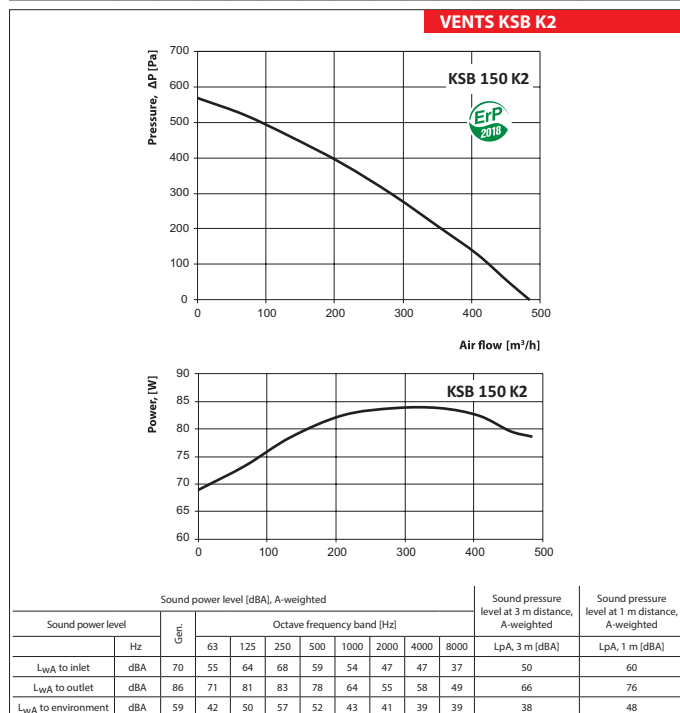
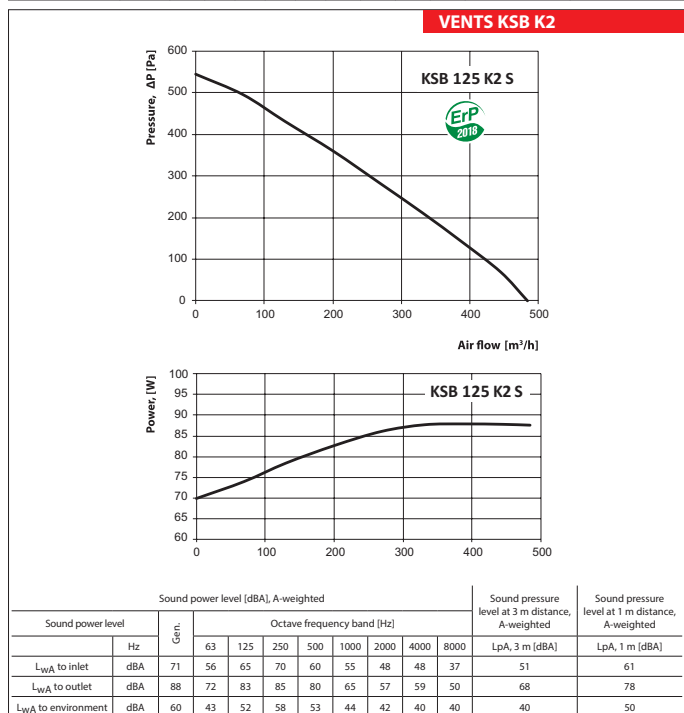
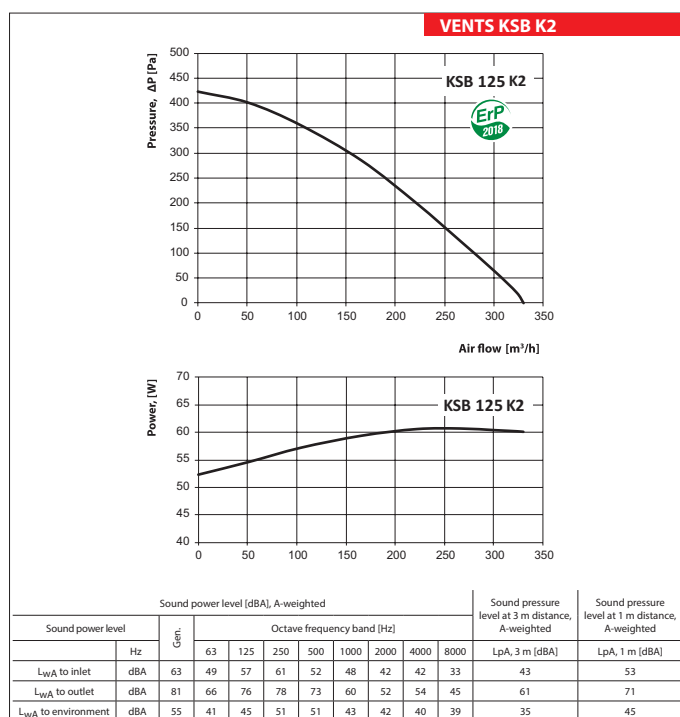
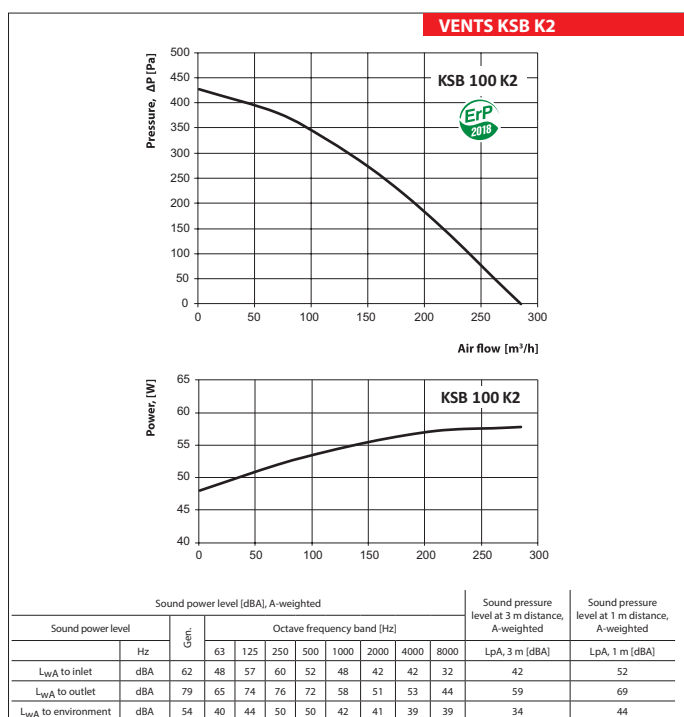

Technical data

	KSB 160 K2	KSB 200 K2	KSB 250 K2	KSB 315 K2 S
Unit voltage [V/50 Hz]	1~230	1~230	1~230	3~400
Power [W]	86	164	320	654
Current [A]	0.38	0.71	1.40	1.10
Maximum air flow [m ³ /h]	500	770	1515	2700
RPM [min ⁻¹]	2670	2580	2615	2600
Sound pressure level at 3 m distance [dBA]	38	42	45	48
Transported air temperature [°C]	-25...+55	-25...+55	-25...+55	-25...+55
Ingress protection rating	IPX4	IPX4	IPX4	IPX4
SEC class	C	C	-	-

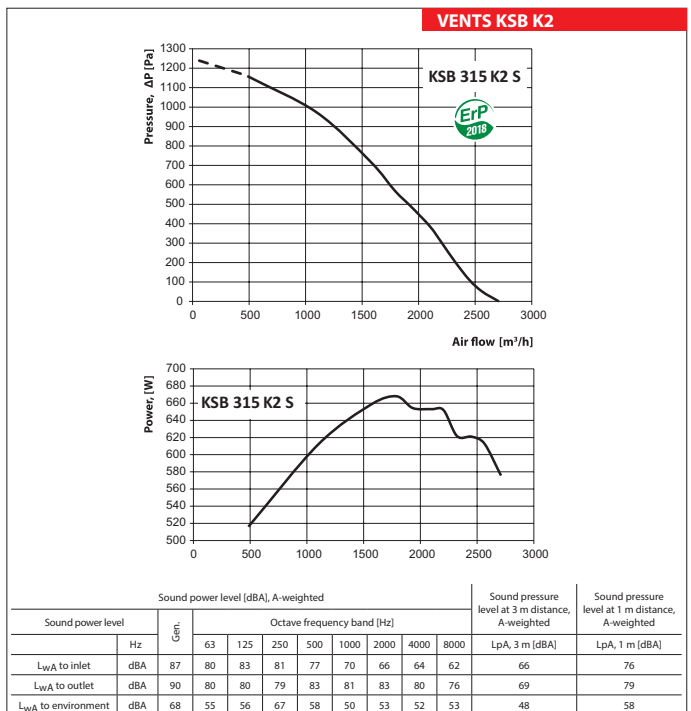
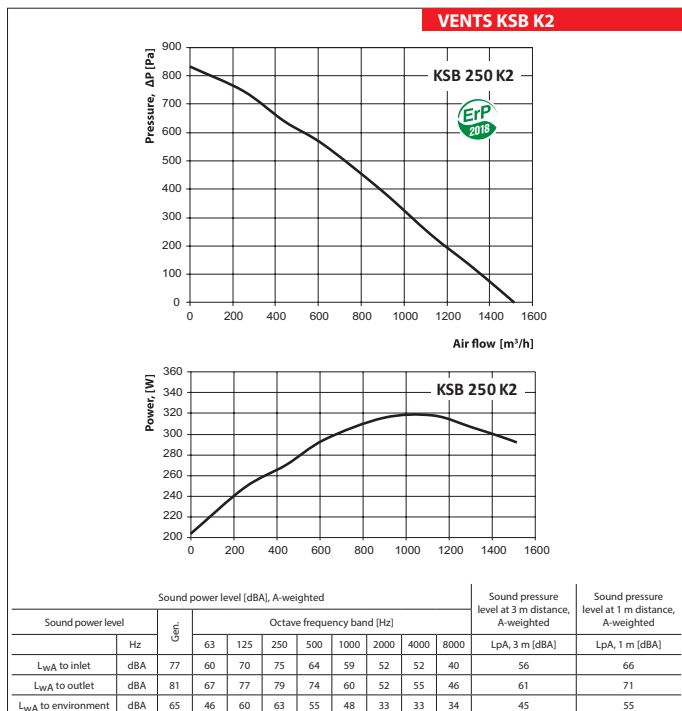
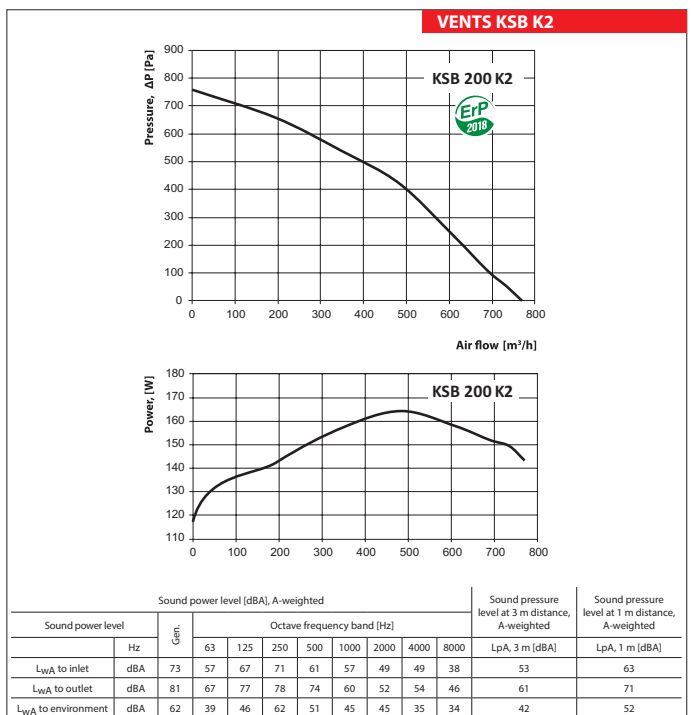
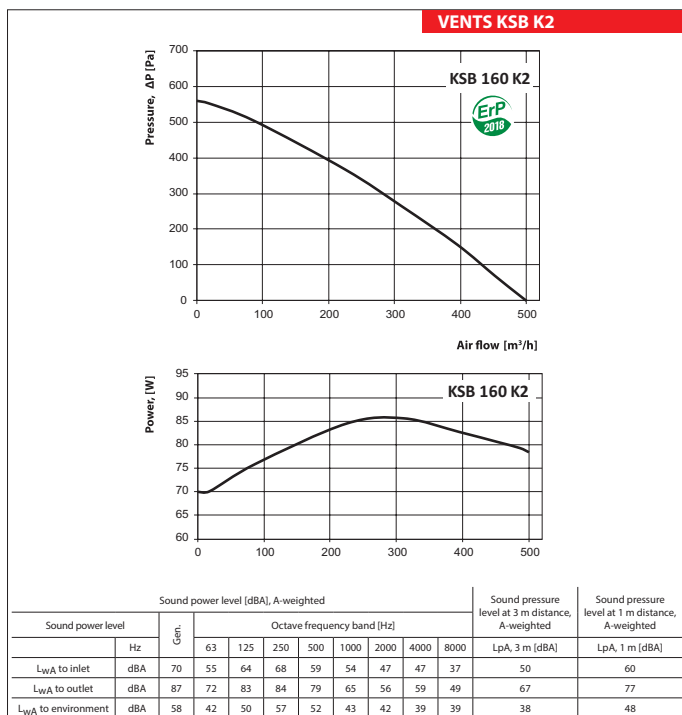

Technical data

	KSB 355 K2	KSB 400 K2		KSB 450 K2 Q
Unit voltage [V]	1~230	1~230		1~230
Frequency [Hz]	50	50	60	50
Power [W]	202	427	663	482
Current [A]	0.89	1.87	2.91	2.13
Maximum air flow [m³/h]	2235	3800	4100	3750
RPM [min⁻¹]	1330	1451	1711	1350
Sound pressure level at 3 m distance [dBA]	48	49	50	50
Transported air temperature [°C]	-25...+55	-25...+55	-25...+55	-25...+55
Ingress protection rating	IPX4	IPX4	IPX4	IPX4

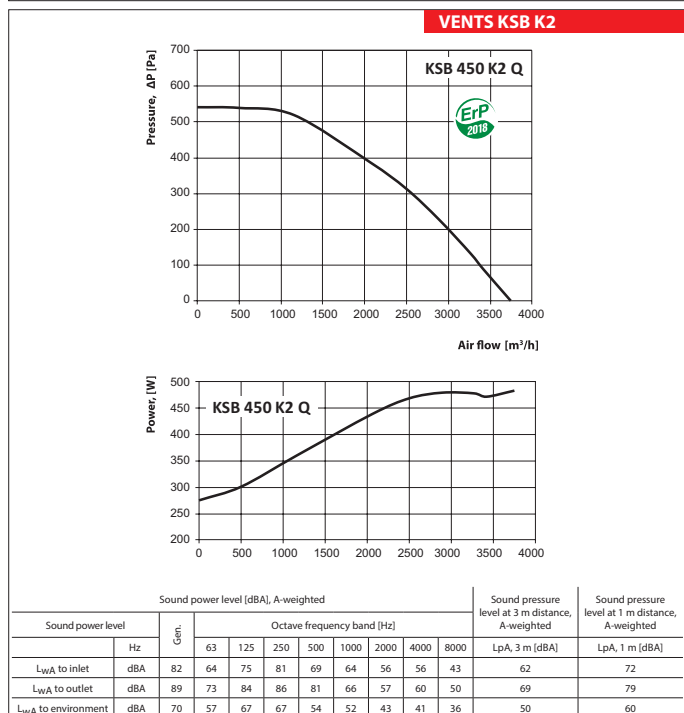
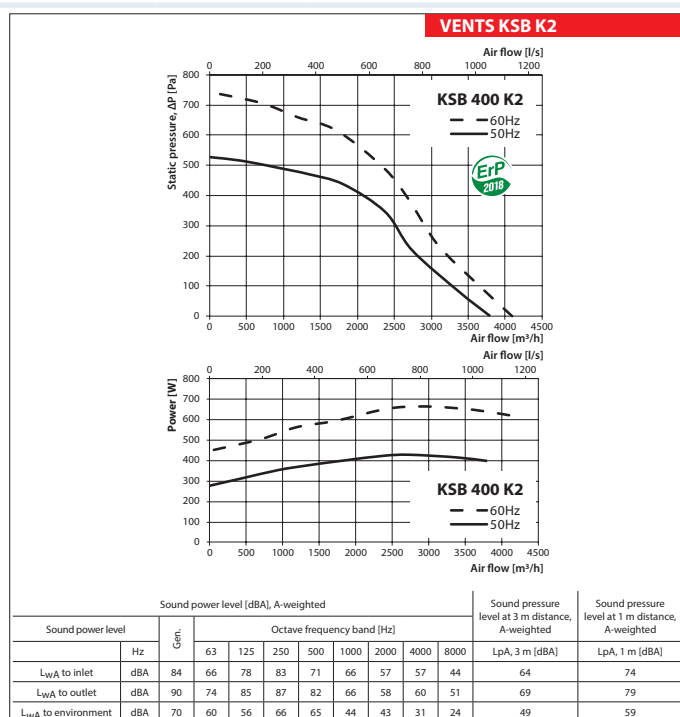
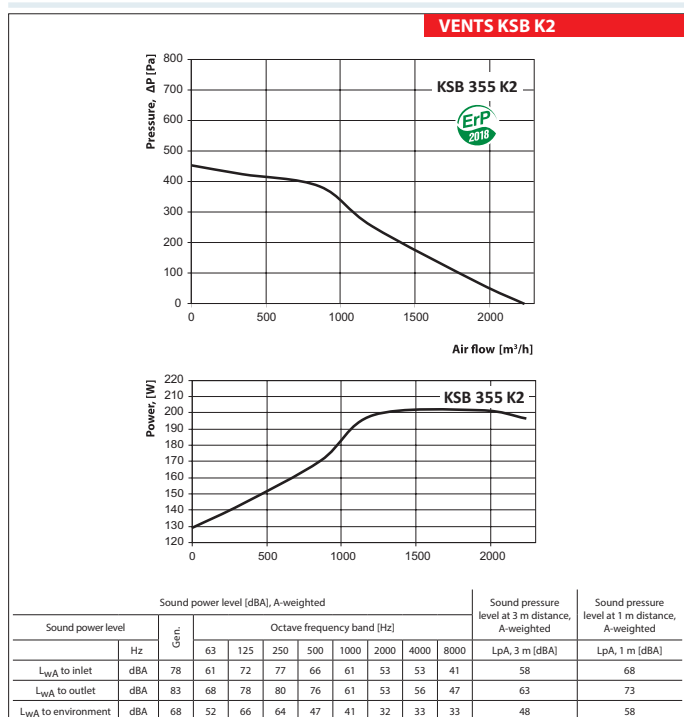

Technical data

	KSB 500 K2 (Δ)	KSB 500 K2 (Y)
Unit voltage [V/50 Hz]	1~230	3~400
Power [W]	730	780
Current [A]	2.82	1.60
Maximum air flow [m³/h]	7000	6720
RPM [min ⁻¹]	980	948
Sound pressure level at 3 m distance [dBA]	56	54
Transported air temperature [°C]	-25...+55	-25...+55
Ingress protection rating	IPX4	IPX4

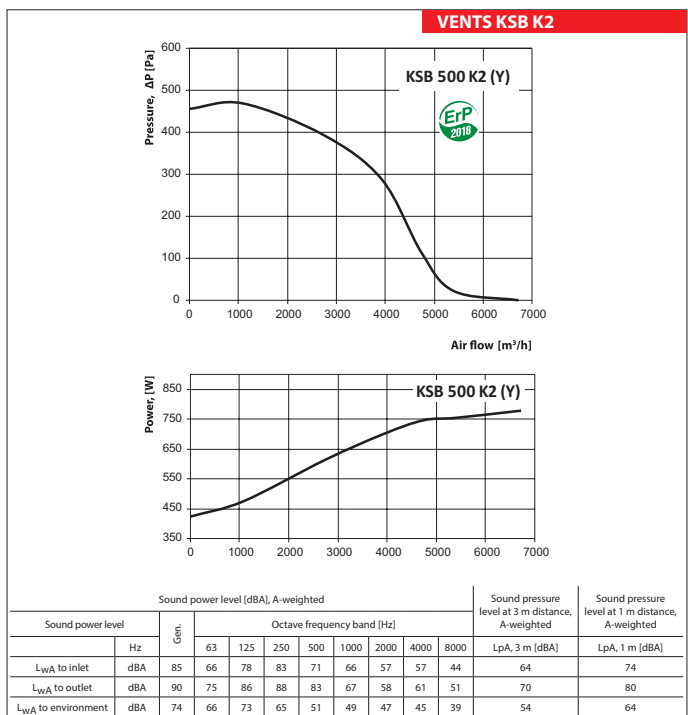
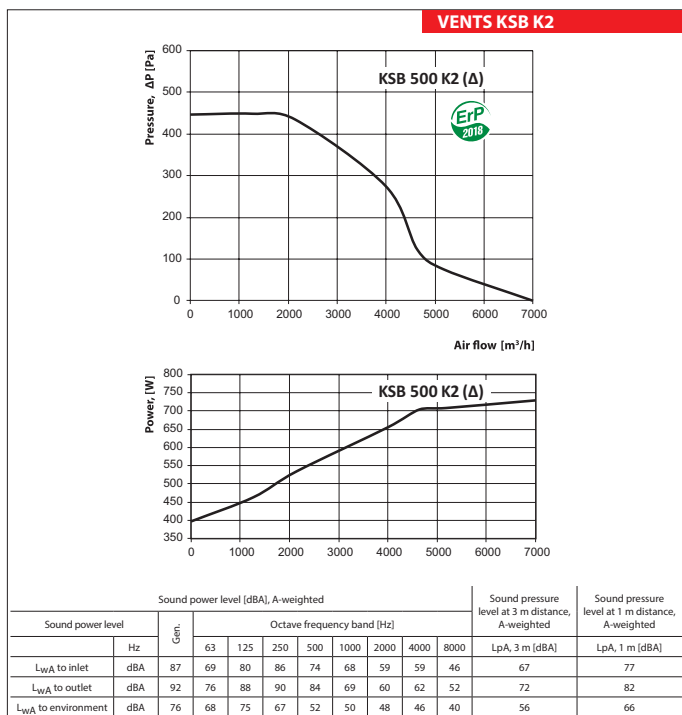

FAN SERIES VENTS KSB K2