

Series  
**VENTS KSD**



Inline centrifugal fan for round ducts in heat- and sound-insulated casing. Air flow up to **3930 m<sup>3</sup>/h**

**Application**

KSD fan is designed for use in supply and exhaust ventilation systems for commercial, office and other public or industrial premises with high requirements to noise level.

**Design**

The fan casing is made of galvanized steel plate and heat- and sound-insulated material. The connecting flanges are fitted with rubber seals. The fan series KSD 315/250x2 are equipped with two intake flanges Ø 250 mm to facilitate synchronous air exhaust from several areas or rooms.

**Motor**

Four- or six-pole external rotor asynchronous motor equipped with double-inlet impeller with forward curved blades. The motor has overheating protection with automatic restart. Due to ball bearings with specially selected grease type the fan is maintenance-free and distinguished by low-noise operation.

**Speed control**

Smooth or step speed control with a thyristor or autotransformer speed controller. Several fans may be connected to one speed controller provided that the total power and operating current do not exceed the rated speed controller parameters.

**Mounting**

The inline fans are designed for mounting with round air ducts.

In case of mounting with flexible connectors the fan is attached to a building with supports, suspension or fixing brackets. The fan is suitable for mounting in any position in compliance with the air motion direction in the system (shown with pointer on the fan casing). While mounting sufficient space for fan maintenance must be provided.

**Designation key**

Series	Flange diameter			Motor modification			Options
	Exhaust flange diameter	Intake flange diameter*	Number of intake flanges	Motor	Number of poles	Phase	
<b>VENTS KSD</b>	250 315	/ 250	x 2	_: basic motor S: High-powered motor	- 4; 6	E: single phase	<p><b>U:</b> speed controller with an electronic thermostat and a temperature sensor integrated inside an air duct. Temperature-based operation logic.</p> <p><b>Un:</b> speed controller with an electronic thermostat and a temperature sensor fixed on a 4-meter cable. Temperature-based operation logic.</p> <p><b>U1:</b> speed controller with an electronic thermostat and a temperature sensor integrated inside an air duct. Timer-based operation logic.</p> <p><b>U1n:</b> speed controller with an electronic thermostat and a temperature sensor fixed on a 4-meter cable. Timer-based operation logic.</p> <p><b>U2n:</b> speed controller with an electronic thermostat and a temperature sensor fixed on a 4-meter cable. Temperature-based switching on/off.</p> <p><b>R1:</b> power cord with a mains plug.</p> <p><b>P:</b> integrated smooth speed controller.</p>

\* no intake flange diameter if it is equal to the exhaust flange diameter

**Accessories**



Silencer

Filters

Heaters

Backdraft damper

Air shutter

Speed controllers

Sensor

**■ The fan with electronic temperature and control module (U option).**

The ideal solution for ventilation of the premises requiring permanent temperature control, i.e. greenhouses. The fan with the electronic temperature and speed control module provides automatic control of the motor speed (air flow) depending on air temperature in the air duct or in the room.

The front panel of the electronic module has the following control knobs:

- speed control knob for setting the motor speed;
- thermostat control knob for setting the temperature set point;
- thermostat indicator light.

The fan is available in two modifications:

- with the temperature sensor integrated inside the fan air duct (U/U1 option);
- with the external temperature sensor fixed on the cable, 4 m long (Un/U1n/U2n).

**■ Control logic of the fan with the electronic temperature and speed control module.**

Set the desired air temperature (thermostat set point) by turning the thermostat control knob. Set the required minimum impeller speed (air flow) by turning the speed control knob. The motor switches to maximum speed (maximum air flow) as the temperature reaches and exceeds the set temperature set point. The motor switches to the pre-set lower speed as the temperature drops down below the temperature set point. To avoid frequent motor speed switches when the air temperature in the duct is equal to the set temperature point, the speed switch delay is activated. There are three switch delay patterns for various cases:

1. The temperature sensor-based switch delay (U option): the motor switches to higher speed as the air temperature exceeds 2 °C above the set thermostat set point. The motor reverts to the preset lower speed as the air temperature drops below the thermostat set point.

This pattern is used to keep air temperature to within 2 °C. In this case the motor speed switches are rare.

2. The timer-based switch delay (U1 option): as the air temperature exceeds the set thermostat set point, the motor switches to higher speed and the switch delay timer is activated for 5 min. The motor reverts to lower speed as the air temperature drops down below the thermostat set point and only after 5 minutes timer countdown. This pattern is used for exact air temperature control. The speed switches for the fan with U1 option are more frequent as compared to the operating logic of the fan with U option, however the minimum operating cycle at one speed is 5 minutes.

3. Switching ON/OFF by a temperature sensor (U2 option): when the air temperature exceeds by 2 °C the thermostat actuation set point, the fan starts operating at the set speed. The fan switches off when the temperature drops below the temperature set point.

**■ Example for temperature sensor delay:**

Initial conditions:

- rated speed is set as 60 % of the maximum speed
- operating threshold is set as 25 °C
- air temperature in the duct is 20 °C

Fan operates with the rated speed =60 %



• air temperature in the duct rises  
fan operates with the rated speed =60 %



• air temperature in the duct reaches 27 °C  
Fan switches to the speed =100 %



• air temperature in the duct goes down  
fan operates with the speed =100 %



• temperature in the duct reaches 25 °C again  
fan switches to the preset rated speed =60 %

**■ Example for timer delay:**

Initial conditions:

- set rotation speed = 60 % of maximum speed
- set operating threshold =25 °C
- air temperature in the duct =20 °C

motor operates with the motor speed =60 %



- the temperature in the duct rises, reaches 25 °C and keeps rising



fan switches to the maximum speed =100 % and the delay timer switches for 5 minutes on



- the temperature in the duct goes down  
the fan operates with the maximum speed =100 %



- the temperature in the duct reaches 25 °C and keeps going down



after the timer stops, the motor switches to the preset rated speed (=60 %). After the speed switch the timer switches again for 5 minutes on.



- the temperature in the duct rises, reaches 25 °C and keeps rising



after the timer stops, the motor switches to the maximum speed (=100 %). After the speed switch the timer switches again for 5 minutes on.

Thus, in timer delay pattern the delay timer activates every time the fan speed changes.



Optional supply with a fastening eye

Fan overall dimensions

Type	Dimensions [mm]											Mass [kg]	Fig.no.
	∅D	∅d	B	B1	H	H1	H2	H4	L	L1	L2		
KSD 250-6E	248	20	453	400	433	298	216	470	568	470	400	30	1
KSD 250 S-6E	248	20	503	450	483	340	241	520	638	540	470	31.3	1
KSD 250-4E	248	20	453	400	433	298	216	470	568	470	400	30	1
KSD 250 S-4E	248	20	503	450	483	340	241	520	638	540	470	31.3	1
KSD 315-6E	313	20	600	550	500	340	251	537	680	580	510	31	1
KSD 315 S-6E	313	25	670	620	610	450	306	658	825	725	660	45	1
KSD 315-4E	313	20	600	550	500	340	251	537	680	580	510	33	1
KSD 315 S-4E	313	20	650	610	530	367	266	567	735	635	570	38	1

Fan overall dimensions

Type	Dimensions [mm]															Mass [kg]	Fig.no.
	∅D	∅D1	∅d	B	B1	B2	B3	H	H1	H2	H3	H4	L	L1	L2		
KSD 315/250x2-6E	313	248	20	600	550	171	431	500	340	176	326	537	680	580	510	31	2
KSD 315/250x2 S-6E	313	248	25	670	620	216	457	610	450	186	427	658	825	725	660	45	2
KSD 315/250x2-4E	313	248	20	600	550	171	431	500	340	176	326	537	680	580	510	33	2
KSD 315/250x2 S-4E	313	248	20	650	610	188	465	530	367	186	346	567	735	635	570	38	2

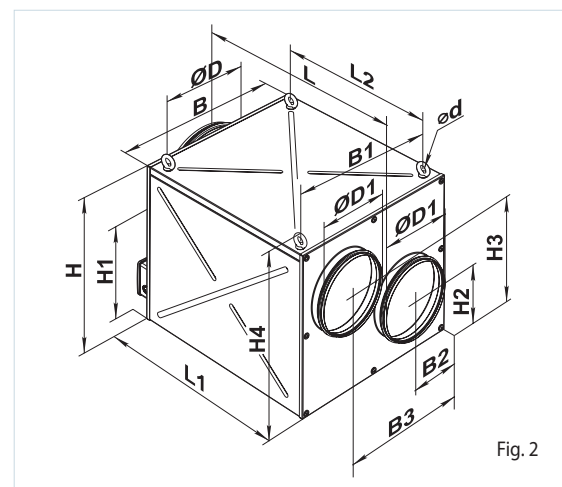
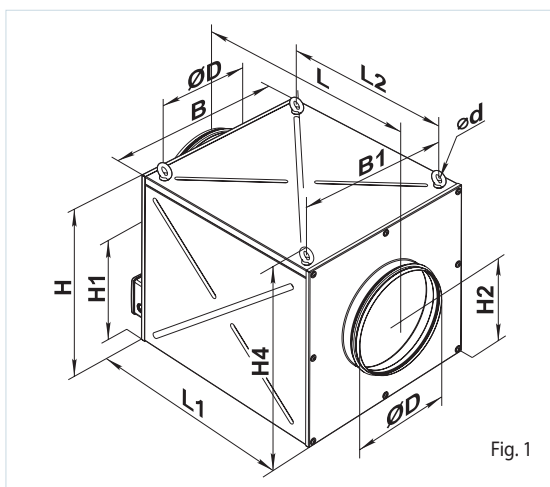

**Technical data**

	<b>KSD 250-6E</b>	<b>KSD 250 S-6E</b>	<b>KSD 250-4E</b>	<b>KSD 250 S-4E</b>
Voltage [V/50 Hz]	1~230	1~230	1~230	1~230
Power [W]	120	311	243	617
Current [A]	0.55	1.36	1.06	2.69
Max. air flow [m³/h]	1210	1680	1520	2470
RPM [min <sup>-1</sup> ]	860	940	1320	1465
Noise level at 3 m [dBA]	40	41	44	46
Transported air temperature [°C]	-20...+50	-20...+50	-20...+50	-20...+50
Protection rating	IPX4	IPX4	IPX4	IPX4

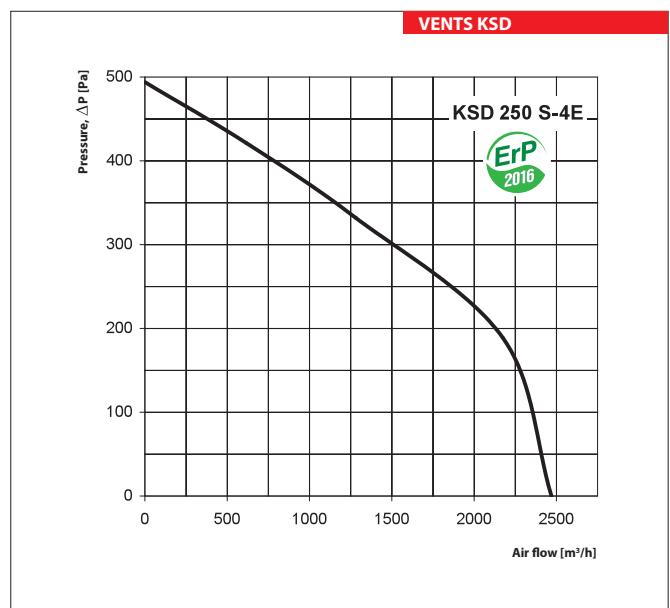
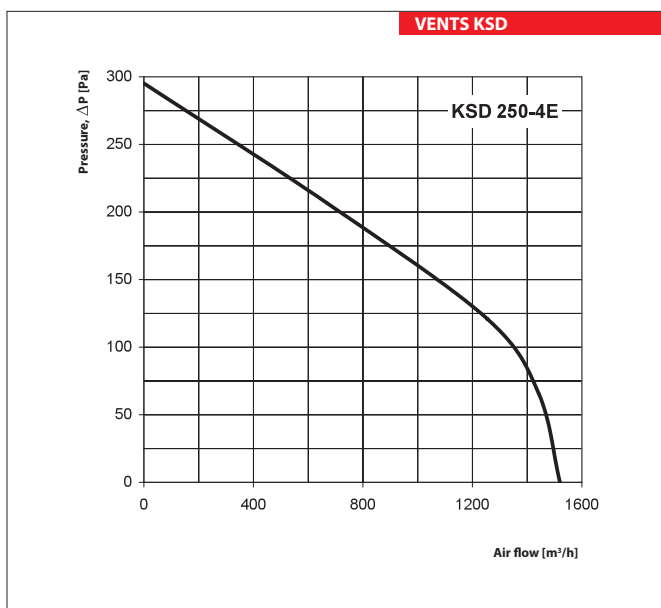
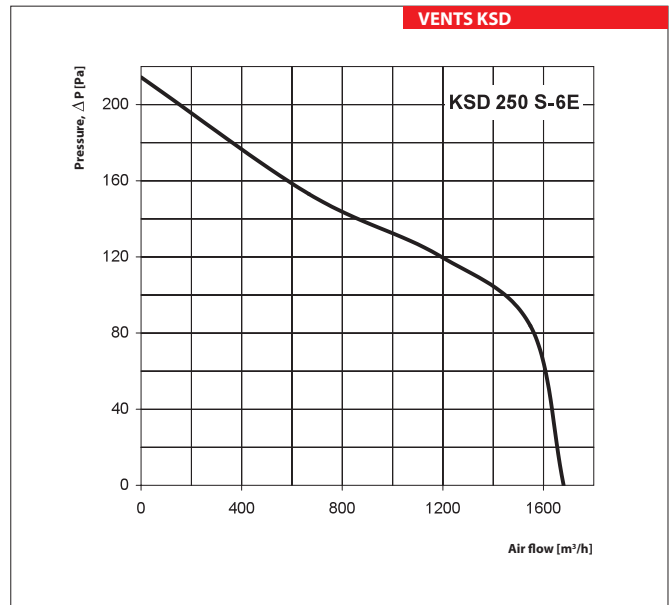
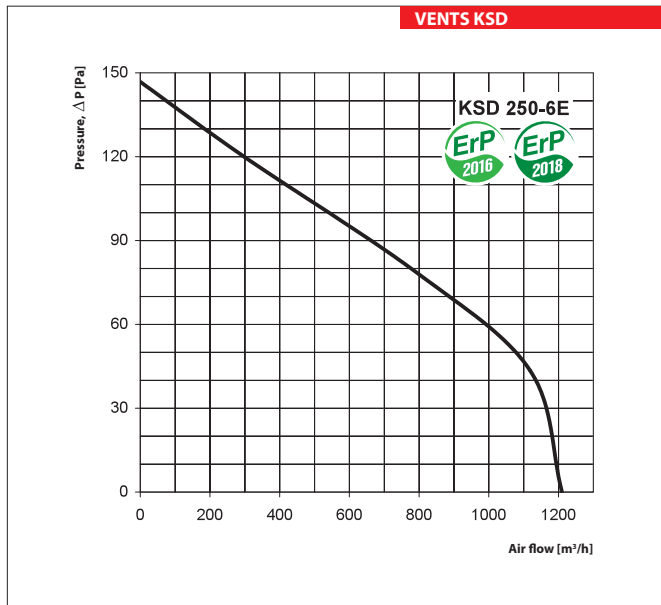

FAN SERIES VENTS KSD

Technical data

	KSD 315-6E	KSD 315 S-6E	KSD 315-4E	KSD 315 S-4E
Voltage [V/50 Hz]	1~230	1~230	1~230	1~230
Power [W]	402	800	723	931
Current [A]	2.04	4.59	3.15	4.18
Max. air flow [m <sup>3</sup> /h]	2460	3470	3200	3520
RPM [min <sup>-1</sup> ]	920	960	1350	1430
Noise level at 3 m [dBA]	42	43	45	47
Transported air temperature [°C]	-20...+50	-20...+50	-20...+50	-20...+50
Protection rating	IPX4	IPX4	IPX4	IPX4

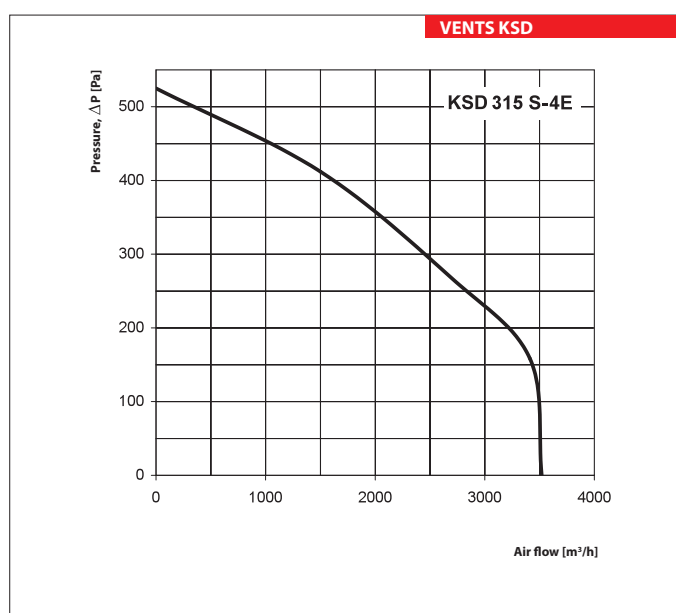
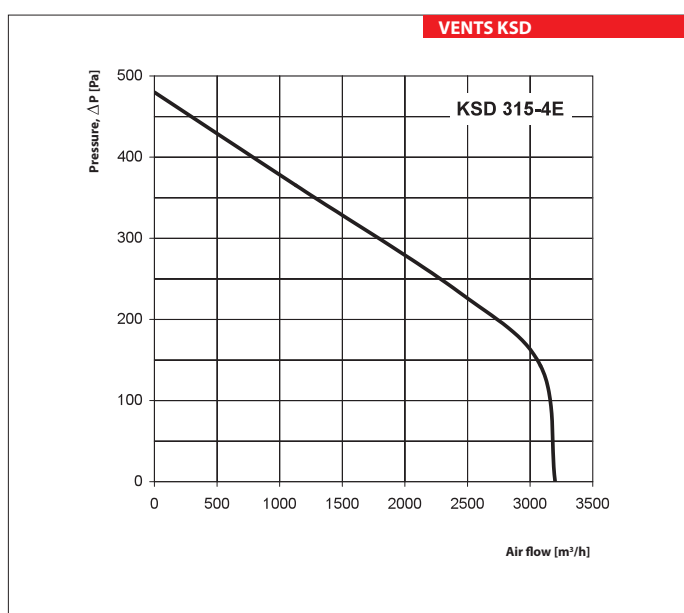
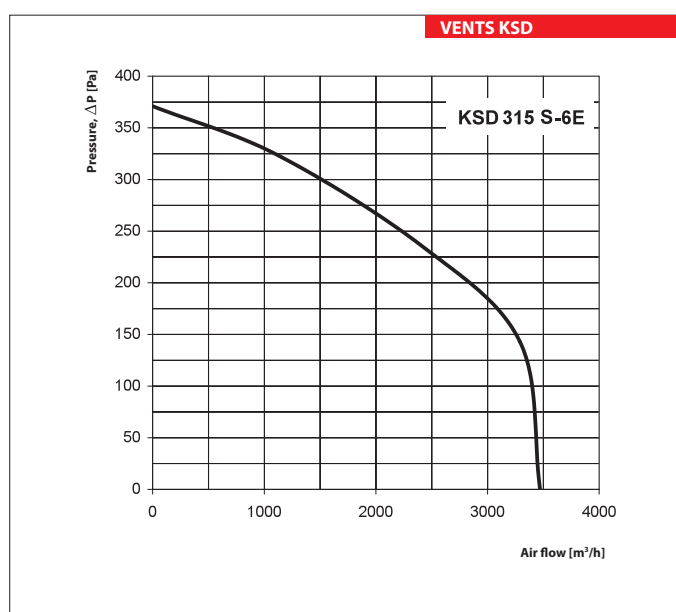
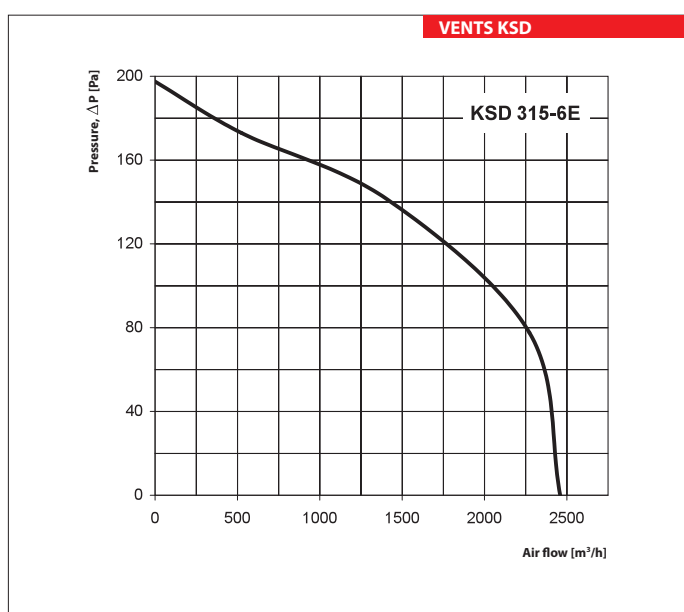

**Technical data**

	<b>KSD 315/250x2-6E</b>	<b>KSD 315/250x2 S-6E</b>	<b>KSD 315/250x2-4E</b>	<b>KSD 315/250x2 S-4E</b>
Voltage [V/50 Hz]	1~230	1~230	1~230	1~230
Power [W]	427	953	764	1066
Current [A]	2.13	5.06	3.36	4.78
Max. air flow [m³/h]	2610	3850	3420	3930
RPM [min <sup>-1</sup> ]	955	970	1390	1455
Noise level at 3 m [dBA]	42	43	45	47
Transported air temperature [°C]	-20...+50	-20...+50	-20...+50	-20...+50
Protection rating	IPX4	IPX4	IPX4	IPX4

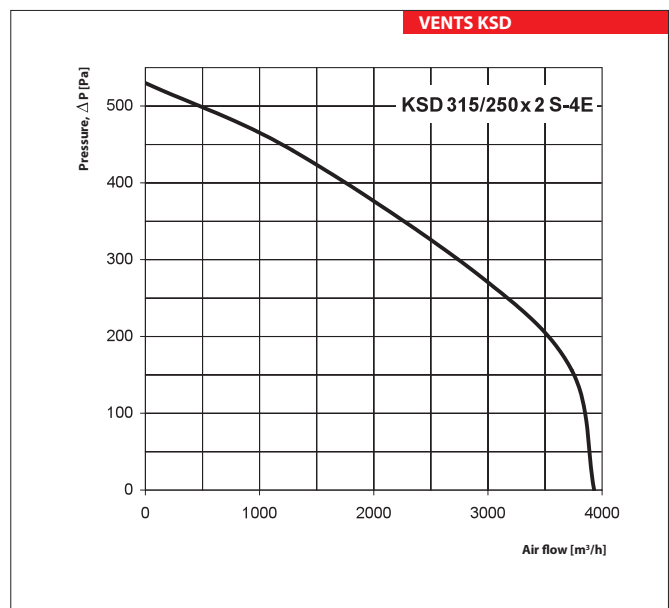
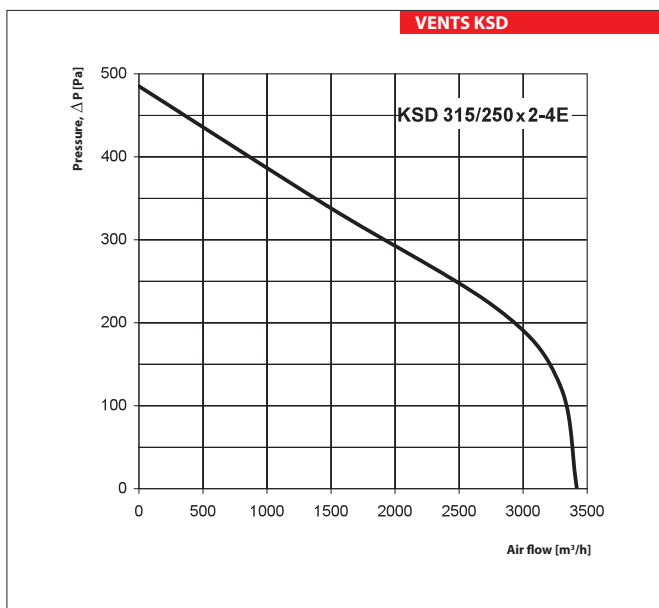
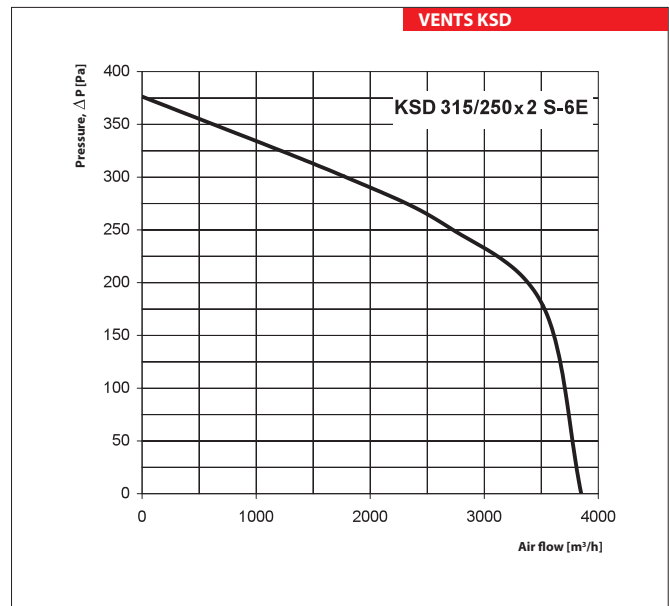
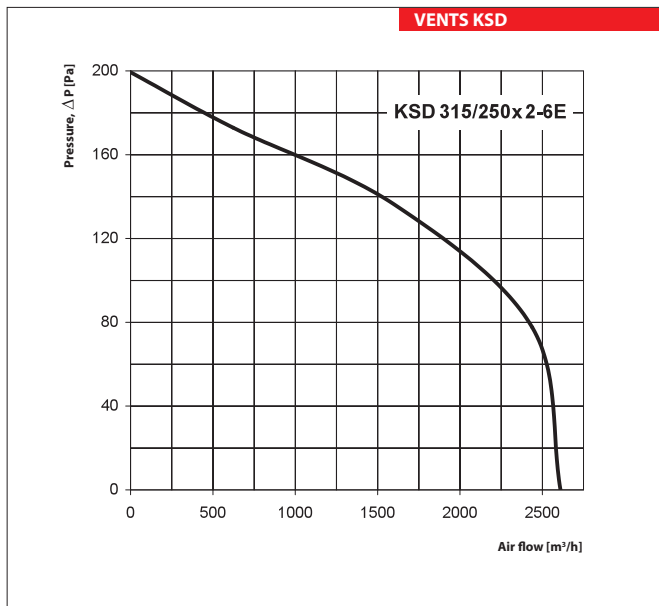

FAN SERIES VENTS KSD