

KV1 TwinFresh Easy

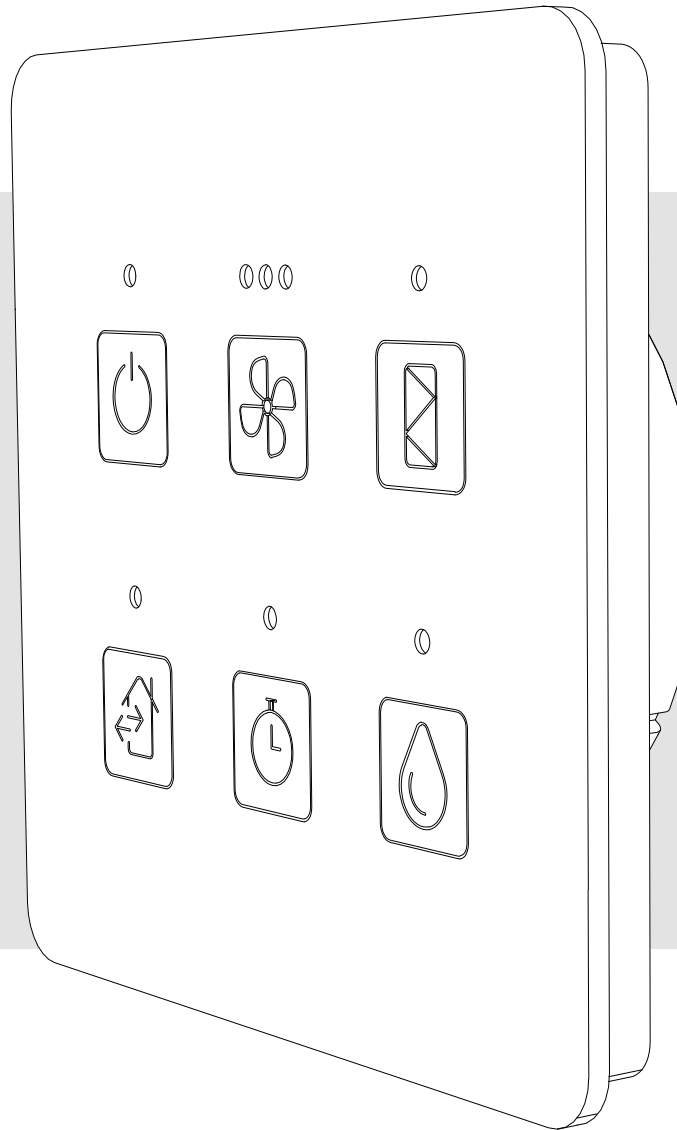

Control panel

CONTENTS

Safety requirements.....	2
Purpose.....	4
Delivery set.....	4
Technical data.....	4
Installation and connection.....	5
Control.....	7
Storage and transportation regulations.....	9
Manufacturer's warranty.....	10
Certificate of acceptance.....	11
Seller information.....	11
Installation certificate.....	11
Warranty card.....	11

This user's manual is a main operating document intended for technical, maintenance, and operating staff.

The manual contains information about purpose, technical details, operating principle, design, and installation of the KV1 TwinFresh Easy unit and all its modifications.

Technical and maintenance staff must have theoretical and practical training in the field of ventilation systems and should be able to work in accordance with workplace safety rules as well as construction norms and standards applicable in the territory of the country.

SAFETY REQUIREMENTS

This unit is not intended for use by persons (including children) with reduced physical, sensory or mental capabilities, or lack of experience and knowledge, unless they have been given supervision or instruction concerning use of the unit by a person responsible for their safety. Children should be supervised to ensure that they do not play with the unit.

This appliance can be used by children aged from 8 years and above and persons with reduced physical, sensory or mental capabilities or lack of experience and knowledge if they have been given supervision or instruction concerning use of the appliance in a safe way and understand the hazards involved.

Cleaning and user maintenance shall not be done by children without supervision.

Children shall not play with the appliance.

Ensure that the unit is switched off from the supply mains before removing the guard.

All operations described in this manual must be performed by qualified personnel only, properly trained and qualified to install, make electrical connections and maintain ventilation units.

Do not attempt to install the product, connect it to the mains, or perform maintenance yourself. This is unsafe and impossible without special knowledge.

Disconnect the power supply prior to any operations with the unit.

All user's manual requirements as well as the provisions of all the applicable local and national construction, electrical, and technical norms and standards must be observed when installing and operating the unit.

Disconnect the unit from the power supply prior to any connection, servicing, maintenance, and repair operations.

While mounting the unit, avoid compression of the casing!

Misuse of the unit and any unauthorised modifications are not allowed.

Do not expose the unit to adverse atmospheric agents (rain, sun, etc.).

Do not use the unit in a hazardous or explosive environment containing spirits, gasoline, insecticides, etc.

Do not sit on the unit and do not put objects on it.

The information in this user's manual was correct at the time of the document's preparation. The Company reserves the right to modify the technical characteristics, design, or configuration of its products at any time in order to incorporate the latest technological developments.

Never touch the unit with wet or damp hands.

Never touch the unit when barefoot.

BEFORE INSTALLING ADDITIONAL EXTERNAL DEVICES, READ THE APPROPRIATE USER MANUALS.



THE PRODUCT MUST BE DISPOSED SEPARATELY AT THE END OF ITS SERVICE LIFE.

DO NOT DISPOSE THE UNIT AS UNSORTED DOMESTIC WASTE.

PURPOSE

The wall-mounted sensor control panel is designed to be used as a part of the **TwinFresh Easy** domestic air handling unit control system. The control panel is a component part and is not designed for independent operation. The unit is rated for continuous operation.

DELIVERY SET

Name	Number
Control panel	1 pc.
User's manual	1 pc.
Packing box	1 pc.

TECHNICAL DATA

Unit voltage DC [V]	12-32
Current per 24 V DC [A]	0,1
Ambient temp. [°C]	+10...+45
Ambient humidity range [%]	10-80 (no cond.)
Weight [g]	60
Protection class	IP20

OVERALL AND CONNECTING DIMENSIONS [MM]

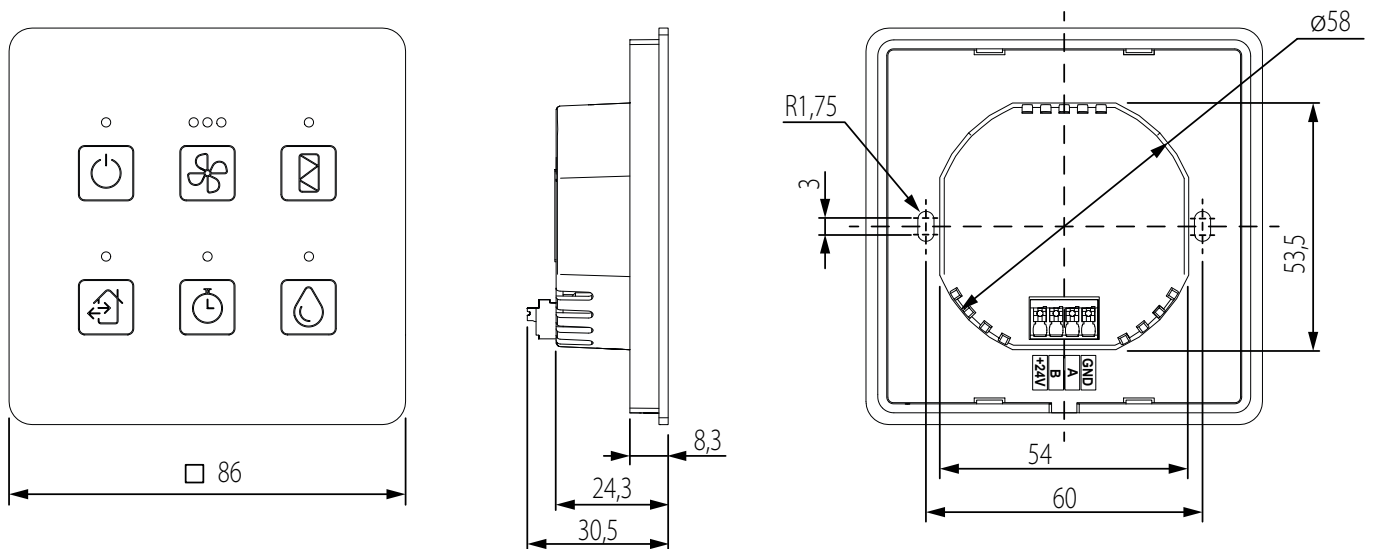

INSTALLATION AND CONNECTION



CHECK THAT THE UNIT IS DISCONNECTED FROM POWER SUPPLY PRIOR TO ANY OPERATIONS!



DO NOT LAY THE CABLE IN CLOSE PROXIMITY TO THE CONTROL PANEL CABLE! WHILE ROUTING THE CONTROL PANEL CABLE DO NOT COIL THE EXTRA LENGTH.

The KV1 TwinFresh Easy control panel is positioned based on the general project draft of the TwinFresh Easy ventilator control system for a specific facility.

Caution! The control panel must be reliably secured in the working position on a smooth surface.

The design and structure of the TwinFresh Easy ventilator control system is outlined in the ST1 TwinFresh Easy controller's user manual.

The control panel is connected to the CT1 TwinFresh Easy controller by means of a **J-Y(St)Y 2x2x0.8** signal wire.

The wiring length of the line connecting the KV1 TwinFresh Easy panel to the CT1 TwinFresh Easy controller must not exceed 100 m.

Mounting sequence

1. Prepare a niche in the wall for the mounting box.

Route the wire to the site where the control panel is secured. Fixed wiring must be routed in the building's walls.

Install the mounting box.

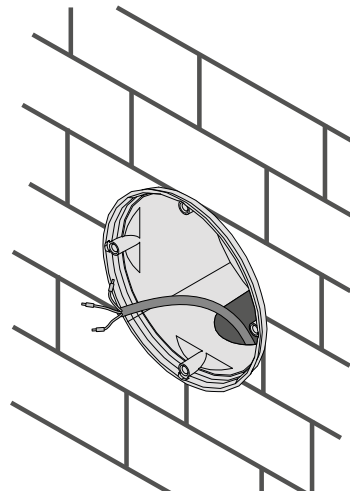

2. Use a screwdriver to detach the panel casing's parts by carefully pressing the latch on the side of the casing.

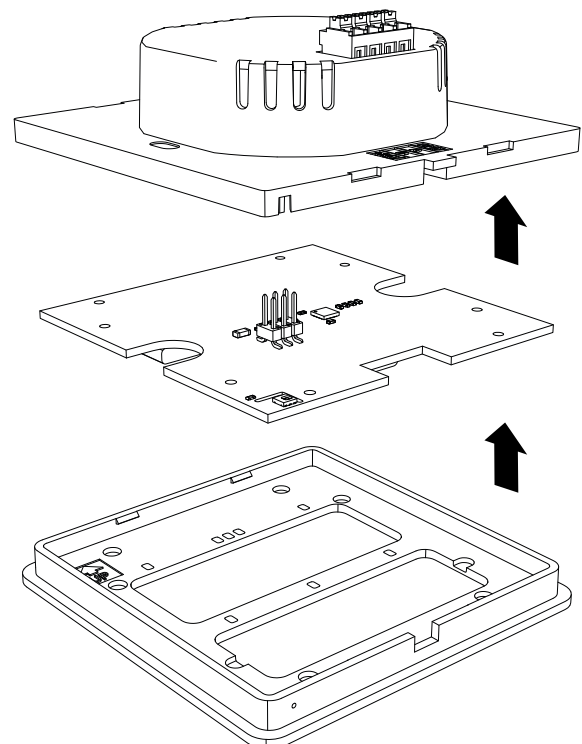
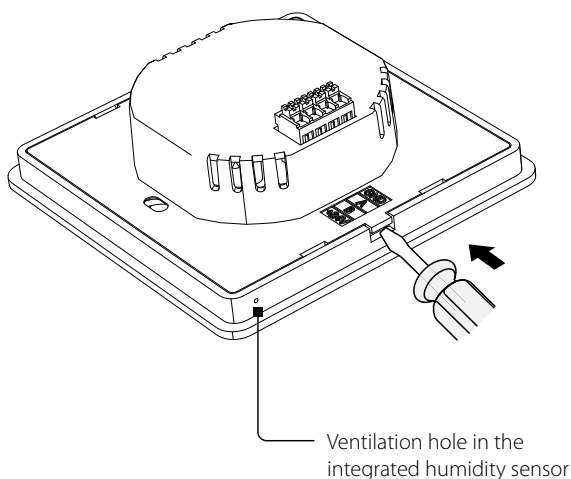

3. Connect the cable to the terminal on the back side of the casing following the label on the panel casing.

Use the holes to attach the casing to the mounting box by means of screws. The screws that connect the control panel to the mounting box are included in the delivery set.

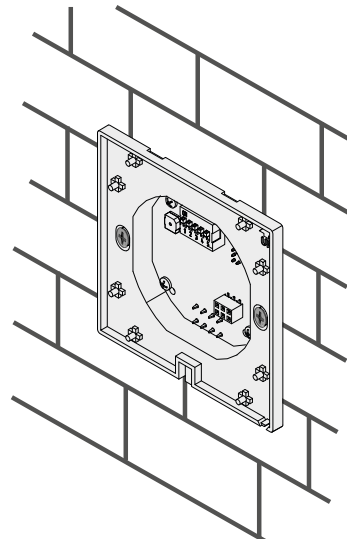

4. Set up the control panel using DIP switches (see description in the "Control" section).

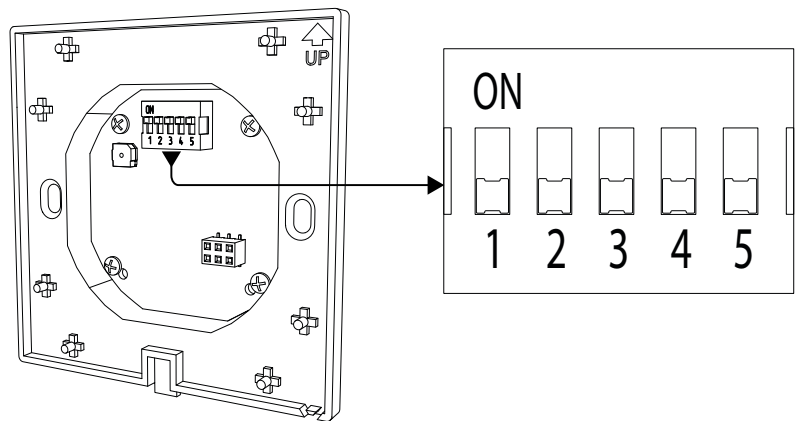

5. Fix the display on the casing by pressing on it and latching it.

Caution! Each time the control panel is turned on, the buttons on the panel's touchscreen are set up automatically.

Turn on the control system after installing the display on the panel's casing only.

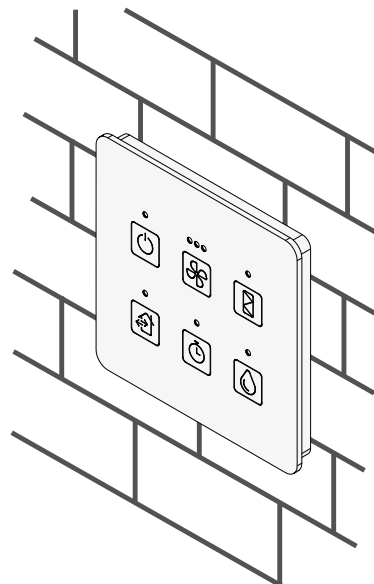

CONTROL

Setting up the control panel via a DIP switch

Switches 1, 2 are used to select the control zone



Control zone 1



Control zone 2

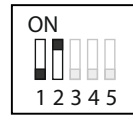

Control zone 3



Control zone 4

Switches 3, 4 are used to select the trigger threshold of the integrated humidity sensor



40 %



50 %



60 %



70 %

Switch 5 is used to enable the termination resistor



The termination resistor is ON*

*Turn on the termination resistor if the control panel is connected first or last in the RS-485 bus.

Ventilator group control

Caution! Do not tap buttons if the panel is not secured to avoid false positives!

Switch speeds by distinctly tapping the necessary control panel area.

Parameters that can be set via the control panel:

- ventilator speed of the system **I, II, III**;
- ventilator operation mode of the system: **Regeneration** or **Ventilation**;
- timer-based operation of ventilators of the system: 8 hours at speed **I**.
in this mode, the ventilators are not activated by triggered sensors;
- enabling / disabling the integrated humidity sensor.





Parameters displayed on the control panel:



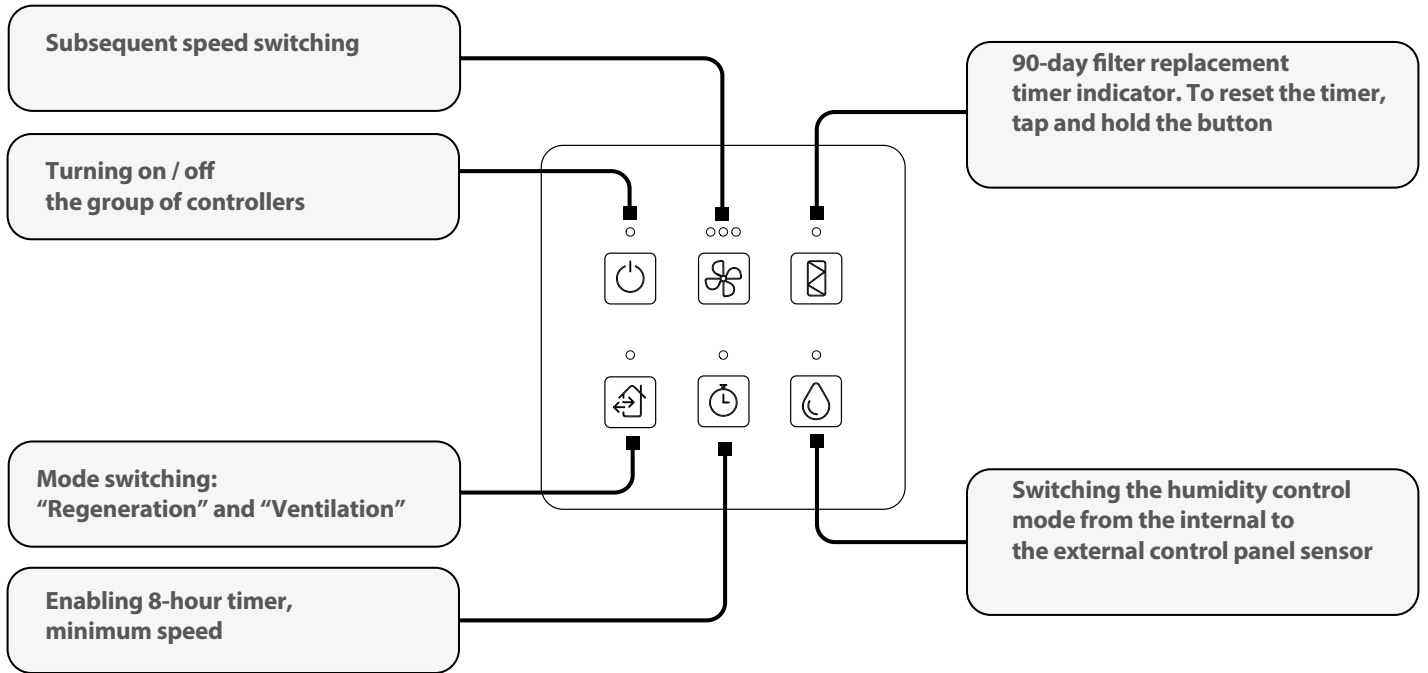

- current speed of the ventilators in the system;
- current operation mode of the ventilators in the system;
- current timer status (On / Off);
- timer-based filter replacement / maintenance status (90 days).

If there is no power supply, the preset parameters are saved in non-volatile random-access memory of the control panel.

The description of functions of buttons on the control panel



Turning on / off the ventilator system	Tap the  button. If the indicator is lit, the ventilation system is ON.
Selecting the unit speed	The speed selection sequence is as follows: I-II-III by tapping the  button. The number of lit indicators indicates the current speed.
Filter maintenance	The indicator  is lit after the filter timer expires: the filter requires cleaning or replacing. The filter replacement timer must be reset after maintenance. To reset the the timer, tap and hold the button for 5 seconds until the beeping sound is heard. After all buttons have flashed twice, release the filter maintenance button.
Selecting the unit operation mode	The ventilator system is switched from Ventilation mode to Regeneration mode by tapping the  button. If the indicator is lit, the system is operating in the Regeneration mode.

<p>Enabling / disabling the integrated humidity sensor</p>	<p>When the integrated humidity sensor is activated with the button , the ventilation system starts operating so that when the sensor is triggered, all the ventilators switch to maximum speed in the Ventilation mode. If the indicator is lit, the integrated sensor is active. Setting the trigger threshold for the integrated humidity sensor as described in the Control section.</p> <p>If the humidity sensor is disabled, tap the  button again.</p>
<p>Timer ON</p>	<p>Upon tapping , an 8-hour timer is set. When the timer countdown is on, the ventilation system is operating in the Ventilation mode at minimum speed and does not respond to triggered sensors. When the timer expires, the settings are reset as before the timer was turned on.</p> <p>For mandatory shutdown of the active timer, tap the  button. After that the ventilation system resets to the previous settings.</p>

STORAGE AND TRANSPORTATION REGULATIONS

- Store the unit in the manufacturer's original packaging box in a dry closed ventilated premise with temperature range from +5 °C to + 40 °C and relative humidity up to 70 %.
- Storage environment must not contain aggressive vapors and chemical mixtures provoking corrosion, insulation, and sealing deformation.
- Use suitable hoist machinery for handling and storage operations to prevent possible damage to the unit.
- Follow the handling requirements applicable for the particular type of cargo.
- The unit can be carried in the original packaging by any mode of transport provided proper protection against precipitation and mechanical damage. The unit must be transported only in the working position.
- Avoid sharp blows, scratches, or rough handling during loading and unloading.
- Prior to the initial power-up after transportation at low temperatures, allow the unit to warm up at operating temperature for at least 3-4 hours.

MANUFACTURER'S WARRANTY

The product is in compliance with EU norms and standards on low voltage guidelines and electromagnetic compatibility. We hereby declare that the product complies with the provisions of Electromagnetic Compatibility (EMC) Directive 2014/30/EU of the European Parliament and of the Council, Low Voltage Directive (LVD) 2014/35/EU of the European Parliament and of the Council and CE-marking Council Directive 93/68/EEC. This certificate is issued following test carried out on samples of the product referred to above.

The manufacturer hereby warrants normal operation of the unit for 24 months after the retail sale date provided the user's observance of the transportation, storage, installation, and operation regulations. Should any malfunctions occur in the course of the unit operation through the Manufacturer's fault during the guaranteed period of operation, the user is entitled to get all the faults eliminated by the manufacturer by means of warranty repair at the factory free of charge. The warranty repair includes work specific to elimination of faults in the unit operation to ensure its intended use by the user within the guaranteed period of operation. The faults are eliminated by means of replacement or repair of the unit components or a specific part of such unit component.

The warranty repair does not include:

- routine technical maintenance
- unit installation/dismantling
- unit setup

To benefit from warranty repair, the user must provide the unit, the user's manual with the purchase date stamp, and the payment paperwork certifying the purchase. The unit model must comply with the one stated in the user's manual. Contact the Seller for warranty service.

The manufacturer's warranty does not apply to the following cases:

- User's failure to submit the unit with the entire delivery package as stated in the user's manual including submission with missing component parts previously dismantled by the user.
- Mismatch of the unit model and the brand name with the information stated on the unit packaging and in the user's manual.
- User's failure to ensure timely technical maintenance of the unit.
- External damage to the unit casing (excluding external modifications as required for installation) and internal components caused by the user.
- Redesign or engineering changes to the unit.
- Replacement and use of any assemblies, parts and components not approved by the manufacturer.
- Unit misuse.
- Violation of the unit installation regulations by the user.
- Violation of the unit control regulations by the user.
- Unit connection to power mains with a voltage different from the one stated in the user's manual.
- Unit breakdown due to voltage surges in power mains.
- Discretionary repair of the unit by the user.
- Unit repair by any persons without the manufacturer's authorization.
- Expiration of the unit warranty period.
- Violation of the unit transportation regulations by the user.
- Violation of the unit storage regulations by the user.
- Wrongful actions against the unit committed by third parties.
- Unit breakdown due to circumstances of insuperable force (fire, flood, earthquake, war, hostilities of any kind, blockades).
- Missing seals if provided by the user's manual.
- Failure to submit the user's manual with the unit purchase date stamp.
- Missing payment paperwork certifying the unit purchase.



FOLLOWING THE REGULATIONS STIPULATED HEREIN WILL ENSURE A LONG AND TROUBLE-FREE OPERATION OF THE UNIT



USER'S WARRANTY CLAIMS SHALL BE SUBJECT TO REVIEW ONLY UPON PRESENTATION OF THE UNIT, THE PAYMENT DOCUMENT AND THE USER'S MANUAL WITH THE PURCHASE DATE STAMP

CERTIFICATE OF ACCEPTANCE

Unit Type	Control panel
Model	
Serial Number	
Manufacture Date	
Quality Inspector's Stamp	

SELLER INFORMATION

Seller	
Address	
Phone Number	
E-mail	
Purchase Date	
This is to certify acceptance of the complete unit delivery with the user's manual. The warranty terms are acknowledged and accepted.	
Customer's Signature	

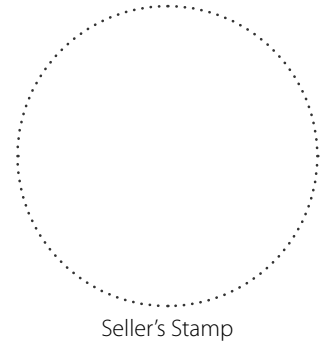

INSTALLATION CERTIFICATE

The _____ unit is installed pursuant to the requirements stated in the present user's manual.	
Company name	
Address	
Phone Number	
Installation Technician's Full Name	
Installation Date:	Signature:
The unit has been installed in accordance with the provisions of all the applicable local and national construction, electrical and technical codes and standards. The unit operates normally as intended by the manufacturer.	
Signature:	

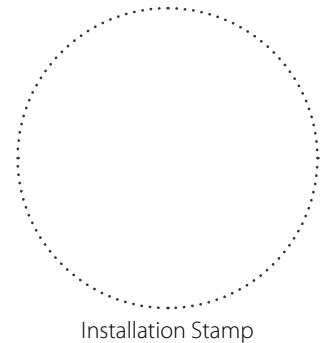

WARRANTY CARD

Unit Type	Control panel
Model	
Serial Number	
Manufacture Date	
Purchase Date	
Warranty Period	
Seller	

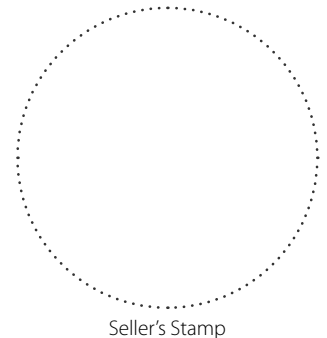



VENTS

