

Series
VENTS VCN



Exhaust centrifugal fans in steel casing with the air capacity up to **710 m³/h** for outdoor surface mounting

■ **Applications**

Exhaust ventilation systems for commercial, office and other public or industrial premises for extraction of air with temperatures up to 55 °C. Direct air exhaust is provided.

■ **Design**

Steel casing with polymeric coating ensures motor protection against direct humidity exposure in case of the unit outdoor mounting. The fan bottom has a bird and rodent proof guard. Air is exhausted vertically down.

■ **Motor**

The centrifugal impeller with backward curved blades is powered by the single phase motor with external rotor and overheating protection with automatic restart. The motor is equipped with ball bearings for long service life designed for at least 40 000 hours. For precise features, safe operation and low noise, each turbine is dynamically balanced while assembly. Motor protection rating IP44.

■ **Speed control**

Smooth or step speed control with a thyristor or autotransformer speed controller. Several fans may be connected to one speed controller provided that the total power and operating current do not exceed the rated speed controller parameters.

■ **Mounting**

The fan is designed for outdoor surface wall mounting and connection to round duct of the respective diameter. The fan is powered through the external terminals. Electric connection and mounting shall be performed in compliance with the manual and wiring diagram provided in unit operation manual.



The motor is protected against direct water drops and solid objects



VCN fan WC ventilation example

Designation key

Series
VENTS VCN

Air duct diameter
100; 125; 150; 160; 200

Accessories



Silencer

Backdraft damper

Air shutter

Clamps

Speed controllers

Sensor

Technical data

	VCN 100 VCN 100 K		VCN 125 VCN 125 K		VCN 150 VCN 150 K		VCN 160 VCN 160 K		VCN 200 VCN 200 K	
Voltage, [V]	1~230		1~230		1~230		1~230		1~230	
Frequency [Hz]	50	60	50	60	50	60	50	60	50	60
Power [W]	71	92	75	98	96	100	95	96	96	97
Current [A]	0.31	0.4	0.33	0.43	0.42	0.44	0.41	0.42	0.42	0.42
Max. air flow [m ³ /h]	325 (295*)	350 (320*)	485 (450*)	500 (465*)	630 (565*)	650 (595*)	650 (590*)	685 (625*)	700 (640*)	710 (650*)
RPM [min ⁻¹]	2530	2625	2475	2570	2400	2270	2440	2400	2515	2555
Noise level at 3 m [dBA]	54	54	54	54	58	58	60	60	62	62
Transported air temperature [°C]	55	55	55	55	55	55	55	55	55	55
SEC class	C		B		B		B		B	
Protection rating	IPX4		IPX4		IPX4		IPX4		IPX4	

* - for the models with an integrated backdraft damper (VCN ... K)

Fan overall dimensions

Type	Dimensions [mm]				Mass [kg]
	∅D	B	H	L	
VCN 100	99	260	355	138	3.82
VCN 125	124	260	355	138	3.82
VCN 150	149	300	400	138,2	4.53
VCN 160	159	300	400	138,2	4.53
VCN 200	199	300	400	138,2	4.62

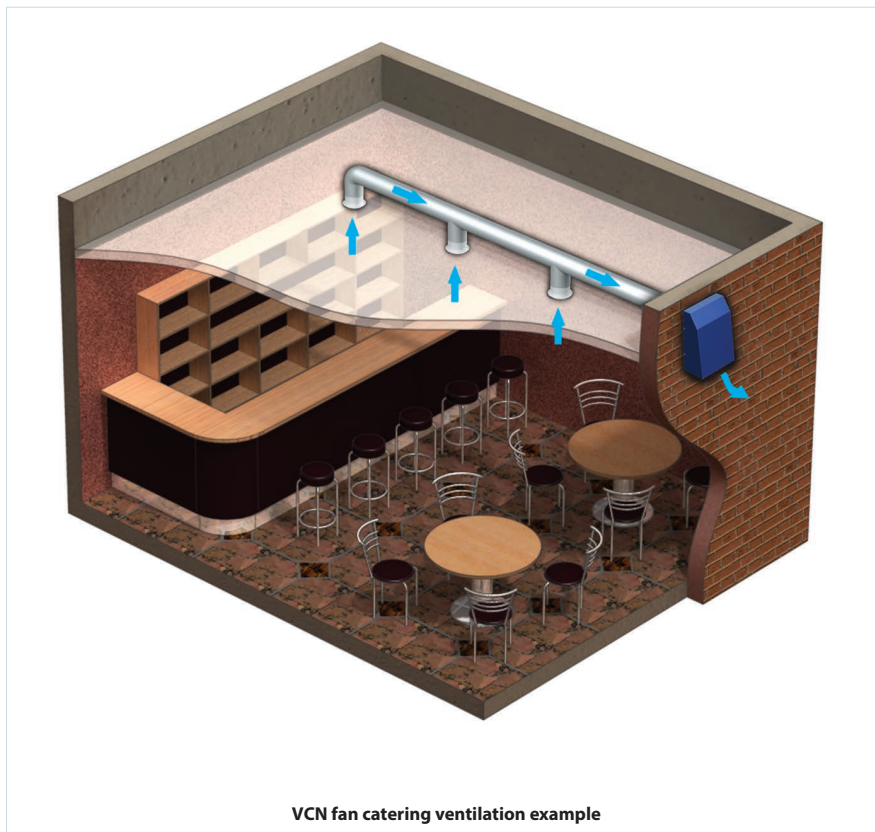
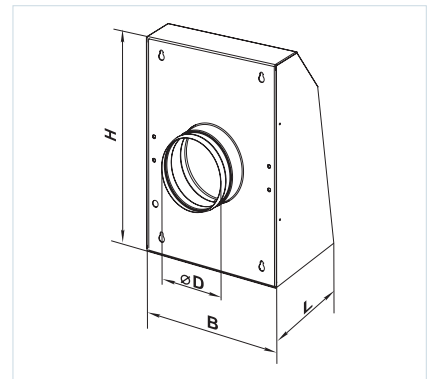

VENTS VCN

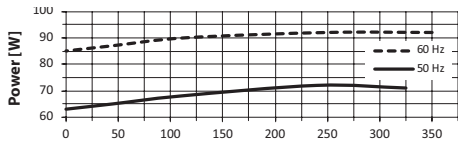
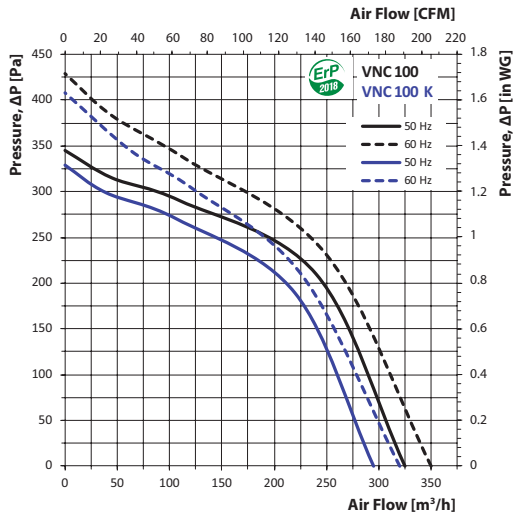

Sound-power level	Hz	Octave-frequency band [Hz]								
		Gen	63	125	250	500	1000	2000	4000	8000
L_{WA} to inlet	dB(A)	60	46	52	58	58	58	51	40	28
L_{WA} to environment	dB(A)	58	39	40	49	55	60	56	43	35

VENTS VCN

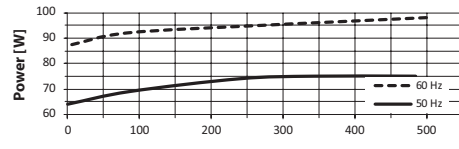
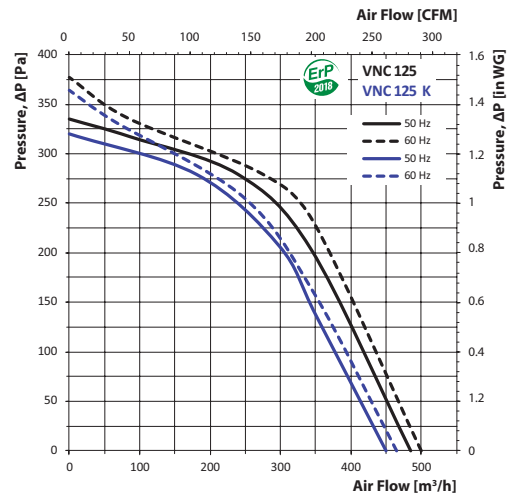

Sound-power level	Hz	Octave-frequency band [Hz]								
		Gen	63	125	250	500	1000	2000	4000	8000
L_{WA} to inlet	dB(A)	58	48	54	59	56	57	52	42	29
L_{WA} to environment	dB(A)	59	41	41	52	55	58	54	46	35

VENTS VCN

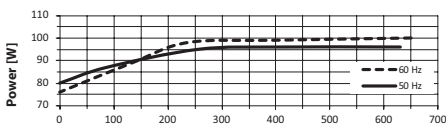
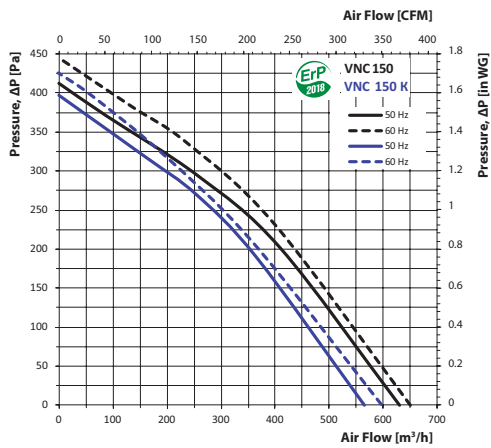

Sound-power level	Hz	Octave-frequency band [Hz]								
		Gen	63	125	250	500	1000	2000	4000	8000
L_{WA} to inlet	dB(A)	57	45	53	54	57	56	46	38	19
L_{WA} to environment	dB(A)	56	48	38	48	52	54	49	39	32

VENTS VCN

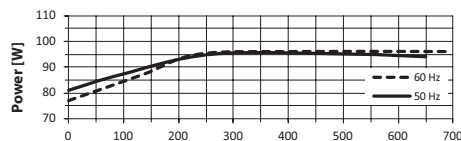
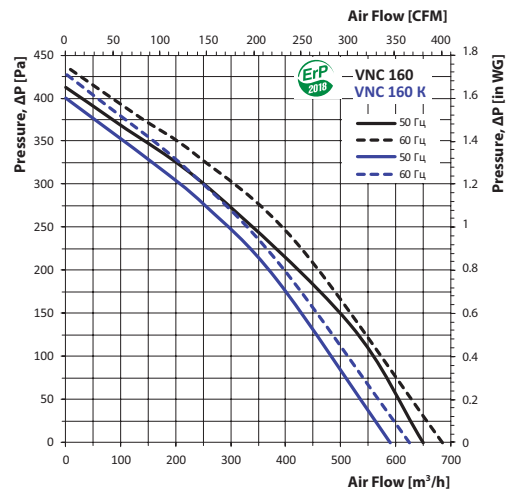

Sound-power level	Hz	Octave-frequency band [Hz]								
		Gen	63	125	250	500	1000	2000	4000	8000
L_{WA} to inlet	dB(A)	55	44	54	55	58	54	46	36	18
L_{WA} to environment	dB(A)	54	46	39	49	51	53	49	42	31

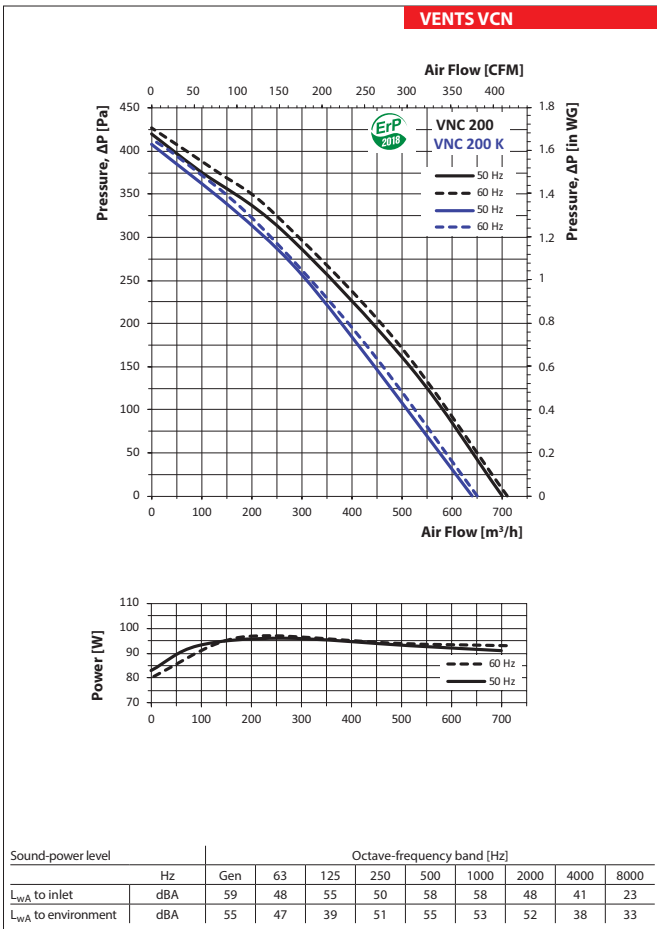

FAN SERIES VENTS VCN