

Series
VKPD

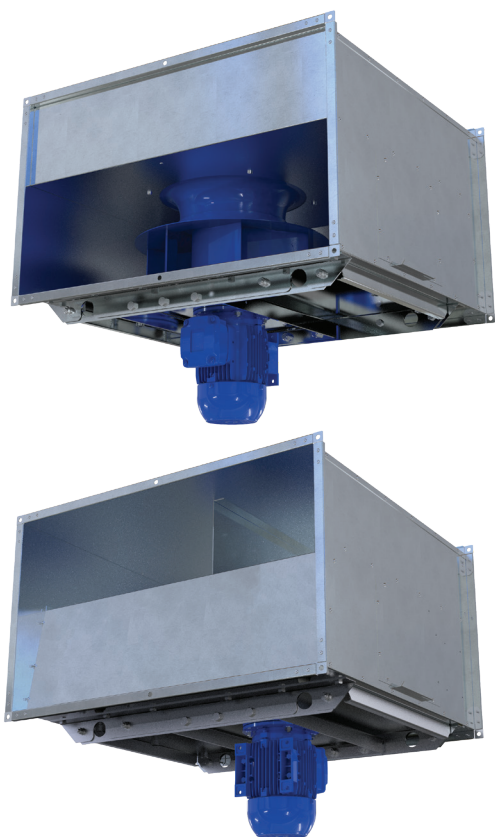

Duct smoke extraction fan.
Air flow – up to 28 500 m³/h

■ **Application**

The dual-purpose fan is used in emergency exhaust ventilation systems for forced removal of smoke, heated gases and combustion products, as well as for general exhaust ventilation of shopping centres, garages, warehouses, kitchens.

■ **Operation**

The fan is designed to remove smoke and air mixtures up to +400 °C for 120 minutes and for continuous operation at a temperature of the transported medium up to +100 °C. The fans can be equipped with a frequency converter for controlling the rotation frequency.

■ **Design**

The fan casing is made of galvanized steel.
The impeller with backward curved blades made of heat-resisting steel.

■ **Motor**

The fans can be equipped with a single- or three-phase electric motor with power from 0.37 to 7.5 kW, degree of protection IP54 and designed for connection to 230/400 V, 50 Hz power mains.
Single-speed fans are equipped with 2- or 4-pole motors.
Two-speed fans are equipped with 2/4, 4/6, 4/8-pole motors.
The electric motor is installed outside the air flow.

Designation key

VENTS VKPD-250-2E/0,37-500x300

				Spigot dimension [mm]	
				500x300; 600x300; 600x350; 700x400; 700x500; 800x600; 900x700; 1000x800; 1200x900	
			Motor power [kW]		
			x – single-speed; x/x – two-speed		
		Number of phases			
		E – single-phase; D – three-phase			
		Number of poles			
		2 – if it is a single-speed fan			
		4 – if it is a single-speed fan			
		6 – if it is a single-speed fan			
		2/4 – if it is a two-speed fan			
		4/6 – if it is a two-speed fan			
		Impeller standard size [mm]			
		250; 280; 315; 355; 400; 450; 500; 560; 630; 710			
VKPD – rectangular duct fan for smoke removal					

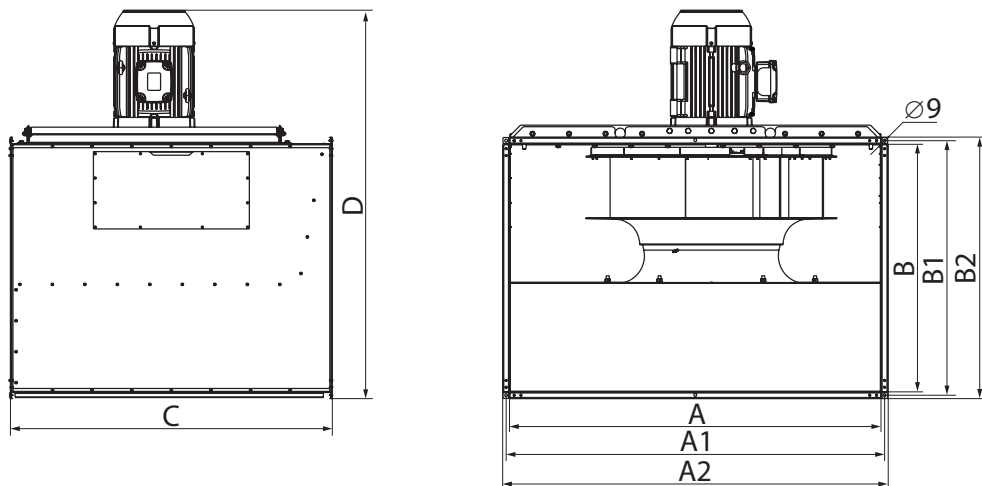

■ Overall dimensions [mm]

Model	Dimensions [mm]								Weight [kg]
	A	A1	A2	B	B1	B2	C	D	
VKPD-250	500	520	540	300	320	340	680	557	40
VKPD-280	600	620	640	300	320	340	680	558	40
VKPD-315	600	620	640	350	370	390	680	624	56
VKPD-355	700	720	740	400	420	440	680	657	51
VKPD-400	700	720	740	500	520	540	680	772	70
VKPD-450	800	820	840	600	620	640	800	872	89
VKPD-500	800	820	840	600	620	640	840	914	97
VKPD-560	900	920	940	700	720	740	840	1058	100
VKPD-630	1000	1020	1040	800	820	840	1040	1150	130
VKPD-710	1200	1220	1245	900	920	945	1040	1354	178

DUCT SMOKE EXTRACTION FANS

Technical data

Standard size	Number of poles	Voltage [V]	Fan model	Rated power Ny [kW]	RPM [min ⁻¹]	High speed chart number	Low speed chart number
250	2	1~230	VKPD-250-2E/0,37-500x300	0,37	2880	①	-
	2	3~400	VKPD-250-2D/0,37-500x300	0,37	2880	①	-
	2/4	3~400	VKPD-250-2/4D/0,37/0,1-500x300	0,37/0,1	2880/1440	①	②
280	2	1~230	VKPD-280-2E/0,55-600x300	0,55	2880	③	-
	2	3~400	VKPD-280-2D/0,55-600x300	0,55	2880	③	-
	2/4	3~400	VKPD-280-2/4D/0,55/0,11-600x300	0,55/0,11	2880/1440	③	④
315	2	1~230	VKPD-315-2E/1,1-600x350	1,1	2880	⑤	-
	2	3~400	VKPD-315-2D/1,1-600x350	1,1	2880	⑤	-
	2/4	3~400	VKPD-315-2/4D/1,1/0,25-600x350	1,1/0,25	2880/1440	⑤	⑥
355	4	1~230	VKPD-355-4E/0,37-700x400	0,37	1420	⑦	-
	4	3~400	VKPD-355-4D/0,37-700x400	0,37	1420	⑦	-
	4/6	3~400	VKPD-355-4/6D/0,37/0,11-700x400	0,37/0,11	1420/905	⑦	⑧

Standard size: 250

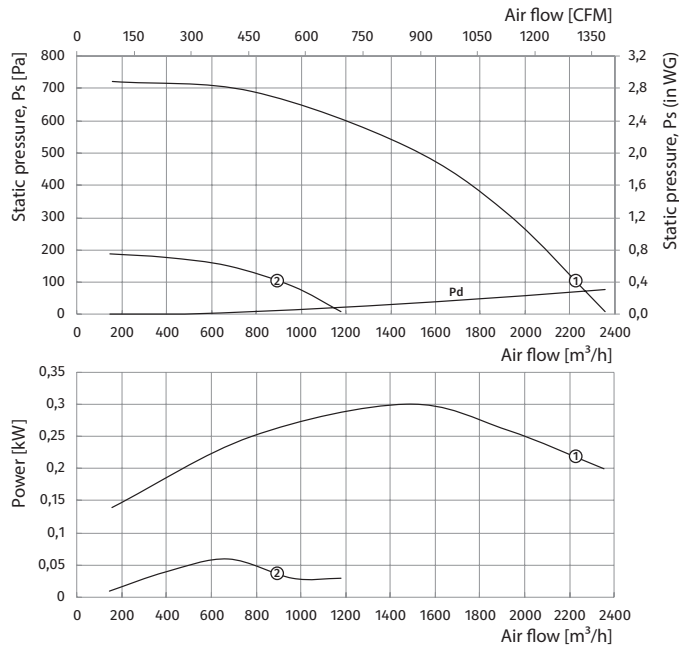

Standard size: 280

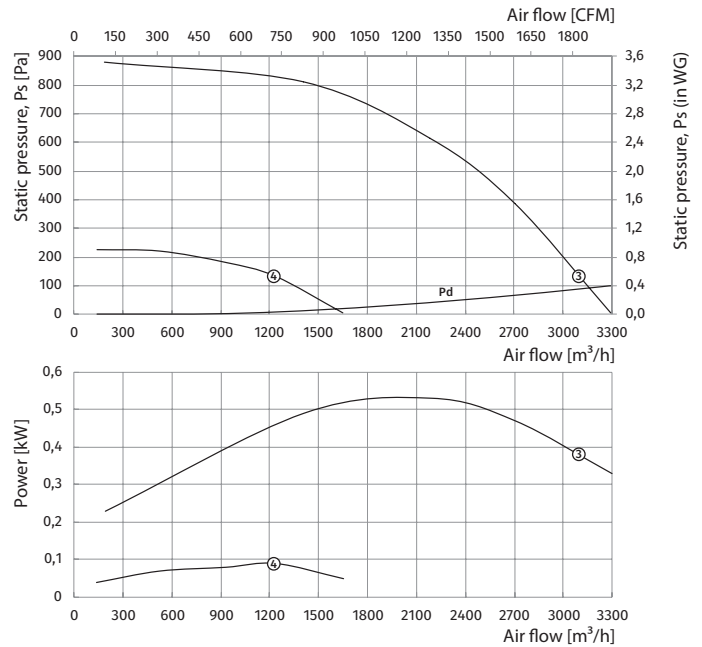

Standard size: 315

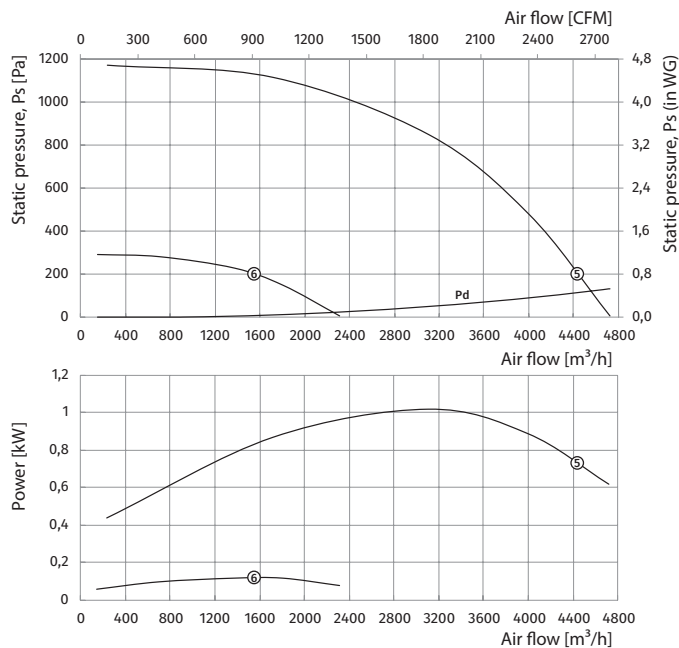

Standard size: 355

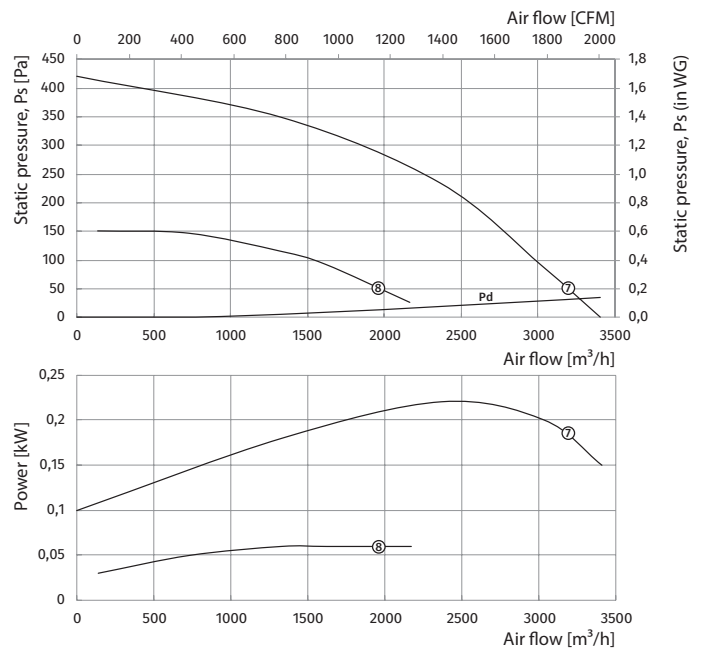

Technical data

Standard size	Number of poles	Voltage [V]	Fan model	Rated power Ny [kW]	RPM [min ⁻¹]	High speed chart number	Low speed chart number
400	4	1~230	VKPD-400-4E/0,55-700x500	0,55	1420	①	-
	4	3~400	VKPD-400-4D/0,55-700x500	0,55	1420	①	-
	4/6	3~400	VKPD-400-4/6D/0,55/0,2-700x500	0,55/0,2	1420/905	①	②
450	4	1~230	VKPD-450-4E/0,75-800x600	0,75	1435	③	-
	4	3~400	VKPD-450-4D/0,75-800x600	0,75	1435	③	-
	4/6	3~400	VKPD-450-4/6D/0,75/0,25-800x600	0,75/0,25	1435/905	③	④
500	4	1~230	VKPD-500-4E/1,5-800x600	1,5	1430	⑤	-
	4	3~400	VKPD-500-4D/1,5-800x600	1,5	1430	⑤	-
	4/6	3~400	VKPD-500-4/6D/1,5/0,37-800x600	1,5/0,37	1430/920	⑤	⑥
560	4	1~230	VKPD-560-4E/3-900x700	3	1435	⑦	-
	4	3~400	VKPD-560-4D/3-900x700	3	1435	⑦	-
	4/6	3~400	VKPD-560-4/6D/3,0/1,0-900x700	3,0/1,0	1435/950	⑦	⑧
	4/8	3~400	VKPD-560-4/8D/2,8/0,7-900x700	2,8/0,7	1435/710	⑦	⑨

Standard size: 400

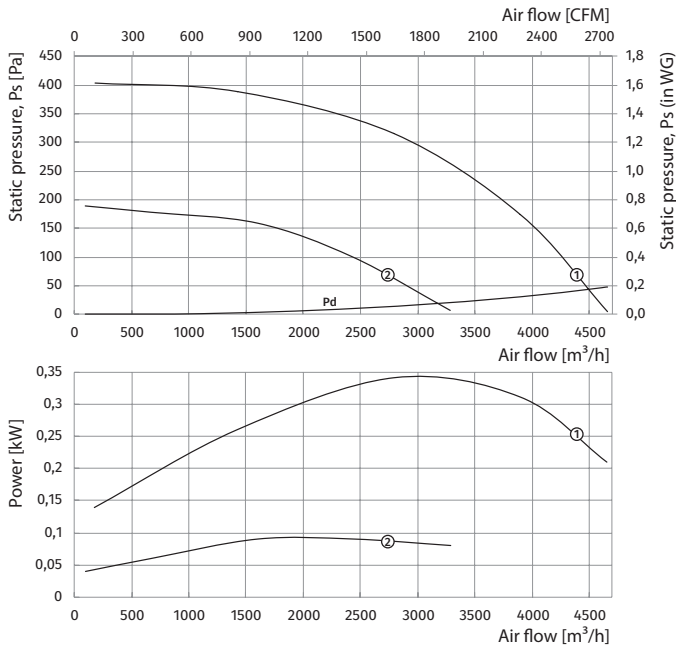

Standard size: 450

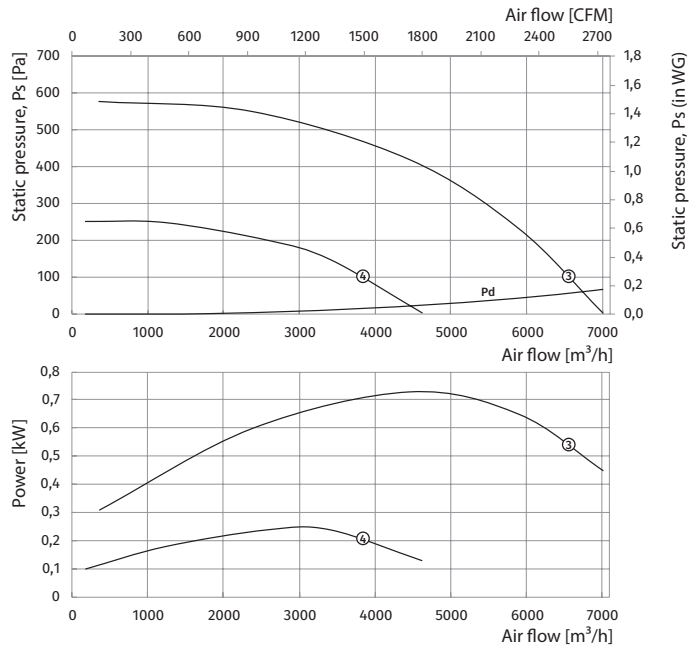

Standard size: 500

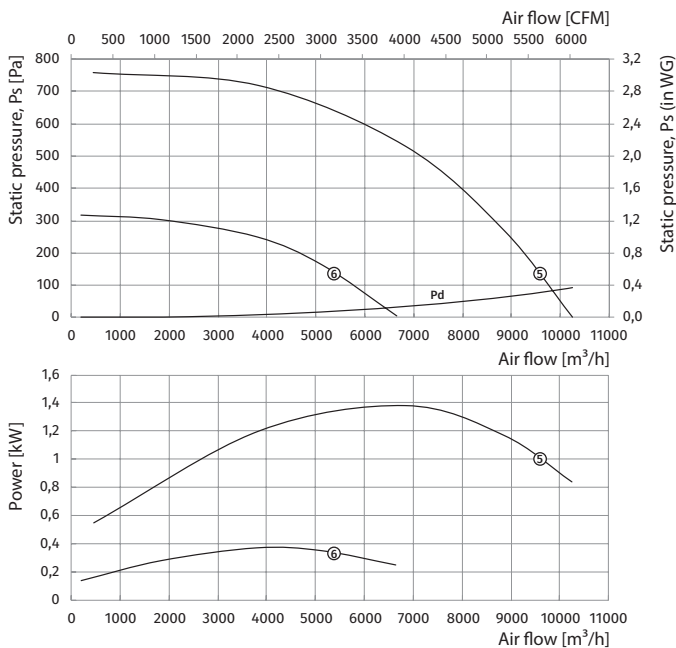

Standard size: 560

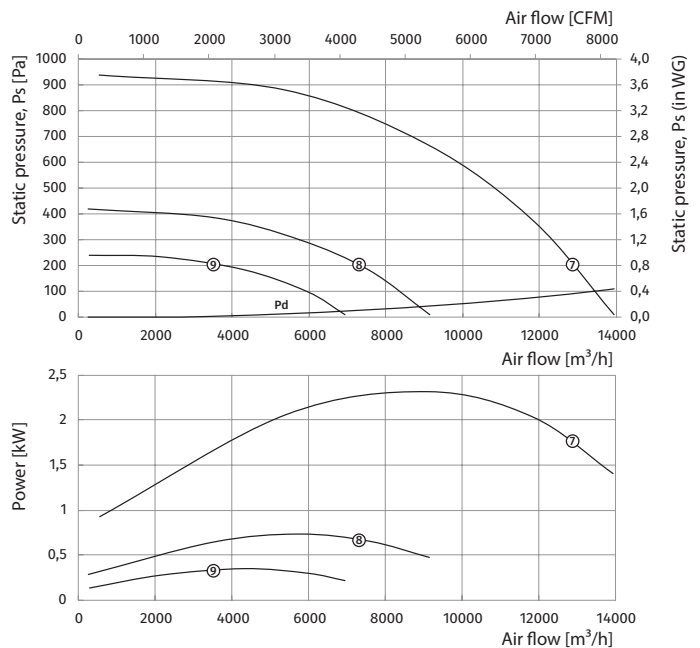

DUCT SMOKE EXTRACTION FANS

Technical data

Standard size	Number of poles	Voltage [V]	Fan model	Rated power Ny [kW]	RPM [min ⁻¹]	High speed chart number	Low speed chart number
630	4	3~400	VKPD-630-4D/4-1000x800	4	1445	①	-
	4/6	3~400	VKPD-630-4/6D/4,5/1,5-1000x800	4,5/1,5	1445/950	①	②
	4/8	3~400	VKPD-630-4/8D/3,8/1,0-1000x800	3,8/1,0	1445/720	①	③
710	4	3~400	VKPD-710-4D/7,5-1200x900	7,5	1455	④	-
	4/6	3~400	VKPD-710-4/6D/4,5/1,5-1200x900	4,5/1,5	1455/960	④	⑤
	4/8	3~400	VKPD-710-4/8D/7,5/1-1200x900	7,2/1,8	1455/720	④	⑥

Standard size: 630

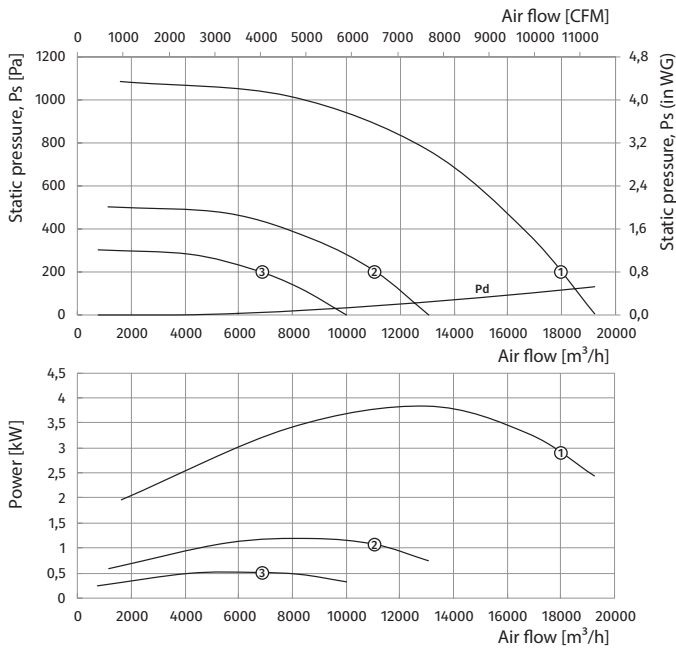

Standard size: 710

