

# 100 Base TH



Vents Base - domestic axial extract fan by Design Concept system, designed for rooms with normal or increased humidity: kitchen, bathroom and shower rooms etc.

- Maximum airflow: 100
- Sound pressure level LpA at 3 m: 34
- Motor type: AC
- Impeller type: Axial
- Casing material: Plastic
- Humidity sensor
- Timer: Turn off timer

	Unit of measurement	100 Base TH
Connected air duct size	mm	100
Speed	-	1
Minimum supply voltage	V	220
Maximum supply voltage	V	240
Power supply frequency	Hz	50/60
Rated power	W	14
Unit current	A	0.09
Maximum airflow	m <sup>3</sup> /h	100
rotation speed at 50hz	-	2300
Sound pressure level LpA at 3 m	dB(A)	34
Ambient air temperature min	°C	1
Ambient air temperature max	°C	40
Ingress protection rating	-	IP24

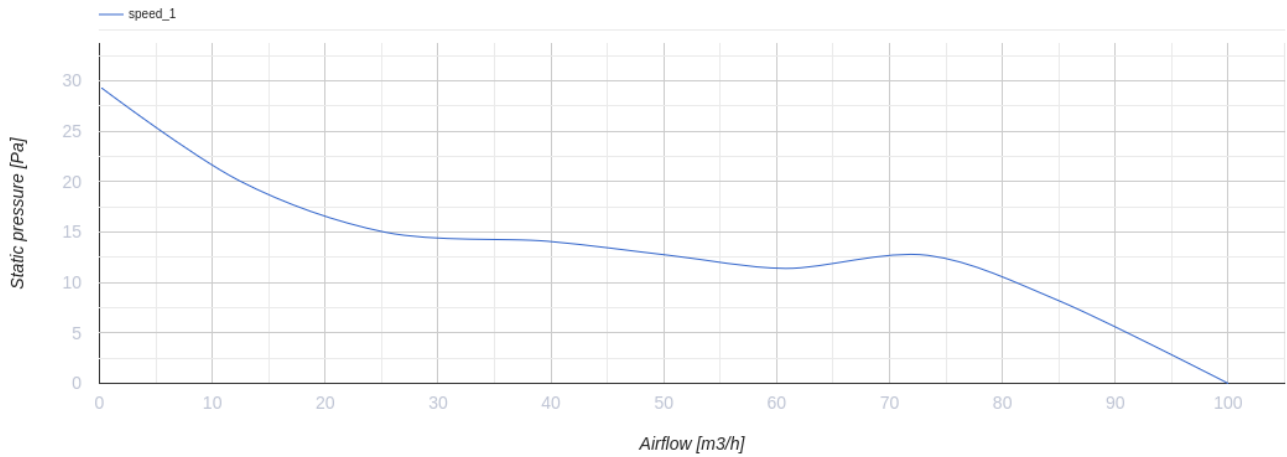

## Dimensions



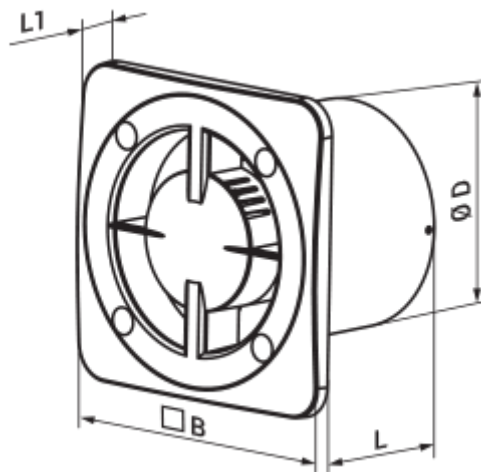











ØD	B	L	L1
99	140	88	13











## Accessories

### Decorative panels

Name	Photo	Description
<a href="#">FP 180 Plain</a>		Removable decorative front panels are a universal solution allowing to choose the design of a fan or ventilation grille for any interior of a bathroom or kitchen.
<a href="#">FP 160 Plain</a>		Removable decorative front panels are a universal solution allowing to choose the design of a fan or ventilation grille for any interior of a bathroom or kitchen.
<a href="#">FP 180 Plain red</a>		Removable decorative front panels are a universal solution allowing to choose the design of a fan or ventilation grille for any interior of a bathroom or kitchen.

<a href="#">FP 160 Plain red</a>		Removable decorative front panels are a universal solution allowing to choose the design of a fan or ventilation grille for any interior of a bathroom or kitchen.
<a href="#">FP 180 Plain black sapphire</a>		Removable decorative front panels are a universal solution allowing to choose the design of a fan or ventilation grille for any interior of a bathroom or kitchen.
<a href="#">FP 160 Plain black sapphire</a>		Removable decorative front panels are a universal solution allowing to choose the design of a fan or ventilation grille for any interior of a bathroom or kitchen.
<a href="#">FP 180 Plain metallic</a>		Removable decorative front panels are a universal solution allowing to choose the design of a fan or ventilation grille for any interior of a bathroom or kitchen.
<a href="#">FP 180 Plain wing</a>		Removable decorative front panels are a universal solution allowing to choose the design of a fan or ventilation grille for any interior of a bathroom or kitchen.
<a href="#">FPB 180/100 Disc</a>		Removable decorative front panels are a universal solution allowing to choose the design of a fan or ventilation grille for any interior of a bathroom or kitchen.
<a href="#">FP 180 Aqua</a>		Removable decorative front panels are a universal solution allowing to choose the design of a fan or ventilation grille for any interior of a bathroom or kitchen.
<a href="#">FP 180 Mars</a>		Removable decorative front panels are a universal solution allowing to choose the design of a fan or ventilation grille for any interior of a bathroom or kitchen.
<a href="#">FP 180 Mystery</a>		Removable decorative front panels are a universal solution allowing to choose the design of a fan or ventilation grille for any interior of a bathroom or kitchen.
<a href="#">FP 160 Reef</a>		Removable decorative front panels are a universal solution allowing to choose the design of a fan or ventilation grille for any interior of a bathroom or kitchen.
<a href="#">FP 160 Frizz</a>		Removable decorative front panels are a universal solution allowing to choose the design of a fan or ventilation grille for any interior of a bathroom or kitchen.
<a href="#">FP 180 Plain chrome</a>		Removable decorative front panels are a universal solution allowing to choose the design of a fan or ventilation grille for any interior of a bathroom or kitchen.
<a href="#">FP 160 Plain chrome</a>		Removable decorative front panels are a universal solution allowing to choose the design of a fan or ventilation grille for any interior of a bathroom or kitchen.
<a href="#">FP 180 Plain alumat</a>		Removable decorative front panels are a universal solution allowing to choose the design of a fan or ventilation grille for any interior of a bathroom or kitchen.
<a href="#">FP 160 Plain alumat</a>		Removable decorative front panels are a universal solution allowing to choose the design of a fan or ventilation grille for any interior of a bathroom or kitchen.

<a href="#">FPB 180/100 Glass-1</a>		Removable decorative front panels are a universal solution allowing to choose the design of a fan or ventilation grille for any interior of a bathroom or kitchen.
<a href="#">FPB 160 Glass-1</a>		Removable decorative front panels are a universal solution allowing to choose the design of a fan or ventilation grille for any interior of a bathroom or kitchen.
<a href="#">FPB 160 Glass-1 red</a>		Removable decorative front panels are a universal solution allowing to choose the design of a fan or ventilation grille for any interior of a bathroom or kitchen.
<a href="#">FPB 180/100 Glass-1 red</a>		Removable decorative front panels are a universal solution allowing to choose the design of a fan or ventilation grille for any interior of a bathroom or kitchen.
<a href="#">FPB 160 Glass-1 black</a>		Removable decorative front panels are a universal solution allowing to choose the design of a fan or ventilation grille for any interior of a bathroom or kitchen.
<a href="#">FPB 180/100 Glass-1 black</a>		Removable decorative front panels are a universal solution allowing to choose the design of a fan or ventilation grille for any interior of a bathroom or kitchen.
<a href="#">FP 180 Plain gold</a>		Removable decorative front panels are a universal solution allowing to choose the design of a fan or ventilation grille for any interior of a bathroom or kitchen.
<a href="#">FP 180 Plain dim</a>		Removable decorative front panels are a universal solution allowing to choose the design of a fan or ventilation grille for any interior of a bathroom or kitchen.

## Flanges

Name	Photo	Description
<a href="#">FO 100</a>		The window flange applicable for all VENTS fans except for VKO, VKO1, iFan, Quiet, MAO, CF

## Ecodesign

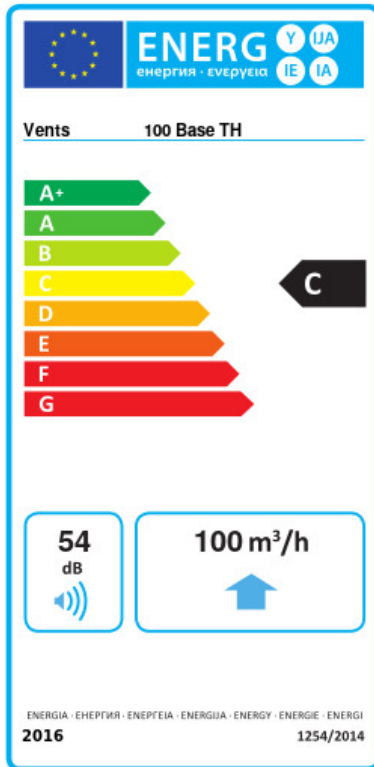

Trademark	Vents					
Model	100 Base TH					
Specific energy consumption (SEC) (kWh/(m <sup>2</sup> /a))	Cold		Average		Warm	
	-52.5	A+	-25.5	C	-9.9	F
Type of ventilation unit	Unidirectional					
Type of drive installed	Single speed					
Type of heat recovery system	None					
Maximum flow rate (m <sup>3</sup> /h)	100					
Electric power input (W)	14					
Reference flow rate (m <sup>3</sup> /s)	0.019					
Specific power input (SPI) (W/(m <sup>3</sup> /h))	0.14					
Control typology	Local demand control					
Maximum external leakage rates (%)	2.7					
Declared typology	RVU UVU					
Sound power level (dB(A))	54					
The annual electricity consumption (AEC) (kWh/a)	Cold		Average		Warm	
	114		114		114	
The annual heating saved (AHS) (kWh/a)	Cold		Average		Warm	
	5536		2830		1280	