

100 PF1 press



Axial fans for exhaust ventilation

- Maximum airflow: 101
- Sound pressure level LpA at 3 m: 38
- Motor type: AC
- Casing material: Plastic

	Unit of measurement	100 PF1 press
Connected air duct size	mm	100
Speed	-	1
Minimum supply voltage	V	220
Maximum supply voltage	V	240
Power supply frequency	Hz	50/60
Rated power	W	16
Unit current	A	0.1
Maximum airflow	m ³ /h	101
Sound pressure level LpA at 3 m	dB(A)	38
Weight	kg	0.47
Ambient air temperature min	°C	1
Ambient air temperature max	°C	40
Ingress protection rating	-	IP34
ErP compliance	-	2016
Cold - Specific energy consumption (SEC)	kWh/(m ² /a)	30
SEC Class Cold	-	B
Average - Specific energy consumption (SEC)	kWh/(m ² /a)	14
SEC Class Average	-	E
Warm - Specific energy consumption (SEC)	kWh/(m ² /a)	5
SEC Class Warm	-	F
Unit category	-	RVU

Type of ventilation unit	-	Unidirectional
Type of drive installed	-	Multi-speed
Type of heat recovery system	-	None
Maximum flow rate	m ³ /h	101
Electric power input	W	16
Reference flow rate	m ³ /s	0.02
Specific power input (SPI)	W/(m ³ /h)	0.102
Control typology	-	Manual control
Maximum external leakage rates	%	2.7
Cold - The annual electricity consumption (AEC)	kWh/a	100
Average - The annual electricity consumption (AEC)	kWh/a	100
Warm - Jährlicher Stromverbrauch (JSV)	kWh/a	100
Cold - The annual heating saved (AHS)	kWh/a	3400
The annual heating saved (AHS) Average	kWh/a	1700
The annual heating saved (AHS) Warm	kWh/a	800
Sound power level	dB(A)	58
Declared typology	-	RVU UVU

Dimensions

Ø D	Ø D1	L	L1
100	141	128	13

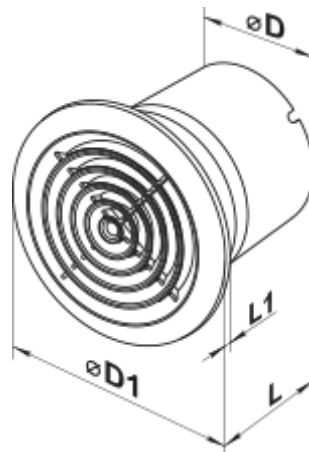

Accessories

Cooker Hoods

Name	Photo	Description
------	-------	-------------

[FO_100](#)



The window flange applicable for all VENTS fans except for VKO, VKO1, iFan, Quiet, MAO, CF