

# 125 Ace TH K L

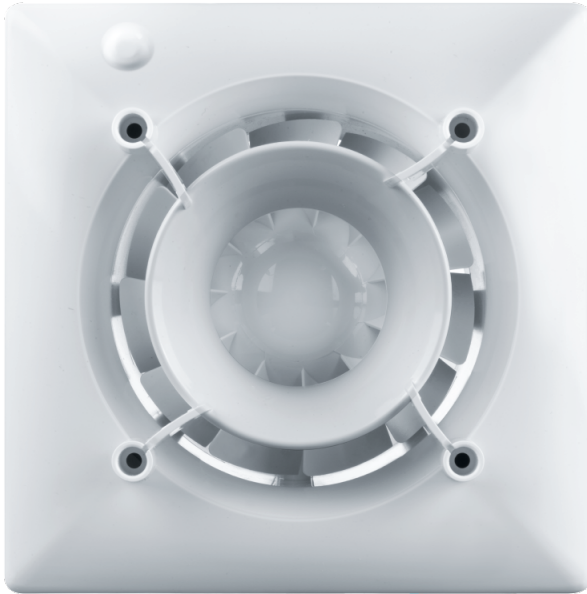

Vents Ace - domestic axial extract fan by Design Concept system with a mixed-type impeller for those who prioritize energy efficiency, high air flow and low noise

- Maximum airflow: 160
- Sound pressure level LpA at 3 m: 32
- Motor type: AC
- Impeller type: Mixed-flow
- Casing material: Plastic
- Backdraft protection: Backdraft damper
- Humidity sensor
- Timer: Turn off timer

	Unit of measurement	125 Ace TH K L
Connected air duct size	mm	125
Speed	-	1
Minimum supply voltage	V	220
Maximum supply voltage	V	240
Power supply frequency	Hz	50
Rated power	W	17
Unit current	A	0.11
Maximum airflow	m <sup>3</sup> /h	160
rotation speed at 50hz	-	2200
Sound pressure level LpA at 3 m	dB(A)	32
Weight	kg	0
Ambient air temperature min	°C	1
Ambient air temperature max	°C	40
Ingress protection rating	-	IP44

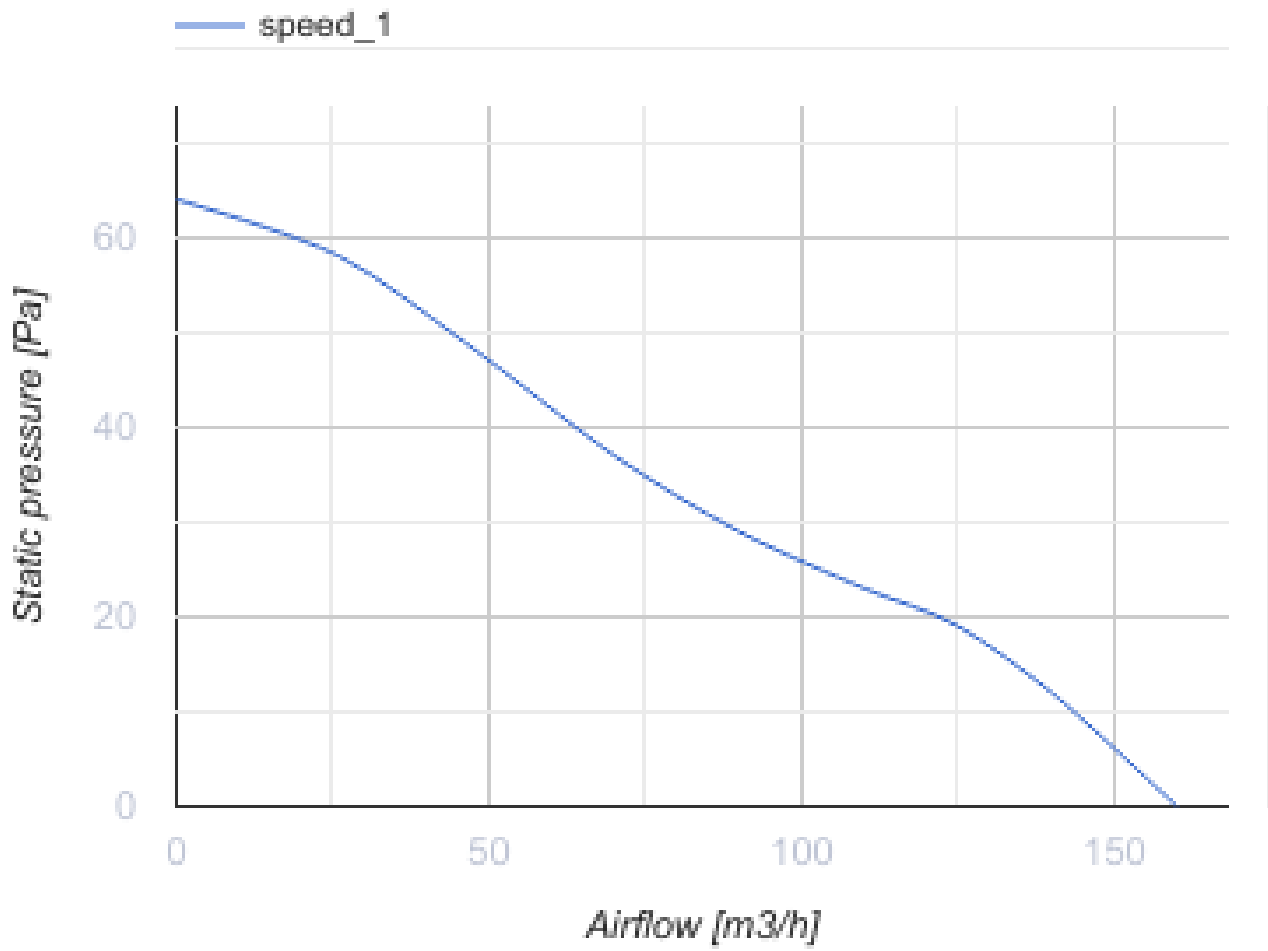





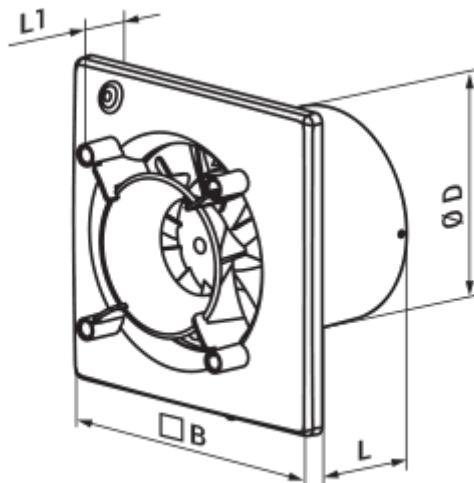



**Dimensions**

ØD	B	L	L1
124	180	85	37



## Accessories

### Decorative panels

Name	Photo	Description
<a href="#">FP 180 Plain</a>		Removable decorative front panels are a universal solution allowing to choose the design of a fan or ventilation grille for any interior of a bathroom or kitchen.
<a href="#">FP 180 Plain red</a>		Removable decorative front panels are a universal solution allowing to choose the design of a fan or ventilation grille for any interior of a bathroom or kitchen.
<a href="#">FP 180 Plain black sapphire</a>		Removable decorative front panels are a universal solution allowing to choose the design of a fan or ventilation grille for any interior of a bathroom or kitchen.
<a href="#">FP 180 Plain metallic</a>		Removable decorative front panels are a universal solution allowing to choose the design of a fan or ventilation grille for any interior of a bathroom or kitchen.
<a href="#">FP 180 Plain wing</a>		Removable decorative front panels are a universal solution allowing to choose the design of a fan or ventilation grille for any interior of a bathroom or kitchen.
<a href="#">FP 180 Aqua</a>		Removable decorative front panels are a universal solution allowing to choose the design of a fan or ventilation grille for any interior of a bathroom or kitchen.
<a href="#">FP 180 Mars</a>		Removable decorative front panels are a universal solution allowing to choose the design of a fan or ventilation grille for any interior of a bathroom or kitchen.
<a href="#">FP 180 Mystery</a>		Removable decorative front panels are a universal solution allowing to choose the design of a fan or ventilation grille for any interior of a bathroom or kitchen.
<a href="#">FP 180 Plain chrome</a>		Removable decorative front panels are a universal solution allowing to choose the design of a fan or ventilation grille for any interior of a bathroom or kitchen.
<a href="#">FP 180 Plain alumat</a>		Removable decorative front panels are a universal solution allowing to choose the design of a fan or ventilation grille for any interior of a bathroom or kitchen.
<a href="#">FPA 180/125 Glass-1</a>		Removable decorative front panels are a universal solution allowing to choose the design of a fan or ventilation grille for any interior of a bathroom or kitchen.
<a href="#">FPA 180/125 Glass-1 red</a>		Removable decorative front panels are a universal solution allowing to choose the design of a fan or ventilation grille for any interior of a bathroom or kitchen.
<a href="#">FPA 180/125 Glass-1 black</a>		Removable decorative front panels are a universal solution allowing to choose the design of a fan or ventilation grille for any interior of a bathroom or kitchen.
<a href="#">FP 180 Plain gold</a>		Removable decorative front panels are a universal solution allowing to choose the design of a fan or ventilation grille for any interior of a bathroom or kitchen.

[FP 180 Plain dim](#)

Removable decorative front panels are a universal solution allowing to choose the design of a fan or ventilation grille for any interior of a bathroom or kitchen.

## Flanges

Name	Photo	Description
<a href="#">FO 125</a>		The window flange applicable for all VENTS fans except for VKO, VKO1, iFan, Quiet, MAO, CF