

## 125 Base L Q



Vents Base - domestic axial extract fan by Design Concept system, designed for rooms with normal or increased humidity: kitchen, bathroom and shower rooms etc.

- Maximum airflow: 147
- Sound pressure level LpA at 3 m: 29
- Motor type: AC
- Impeller type: Axial
- Casing material: Plastic

	Unit of measurement	125 Base L Q
Connected air duct size	mm	125
Speed	-	1
Minimum supply voltage	V	220
Maximum supply voltage	V	240
Power supply frequency	Hz	50/60
Rated power	W	8
Unit current	A	0.053
Maximum airflow	m <sup>3</sup> /h	147
rotation speed at 50hz	-	1600
Sound pressure level LpA at 3 m	dB(A)	29
Ambient air temperature min	°C	1
Ambient air temperature max	°C	40
Ingress protection rating	-	IP24





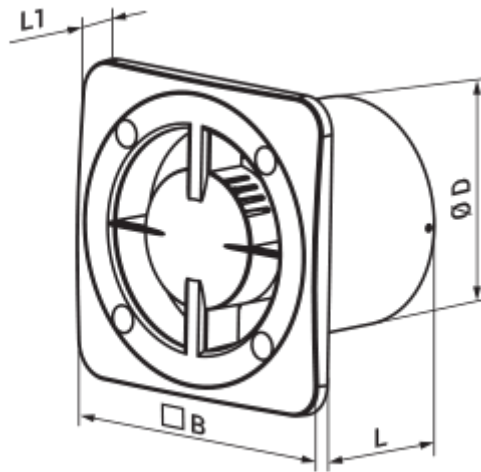



### Dimensions







ØD	B	L	L1
124	165	88	16



## Accessories

### Decorative panels

Name	Photo	Description
<a href="#">FP 180 Plain</a>		Removable decorative front panels are a universal solution allowing to choose the design of a fan or ventilation grille for any interior of a bathroom or kitchen.
<a href="#">FP 180 Plain red</a>		Removable decorative front panels are a universal solution allowing to choose the design of a fan or ventilation grille for any interior of a bathroom or kitchen.
<a href="#">FP 180 Plain black sapphire</a>		Removable decorative front panels are a universal solution allowing to choose the design of a fan or ventilation grille for any interior of a bathroom or kitchen.
<a href="#">FP 180 Plain metallic</a>		Removable decorative front panels are a universal solution allowing to choose the design of a fan or ventilation grille for any interior of a bathroom or kitchen.
<a href="#">FP 180 Plain wing</a>		Removable decorative front panels are a universal solution allowing to choose the design of a fan or ventilation grille for any interior of a bathroom or kitchen.
<a href="#">FPB 180/125 Disc</a>		Removable decorative front panels are a universal solution allowing to choose the design of a fan or ventilation grille for any interior of a bathroom or kitchen.
<a href="#">FP 180 Aqua</a>		Removable decorative front panels are a universal solution allowing to choose the design of a fan or ventilation grille for any interior of a bathroom or kitchen.
<a href="#">FP 180 Mars</a>		Removable decorative front panels are a universal solution allowing to choose the design of a fan or ventilation grille for any interior of a bathroom or kitchen.
<a href="#">FP 180 Mystery</a>		Removable decorative front panels are a universal solution allowing to choose the design of a fan or ventilation grille for any interior of a bathroom or kitchen.

<a href="#">FP 180 Plain chrome</a>		Removable decorative front panels are a universal solution allowing to choose the design of a fan or ventilation grille for any interior of a bathroom or kitchen.
<a href="#">FP 180 Plain alumat</a>		Removable decorative front panels are a universal solution allowing to choose the design of a fan or ventilation grille for any interior of a bathroom or kitchen.
<a href="#">FPB 180/125 Glass-1</a>		Removable decorative front panels are a universal solution allowing to choose the design of a fan or ventilation grille for any interior of a bathroom or kitchen.
<a href="#">FPB 180/125 Glass-1 red</a>		Removable decorative front panels are a universal solution allowing to choose the design of a fan or ventilation grille for any interior of a bathroom or kitchen.
<a href="#">FPB 180/125 Glass-1 black</a>		Removable decorative front panels are a universal solution allowing to choose the design of a fan or ventilation grille for any interior of a bathroom or kitchen.
<a href="#">FP 180 Plain gold</a>		Removable decorative front panels are a universal solution allowing to choose the design of a fan or ventilation grille for any interior of a bathroom or kitchen.
<a href="#">FP 180 Plain dim</a>		Removable decorative front panels are a universal solution allowing to choose the design of a fan or ventilation grille for any interior of a bathroom or kitchen.

### Cooker Hoods

Name	Photo	Description
<a href="#">FO 125</a>		The window flange applicable for all VENTS fans except for VKO, VKO1, iFan, Quiet, MAO, CF