

125 Base turbo



Vents Base - domestic axial extract fan by Design Concept system, designed for rooms with normal or increased humidity: kitchen, bathroom and shower rooms etc.

- Maximum airflow: 217
- Sound pressure level LpA at 3 m: 37
- Motor type: AC
- Impeller type: Axial
- Casing material: Plastic

| | Unit of measurement | 125 Base turbo |
|---------------------------------|---------------------|----------------|
| Connected air duct size | mm | 125 |
| Speed | - | 1 |
| Minimum supply voltage | V | 220 |
| Maximum supply voltage | V | 240 |
| Power supply frequency | Hz | 50/60 |
| Rated power | W | 17 |
| Unit current | A | 0.132 |
| Maximum airflow | m ³ /h | 217 |
| rotation speed at 50hz | - | 2500 |
| Sound pressure level LpA at 3 m | dB(A) | 37 |
| Ambient air temperature min | °C | 1 |
| Ambient air temperature max | °C | 40 |
| Ingress protection rating | - | IP24 |

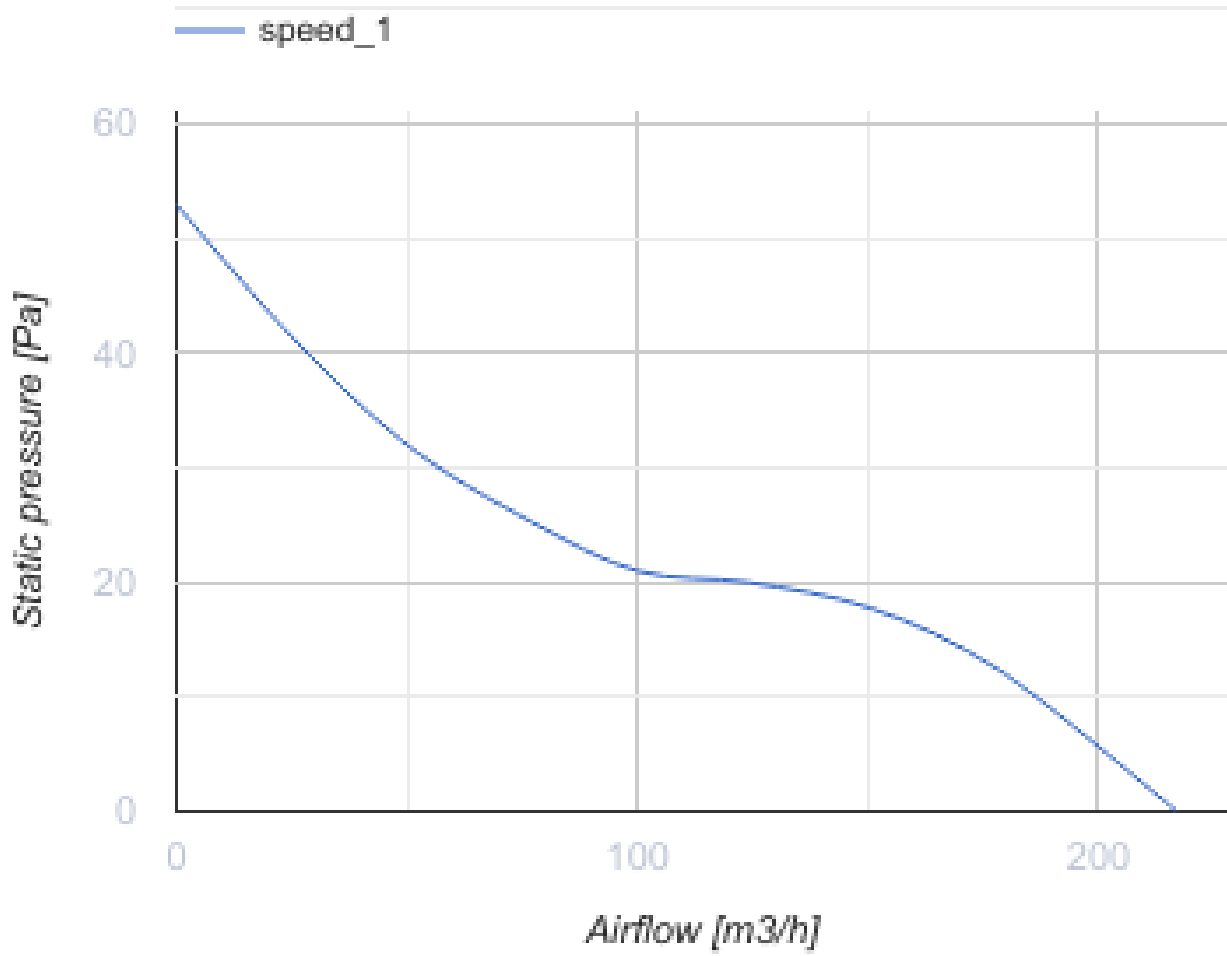















Dimensions



| ØD | B | L | L1 |
|-----|-----|----|----|
| 124 | 165 | 88 | 16 |



Accessories

Decorative panels

| Name | Photo | Description |
|---|---|--|
| FP 180 Plain |  | Removable decorative front panels are a universal solution allowing to choose the design of a fan or ventilation grille for any interior of a bathroom or kitchen. |
| FP 180 Plain red |  | Removable decorative front panels are a universal solution allowing to choose the design of a fan or ventilation grille for any interior of a bathroom or kitchen. |
| FP 180 Plain black sapphire |  | Removable decorative front panels are a universal solution allowing to choose the design of a fan or ventilation grille for any interior of a bathroom or kitchen. |
| FP 180 Plain metallic |  | Removable decorative front panels are a universal solution allowing to choose the design of a fan or ventilation grille for any interior of a bathroom or kitchen. |
| FP 180 Plain wing |  | Removable decorative front panels are a universal solution allowing to choose the design of a fan or ventilation grille for any interior of a bathroom or kitchen. |
| FPB 180/125 Disc |  | Removable decorative front panels are a universal solution allowing to choose the design of a fan or ventilation grille for any interior of a bathroom or kitchen. |
| FP 180 Aqua |  | Removable decorative front panels are a universal solution allowing to choose the design of a fan or ventilation grille for any interior of a bathroom or kitchen. |
| FP 180 Mars |  | Removable decorative front panels are a universal solution allowing to choose the design of a fan or ventilation grille for any interior of a bathroom or kitchen. |
| FP 180 Mystery |  | Removable decorative front panels are a universal solution allowing to choose the design of a fan or ventilation grille for any interior of a bathroom or kitchen. |
| FP 180 Plain chrome |  | Removable decorative front panels are a universal solution allowing to choose the design of a fan or ventilation grille for any interior of a bathroom or kitchen. |
| FP 180 Plain alumat |  | Removable decorative front panels are a universal solution allowing to choose the design of a fan or ventilation grille for any interior of a bathroom or kitchen. |
| FPB 180/125 Glass-1 |  | Removable decorative front panels are a universal solution allowing to choose the design of a fan or ventilation grille for any interior of a bathroom or kitchen. |
| FPB 180/125 Glass-1 red |  | Removable decorative front panels are a universal solution allowing to choose the design of a fan or ventilation grille for any interior of a bathroom or kitchen. |
| FPB 180/125 Glass-1 black |  | Removable decorative front panels are a universal solution allowing to choose the design of a fan or ventilation grille for any interior of a bathroom or kitchen. |

| | | |
|-----------------------------------|---|--|
| FP 180 Plain gold |  | Removable decorative front panels are a universal solution allowing to choose the design of a fan or ventilation grille for any interior of a bathroom or kitchen. |
| FP 180 Plain dim |  | Removable decorative front panels are a universal solution allowing to choose the design of a fan or ventilation grille for any interior of a bathroom or kitchen. |

Flanges

| Name | Photo | Description |
|------------------------|---|--|
| FO 125 |  | The window flange applicable for all VENTS fans except for VKO, VKO1, iFan, Quiet, MAO, CF |

Ecodesign

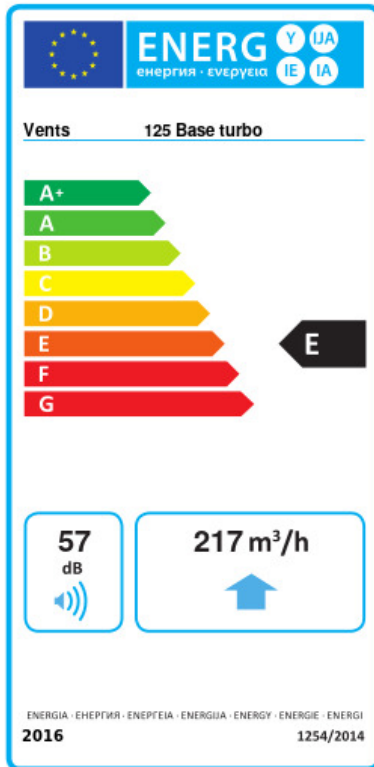

| | | | | | | |
|---|----------------|---|---------|---|------|---|
| Trademark | Vents | | | | | |
| Model | 125 Base turbo | | | | | |
| Specific energy consumption (SEC) (kWh/(m ² /a)) | Cold | | Average | | Warm | |
| | -31.1 | B | -14.7 | E | -5.3 | F |
| Type of ventilation unit | Unidirectional | | | | | |
| Type of drive installed | Single speed | | | | | |
| Type of heat recovery system | None | | | | | |
| Maximum flow rate (m ³ /h) | 217 | | | | | |
| Electric power input (W) | 17 | | | | | |
| Reference flow rate (m ³ /s) | 0.042 | | | | | |
| Specific power input (SPI) (W/(m ³ /h)) | 0.078 | | | | | |
| Control typology | Manual control | | | | | |
| Maximum external leakage rates (%) | 2.7 | | | | | |
| Declared typology | RVU UVU | | | | | |
| Sound power level (dB(A)) | 57 | | | | | |
| The annual electricity consumption (AEC) (kWh/a) | Cold | | Average | | Warm | |
| | 98 | | 98 | | 98 | |
| The annual heating saved (AHS) (kWh/a) | Cold | | Average | | Warm | |
| | 3355 | | 1715 | | 776 | |