

125 LD Light



Exhaust axial decorative fans

- Maximum airflow: 167
- Sound pressure level LpA at 3 m: 34
- Motor type: AC
- Casing material: Plastic

	Unit of measurement	125 LD Light
Connected air duct size	mm	125
Speed	-	1
Minimum supply voltage	V	220
Maximum supply voltage	V	240
Power supply frequency	Hz	50
Rated power	W	16
Unit current	A	0.1
Maximum airflow	m ³ /h	167
Sound pressure level LpA at 3 m	dB(A)	34
Weight	kg	0.89
Ambient air temperature min	°C	1
Ambient air temperature max	°C	40
Ingress protection rating	-	IP34
ErP compliance	-	2016
Cold - Specific energy consumption (SEC)	kWh/(m ² /a)	32
SEC Class Cold	-	B
Average - Specific energy consumption (SEC)	kWh/(m ² /a)	15
SEC Class Average	-	E
Warm - Specific energy consumption (SEC)	kWh/(m ² /a)	6
SEC Class Warm	-	F
Unit category	-	RVU

Type of ventilation unit	-	Unidirectional
Type of drive installed	-	Multi-speed
Type of heat recovery system	-	None
Maximum flow rate	m ³ /h	167
Electric power input	W	16
Reference flow rate	m ³ /s	0.032
Specific power input (SPI)	W/(m ³ /h)	0.062
Control typology	-	Manual control
Maximum external leakage rates	%	2.7
Cold - The annual electricity consumption (AEC)	kWh/a	100
Average - The annual electricity consumption (AEC)	kWh/a	100
Warm - Jährlicher Stromverbrauch (JSV)	kWh/a	100
Cold - The annual heating saved (AHS)	kWh/a	3400
The annual heating saved (AHS) Average	kWh/a	1700
The annual heating saved (AHS) Warm	kWh/a	800
Sound power level	dB(A)	54
Declared typology	-	RVU UVU

Dimensions

Ø D	B	L	L1
125	187	135	101

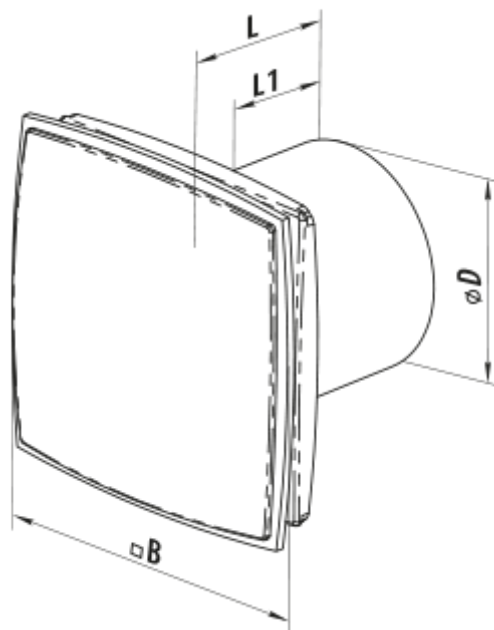

Accessories

Cooker Hoods

Name	Photo	Description
FO_125		The window flange applicable for all VENTS fans except for VKO, VKO1, iFan, Quiet, MAO, CF