

## AOE 30



Air heating units with electric heaters for air heating of various premises

- Maximum airflow: 4000
- Sound pressure level LpA at 3 m: 61
- Motor type: AC
- Casing material: Coated steel

	Unit of measurement	AOE 30
Phases	-	3
Minimum supply voltage	V	400
Maximum supply voltage	V	400
Power supply frequency	Hz	50
Rated power	W	253
Unit current	A	1.1
Maximum airflow	m <sup>3</sup> /h	4000
Sound pressure level LpA at 3 m	dB(A)	61
Weight	kg	48
Ingress protection rating	-	IP21

### Dimensions

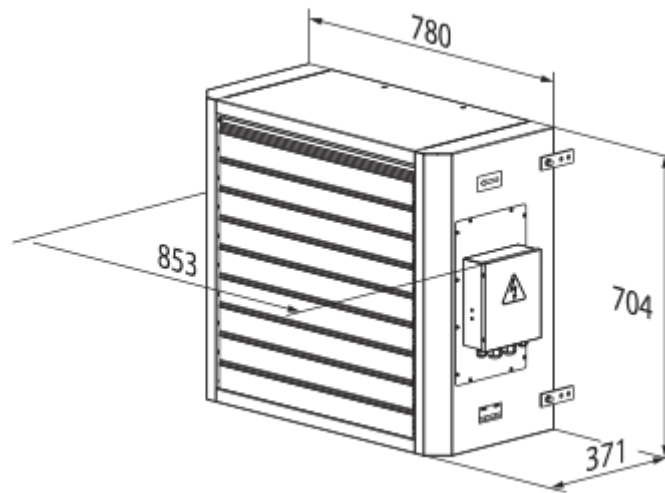



## Accessories

### Temperature regulators

Name	Photo	Description
<a href="#">TST-1-300</a>		Temperature regulator
<a href="#">TSTD-1-300</a>		Temperature regulator
<a href="#">RTS-1-400</a>		Temperature regulator
<a href="#">RTSD-1-400</a>		Temperature regulator

### Other accessories

Name	Photo	Description
UET-30D		Control unit
MKP-AOW		Mounting angles
MK-AOW 45		Mounting brackets