

AOW1 25



Air unit with the water heat exchanger for arrangement of cost-saving and efficient air heating in various premises

- Maximum airflow: 2200
- Sound pressure level LpA at 3 m: 53
- Motor type: AC
- Casing material: Coated steel

| | Unit of measurement | AOW1 25 |
|---------------------------------|---------------------|---------|
| Phases | - | 1 |
| Minimum supply voltage | V | 230 |
| Maximum supply voltage | V | 230 |
| Power supply frequency | Hz | 50 |
| Rated power | W | 136 |
| Unit current | A | 0.6 |
| Maximum airflow | m ³ /h | 2200 |
| Sound pressure level LpA at 3 m | dB(A) | 53 |
| Weight | kg | 28 |
| Ingress protection rating | - | IP44 |

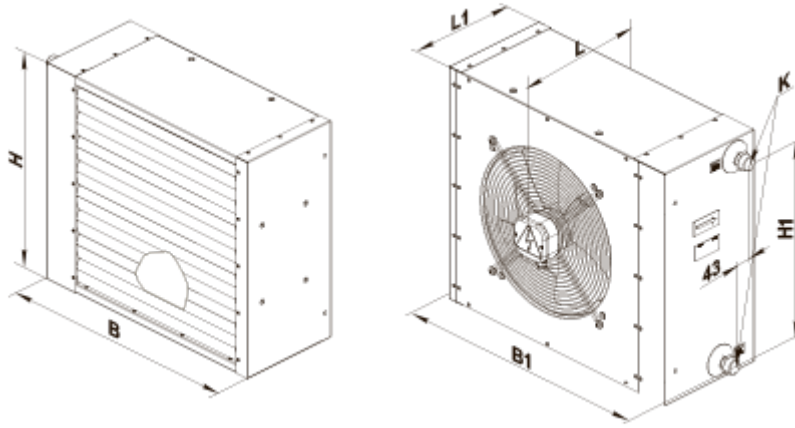

Dimensions

| B | B1 | H | H1 | L | L1 | K |
|-----|-----|-----|-----|-----|-----|--------|
| 630 | 690 | 555 | 468 | 320 | 262 | G 3/4" |





Accessories

Other accessories

| Name | Photo | Description |
|------------|---|-------------------|
| UWT-1E |  | Control unit |
| MKP-AOW |  | Mounting angles |
| MK-AOW1 25 |  | Mounting brackets |

Temperature regulators

| Name | Photo | Description |
|----------------------------|---|-----------------------|
| TST-1-300 |  | Temperature regulator |
| TSTD-1-300 |  | Temperature regulator |
| RTS-1-400 |  | Temperature regulator |
| RTSD-1-400 |  | Temperature regulator |