

Arc black



Intelligent axial fans for extract ventilation

- Maximum airflow: 140
- Sound pressure level LpA at 3 m: 28
- Lighting
- Motor type: DC
- Control: Built-in control panel
- Impeller type: Axial
- Motion sensor
- Humidity sensor: Built-in
- Temperature sensor: Built-in
- Timer: Turn off timer, Turn on timer

	Unit of measurement	Arc black					
Connected air duct size	mm	125/100					
Speed	-	6					
Minimum supply voltage	V	100					
Maximum supply voltage	V	240					
Power supply frequency	Hz	50/60					
Rated power	W	0.4	0.6	0.8	1.6	2.7	2.9
Unit current	A	0.018	0.019	0.021	0.029	0.038	0.04
Maximum airflow	m ³ /h	20	40	60	90	115	140
Sound pressure level LpA at 3 m	dB(A)	9	13	18	22	27	28
Ingress protection rating	-	IP44					

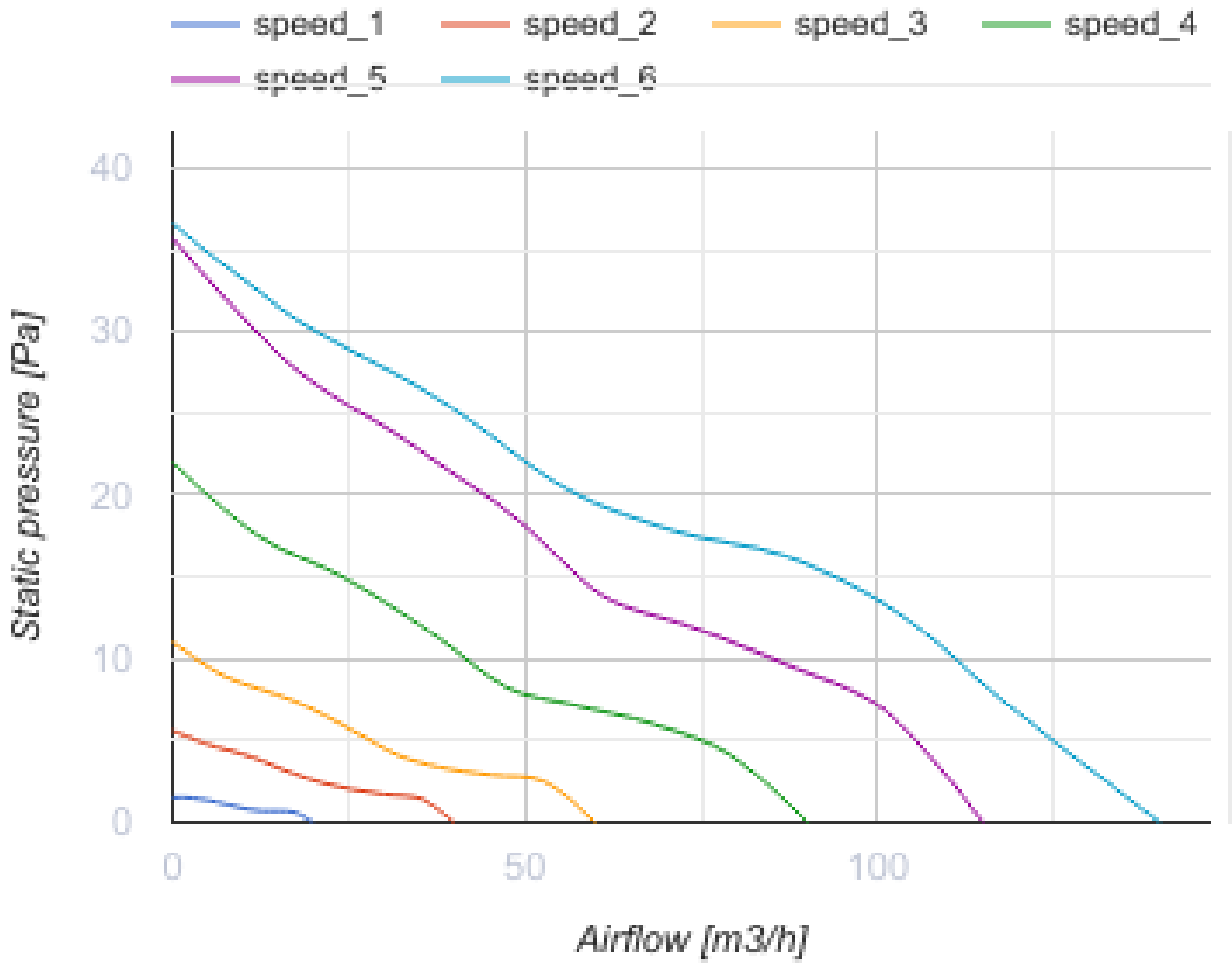



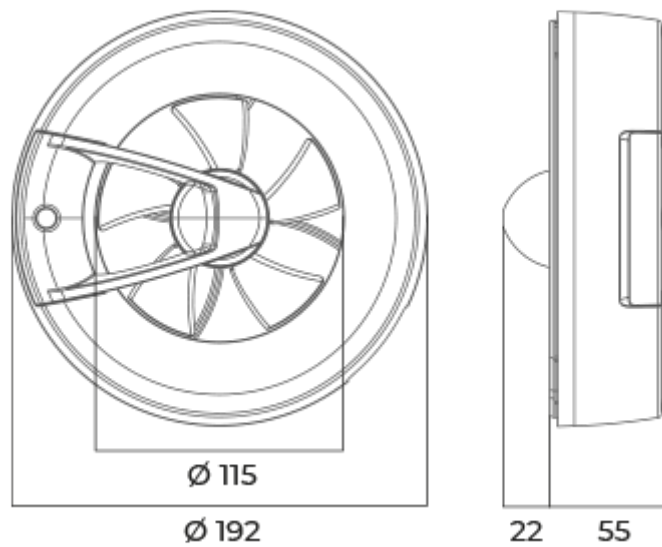

Dimensions



Accessories

Flat duct

Name	Photo	Description
1805		Wall mounting
1810		Wall mounting
2805		Wall mounting
2810		Wall mounting

Plastic

Name	Photo	Description
MV 100		Supply and exhaust plastic grilles
MV 120		Supply and exhaust plastic grilles