

# Arc Smart black



Intelligent low noise fan for exhaust ventilation

- Maximum airflow: 140
- Sound pressure level LpA at 3 m: 28
- Lighting
- Motor type: DC
- Control: Smartphone
- Impeller type: Axial
- Motion sensor
- Humidity sensor: Built-in
- VOC sensor
- Timer: Turn off timer, Turn on timer



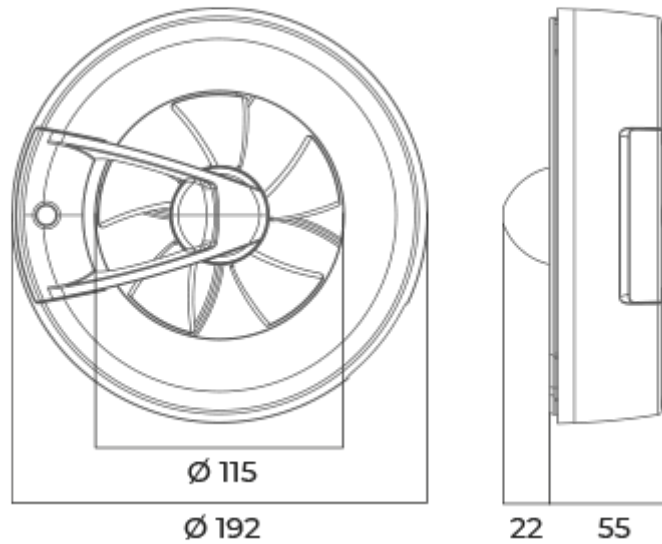

	Unit of measurement	Arc Smart black					
Connected air duct size	mm	100/125					
Speed	-	6					
Minimum supply voltage	V	100					
Maximum supply voltage	V	240					
Power supply frequency	Hz	50/60					
Rated power	W	0.4	0.6	0.8	1.6	2.7	2.9
Unit current	A	0.018	0.019	0.021	0.029	0.038	0.04
Maximum airflow	m <sup>3</sup> /h	20	40	60	90	115	140
Sound pressure level LpA at 3 m	dB(A)	9	13	18	22	27	28
Ingress protection rating	-	IP44					

## Dimensions





## Accessories

### Flat duct

Name	Photo	Description
<a href="#">1805</a>		Wall mounting
<a href="#">1810</a>		Wall mounting
<a href="#">2805</a>		Wall mounting
<a href="#">2810</a>		Wall mounting

### Plastic

Name	Photo	Description
<a href="#">MV 100</a>		Supply and exhaust plastic grilles
<a href="#">MV 120</a>		Supply and exhaust plastic grilles