

# Boost-I 250 T



Mixed-flow inline fans in sound-insulated casings

- Maximum airflow: 1670
- Sound pressure level LpA at 3 m: 45
- Sound insulation
- Motor type: AC
- Impeller type: Mixed-flow
- Casing material: Galvanized steel
- Installation in any position
- Timer: Turn off timer

	Unit of measurement	Boost-I 250 T		
Connected air duct size	mm	250		
Speed	-	3		
Phases	-	1		
Minimum supply voltage	V	230		
Maximum supply voltage	V	230		
Power supply frequency	Hz	50		
Rated power	W	144	173	188
Unit current	A	0.70	0.81	0.84
Maximum airflow	m <sup>3</sup> /h	1007	1404	1670
rotation speed at 50hz	-	2292	2626	2876
Sound pressure level LpA at 3 m	dB(A)	38	43	45
Weight	kg	9.8		
Transported air temperature (max)	°C	55		
Transported air temperature (min)	°C	-25		
Ambient air temperature min	°C	1		
Ambient air temperature max	°C	40		
Ingress protection rating	-	IPX4		
Ingress protection rating of the drive	-	IP20		

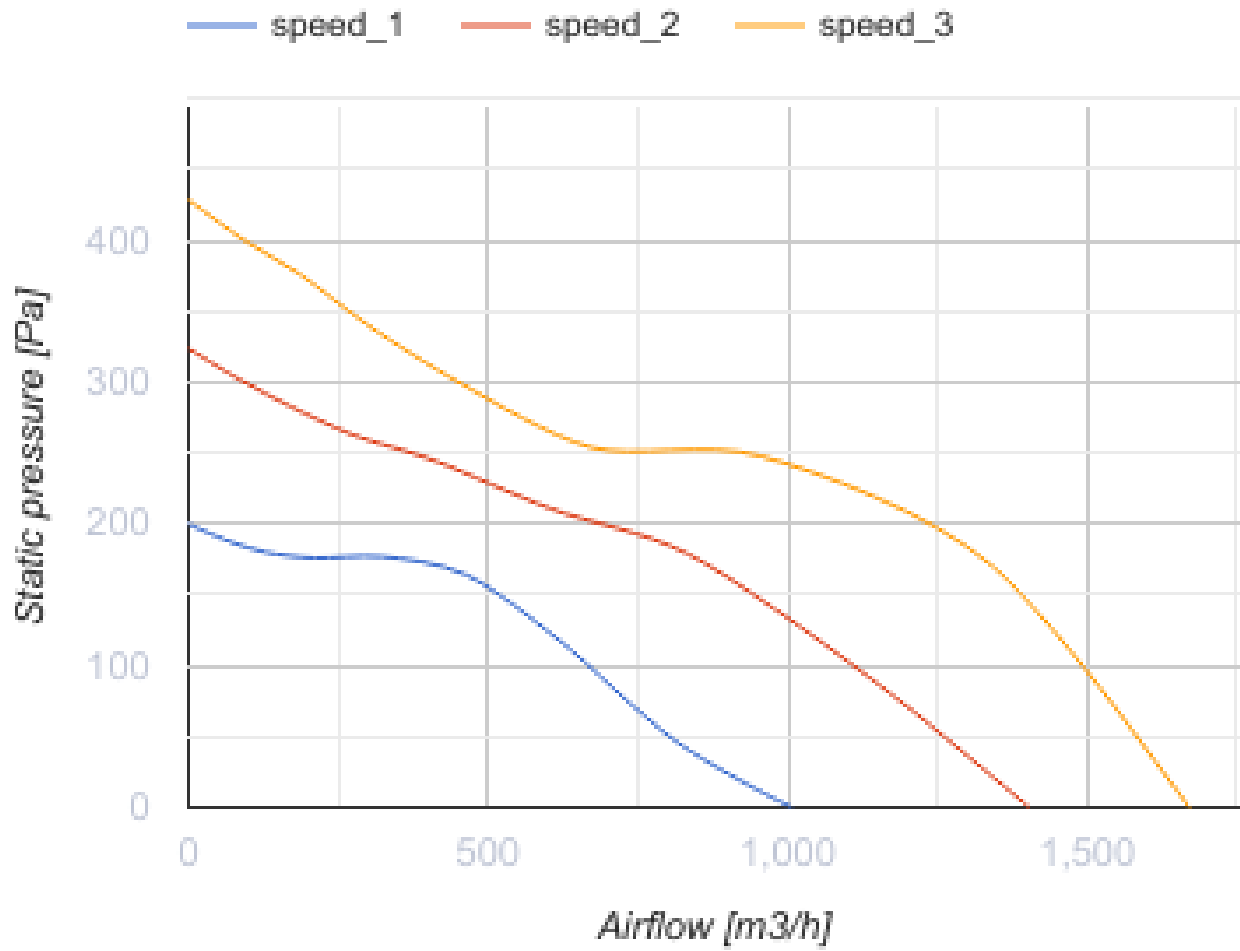





### Dimensions

ØD	ØD1	L	L1	B
249	337	601	739	389







## Accessories





### For round ducts

Name	Photo	Description
<a href="#">SR 250/600</a>		Silencers made of galvanized steel filled with non-combustible sound-absorbing material
<a href="#">SR 250/900</a>		Silencers made of galvanized steel filled with non-combustible sound-absorbing material
<a href="#">SR 250/1200</a>		Silencers made of galvanized steel filled with non-combustible sound-absorbing material



### For round ducts

Name	Photo	Description
<a href="#">FB 250</a>		Round panel air filters
<a href="#">FBK 250-4</a>		Round bag air filters
<a href="#">FBK 250-5</a>		Round bag air filters
<a href="#">FBK 250-7</a>		Round bag air filters



### Electrical heaters

Name	Photo	Description
<a href="#">NK 250-1,2-1</a>		Round electric inline heaters with round cross-section
<a href="#">NK 250-2,0-1</a>		Round electric inline heaters with round cross-section
<a href="#">NK 250-2,4-1</a>		Round electric inline heaters with round cross-section
<a href="#">NK 250-3,0-1</a>		Round electric inline heaters with round cross-section

### Water heaters

Name	Photo	Description
<a href="#">NKV 250-2</a>		Inline water supply air heaters or heater for air handling units with a round cross-section
<a href="#">NKV 250-4</a>		Inline water supply air heaters or heater for air handling units with a round cross-section



### For round ducts

Name	Photo	Description
<a href="#">KOM 250</a>		Backdraught damper with spring-loaded plates for shutting off air flow in round air ducts
<a href="#">KOMu 250</a>		Backdraught damper with spring-loaded plates for shutting off air flow in round air ducts
<a href="#">KR 250</a>		Air dampers for controlling air flow in round air ducts

### Speed control switches

Name	Photo	Description
<a href="#">P3-1-300</a>		Switch

### Speed controllers

Name	Photo	Description
<a href="#">RS-1,5-PS</a>		Used in ventilation systems for switching on/off and speed control of single-phase fan motors with voltage control
<a href="#">RS-1-400</a>		Speed controller
<a href="#">RS-3,0-T</a>		Applied in ventilation systems for speed switching ON/OFF and speed control of single-phase power-controlled motors