

# Boost-I 355 EC R



Mixed-type duct fans with EC motors in casing with noise and heat insulation

- Maximum airflow: 3500
- Sound pressure level LpA at 3 m: 48
- Sound insulation
- Motor type: EC
- Impeller type: Mixed-flow
- Casing material: Galvanized steel
- Installation in any position
- Cable with mains plug

	Unit of measurement	Boost-I 355 EC R
Connected air duct size	mm	355
Speed	-	1
Phases	-	1
Minimum supply voltage	V	230
Maximum supply voltage	V	230
Power supply frequency	Hz	50/60
Rated power	W	353
Unit current	A	1.56
Maximum airflow	m <sup>3</sup> /h	3500
rotation speed at 50hz	-	2470
Sound pressure level LpA at 3 m	dB(A)	48
Weight	kg	20.7
Transported air temperature (max)	°C	55
Transported air temperature (min)	°C	-25
Ambient air temperature min	°C	1
Ambient air temperature max	°C	40
Ingress protection rating	-	IPX4
Ingress protection rating of the drive	-	IP44

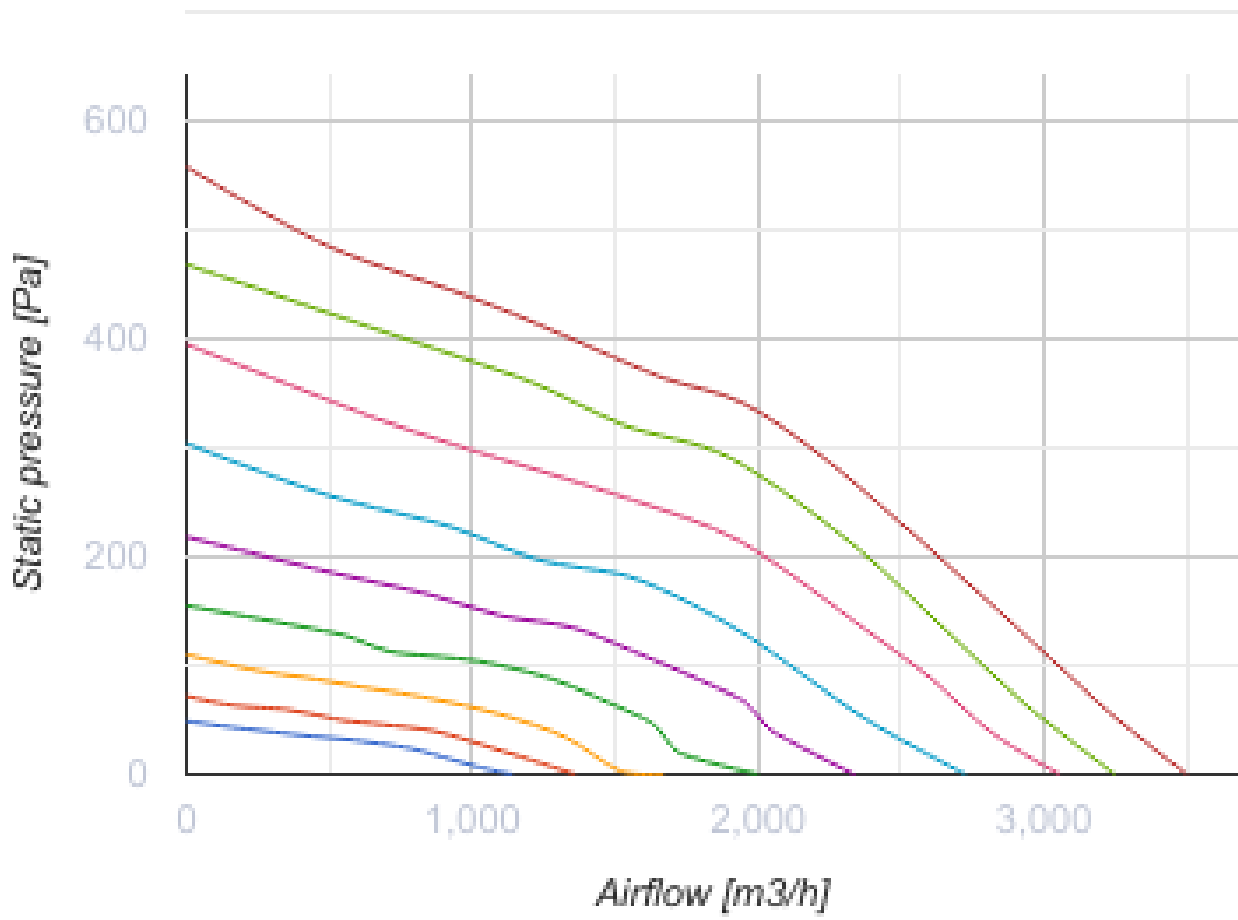

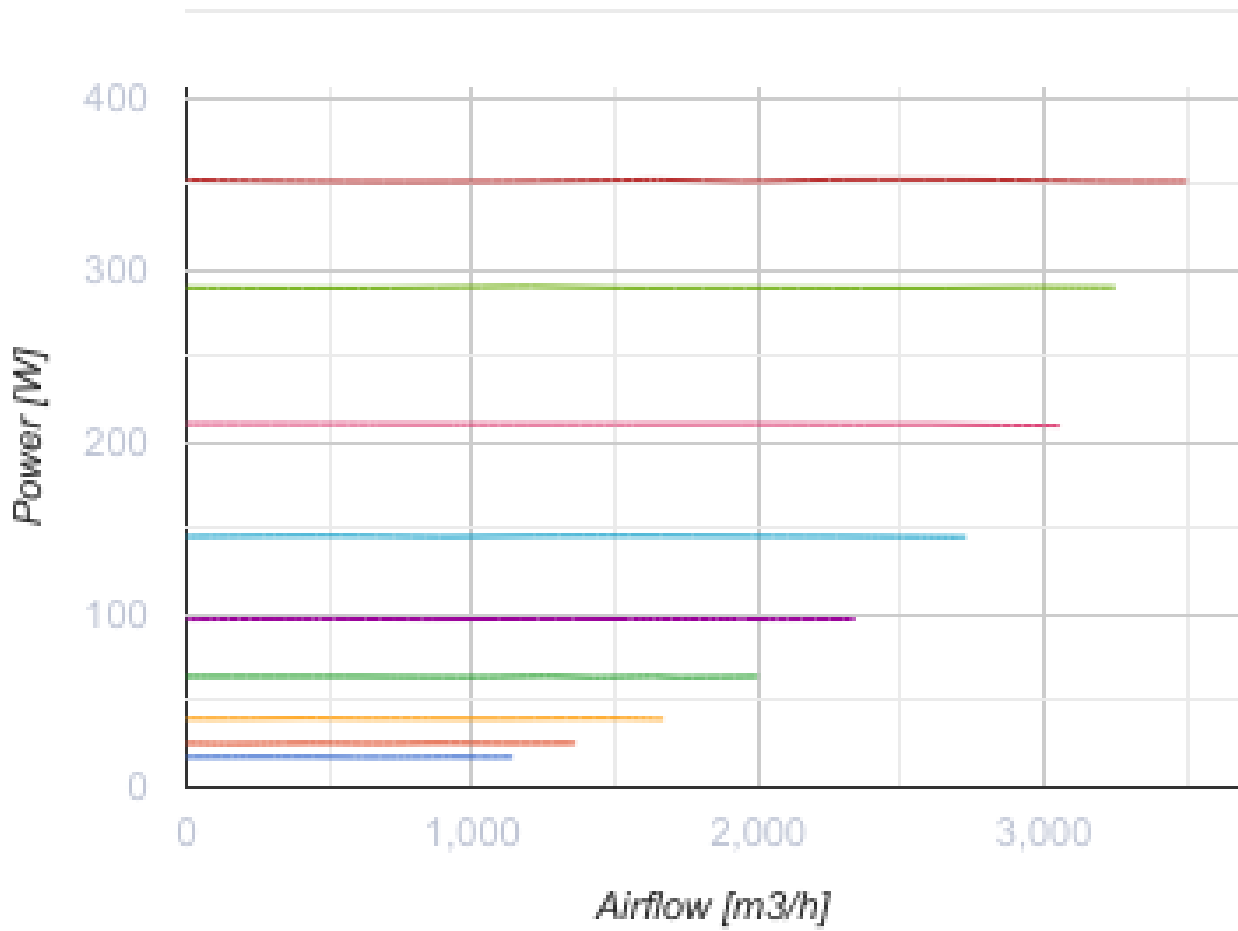

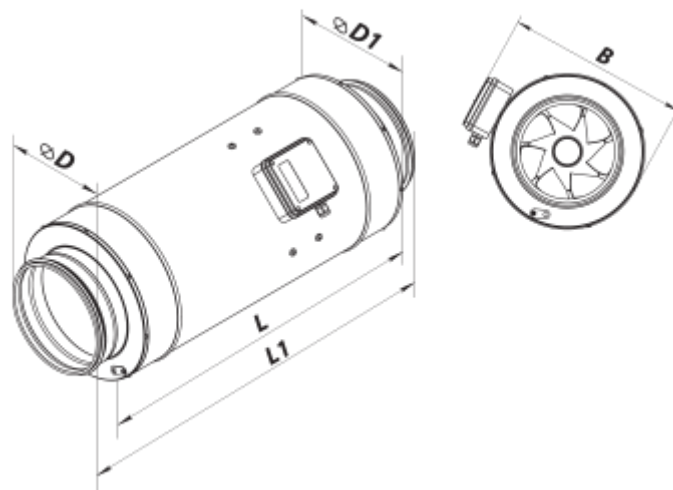

**Dimensions**

$\varnothing D$	$\varnothing D1$	B	L	L1
354	412	471	601	739



## Accessories

### For round ducts

Name	Photo	Description
<a href="#">SR 355/600</a>		Silencer is applied for noise absorption produced during the ventilating equipment operation and spread along the ducting systems
<a href="#">SR 355/900</a>		Silencer is applied for noise absorption produced during the ventilating equipment operation and spread along the ducting systems
<a href="#">SR 355/1200</a>		Silencer is applied for noise absorption produced during the ventilating equipment operation and spread along the ducting systems

### For round ducts

Name	Photo	Description
<a href="#">KR 355</a>		Air damper for air flow control in round air ducts

### Speed controllers

Name	Photo	Description
<a href="#">R-1/010</a>		Speed controller for EC motors