

CBF 110 DC Light



Centrifugal ceiling fans with integrated LED-light

- Maximum airflow: 187
- Sound pressure level LpA at 3 m: 25
- Lighting
- Motor type: DC
- Control: Built-in control panel
- Casing material: Galvanized steel
- Backdraft protection: Backdraft damper
- Timer: Turn off timer

	Unit of measurement	CBF 110 DC Light	
Connected air duct size	mm	100	125
Phases	-	1	
Minimum supply voltage	V	120	
Maximum supply voltage	V	240	
Power supply frequency	Hz	50/60	
Rated power	W	19	
Unit current	A	0.18	
Maximum airflow	m ³ /h	187	
Sound pressure level LpA at 3 m	dB(A)	25	
Weight	kg	6.4	
Ambient air temperature min	°C	1	
Ambient air temperature max	°C	40	
Ingress protection rating	-	IPX2	

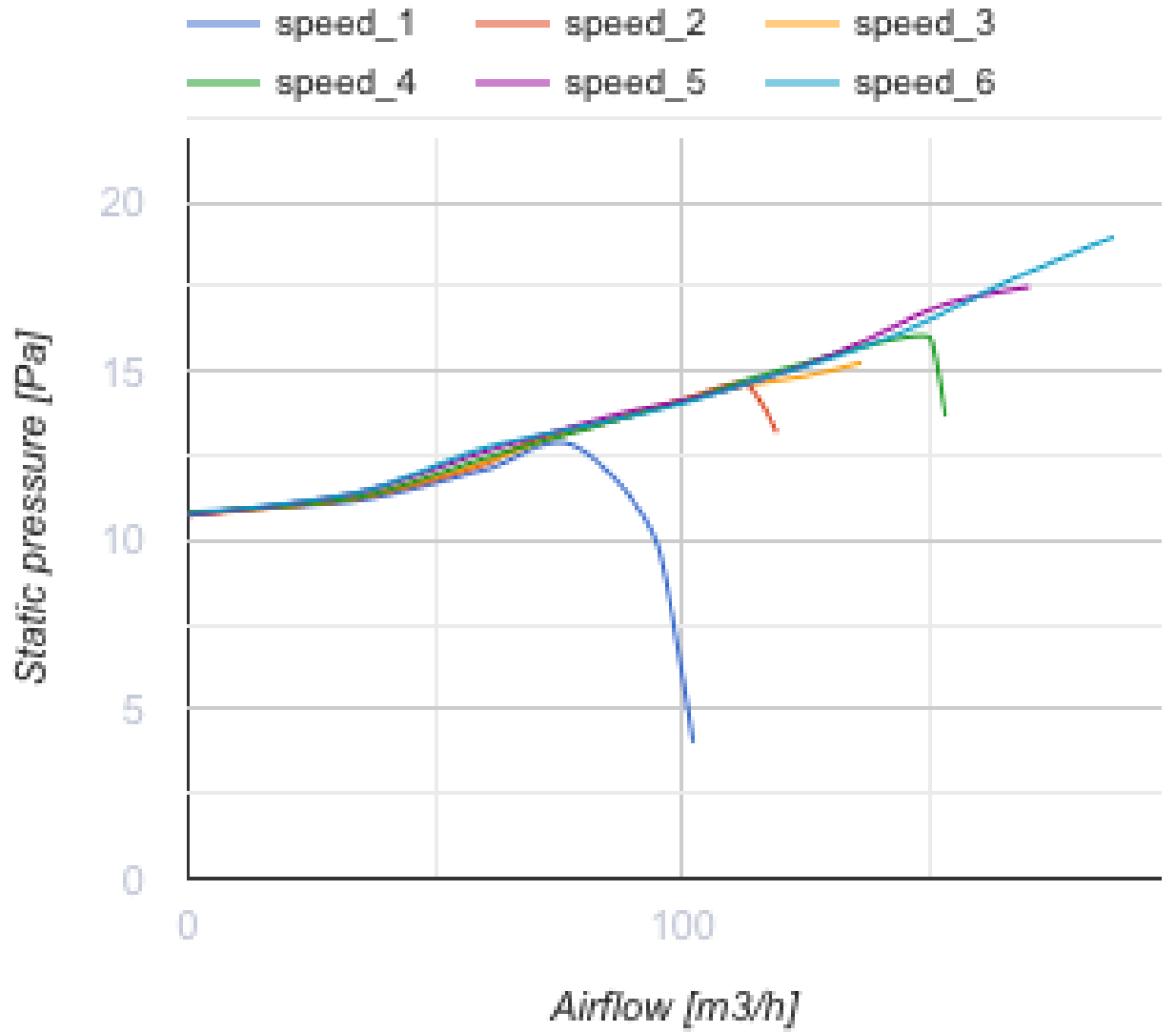

Dimensions

D	d	L1	L2	A	B	C	E	H	h	a	b
148	98	100	45	330	258	260	395	188	62	208	123

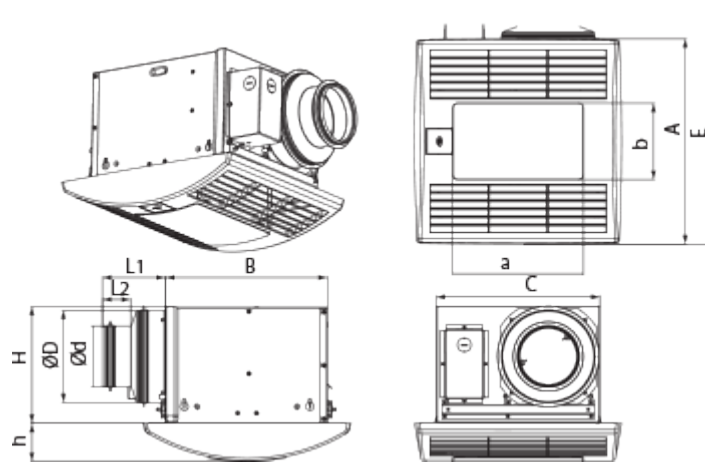





Accessories

Speed control switches

Name	Photo	Description
P2-10		Turning fan on/off and speed switching for multispeed fans

Other accessories

Name	Photo	Description
TH CBF		Humidity sensor
MV 102 V ASA		Supply and exhaust hoods
MV 152 V ASA		Supply and exhaust hoods
TP CBF		Motion sensor
CH-PLC-10WG23		10 W LED light with colour temperature 3000 K

Other accessories



Name	Photo	Description
MVM 102 bVs N		Supply and exhaust metal hoods

MVM 152 bVs N		Supply and exhaust metal hoods
-------------------------------	---	--------------------------------

Flexible ducts

Name	Photo	Description
Polyvent 660		Flexible PVC film non-insulated air ducts with steel wire frame (65 µm)

Fittings

Name	Photo	Description
CB 60-110		The clamps are designed for quick and reliable mounting and connection of various round ventilation system components. Clamps are the stainless steel quick-release clamps equipped with a stainless steel swing screw
CB 60-165		The clamps are designed for quick and reliable mounting and connection of various round ventilation system components. Clamps are the stainless steel quick-release clamps equipped with a stainless steel swing screw