

CBF 150 DC Light



Centrifugal ceiling fans with integrated LED-light

- Maximum airflow: 254
- Sound pressure level LpA at 3 m: 29
- Lighting
- Motor type: DC
- Control: Built-in control panel
- Casing material: Galvanized steel
- Backdraft protection: Backdraft damper
- Timer: Turn off timer

	Unit of measurement	CBF 150 DC Light
Connected air duct size	mm	150
Phases	-	1
Minimum supply voltage	V	120
Maximum supply voltage	V	240
Power supply frequency	Hz	50/60
Rated power	W	26
Unit current	A	0.24
Maximum airflow	m ³ /h	254
Sound pressure level LpA at 3 m	dB(A)	29
Weight	kg	6.2
Ambient air temperature min	°C	1
Ambient air temperature max	°C	40
Ingress protection rating	-	IPX2
ErP compliance	-	2016
Cold - Specific energy consumption (SEC)	kWh/(m ² /a)	33.8
SEC Class Cold	-	B
Average - Specific energy consumption (SEC)	kWh/(m ² /a)	15.9
SEC Class Average	-	E
Warm - Specific energy consumption (SEC)	kWh/(m ² /a)	5.6
SEC Class Warm	-	F
Unit category	-	RVU

Type of ventilation unit	-	Unidirectional
Type of drive installed	-	Variable speed
Type of heat recovery system	-	None
Maximum flow rate	m ³ /h	100
Electric power input	W	14
Reference flow rate	m ³ /s	0.044
Reference pressure difference	Pa	50
Specific power input (SPI)	W/(m ³ /h)	0.1
Control typology	-	Clock control
Maximum external leakage rates	%	2.7
Cold - The annual electricity consumption (AEC)	kWh/a	113
Average - The annual electricity consumption (AEC)	kWh/a	113
Warm - Jährlicher Stromverbrauch (JSV)	kWh/a	113
Cold - The annual heating saved (AHS)	kWh/a	3667
The annual heating saved (AHS) Average	kWh/a	1874
The annual heating saved (AHS) Warm	kWh/a	848
Sound power level	dB(A)	53
Declared typology	-	RVU UVU

Dimensions

D	L1	A	B	C	E	H	h	a	b
149	50	330	258	260	395	188	62	208	123

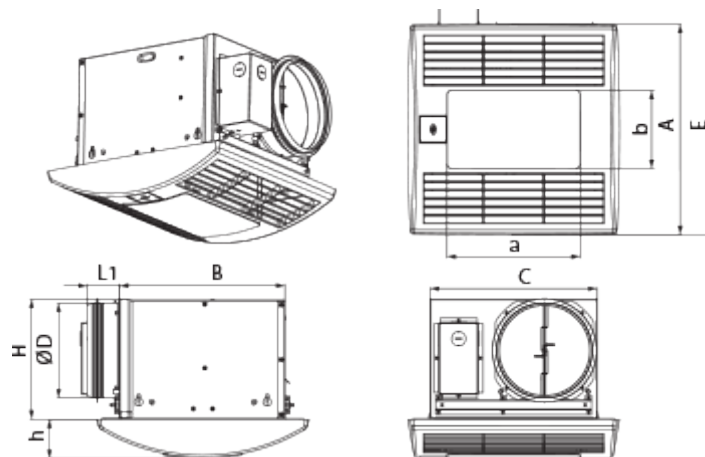

Accessories

Speed control switches



Name	Photo	Description
------	-------	-------------

P2-10		Turning fan on/off and speed switching for multispeed fans
-----------------------	---	--

Sensors

Name	Photo	Description
TH.CBF		Humidity sensor

Other accessories

Name	Photo	Description
MV 152 bVs N		Supply and exhaust metal hoods
MV 152 V ASA		Supply and exhaust hoods



Flexible ducts

Name	Photo	Description
Polyvent 660		Flexible PVC film non-insulated air ducts with steel wire frame (65 µm)

Other accessories

Name	Photo	Description
CB 60-165		The clamps are designed for quick and reliable mounting and connection of various round ventilation system components. Clamps are the stainless steel quick-release clamps equipped with a stainless steel swing screw

Electrical accessories

Name	Photo	Description
TP.CBF		Motion sensor
CH-PLC-10WG23		10 W LED light with colour temperature 3000 K