

CBF 200 Light



Centrifugal ceiling fans with integrated LED-light

- Maximum airflow: 210
- Sound pressure level LpA at 3 m: 27
- Lighting
- Motor type: AC
- Casing material: Galvanized steel
- Backdraft protection: Backdraft damper
- Timer: Turn off timer

	Unit of measurement	CBF 200 Light	
Connected air duct size	mm	100	150
Phases	-	1	
Minimum supply voltage	V	220	
Maximum supply voltage	V	240	
Power supply frequency	Hz	50/60	
Rated power	W	20	29
Unit current	A	0.1	0.13
Maximum airflow	m ³ /h	130	210
Sound pressure level LpA at 3 m	dB(A)	24	27
Weight	kg	5.3	
Ambient air temperature min	°C	1	
Ambient air temperature max	°C	40	
Ingress protection rating	-	IPX2	

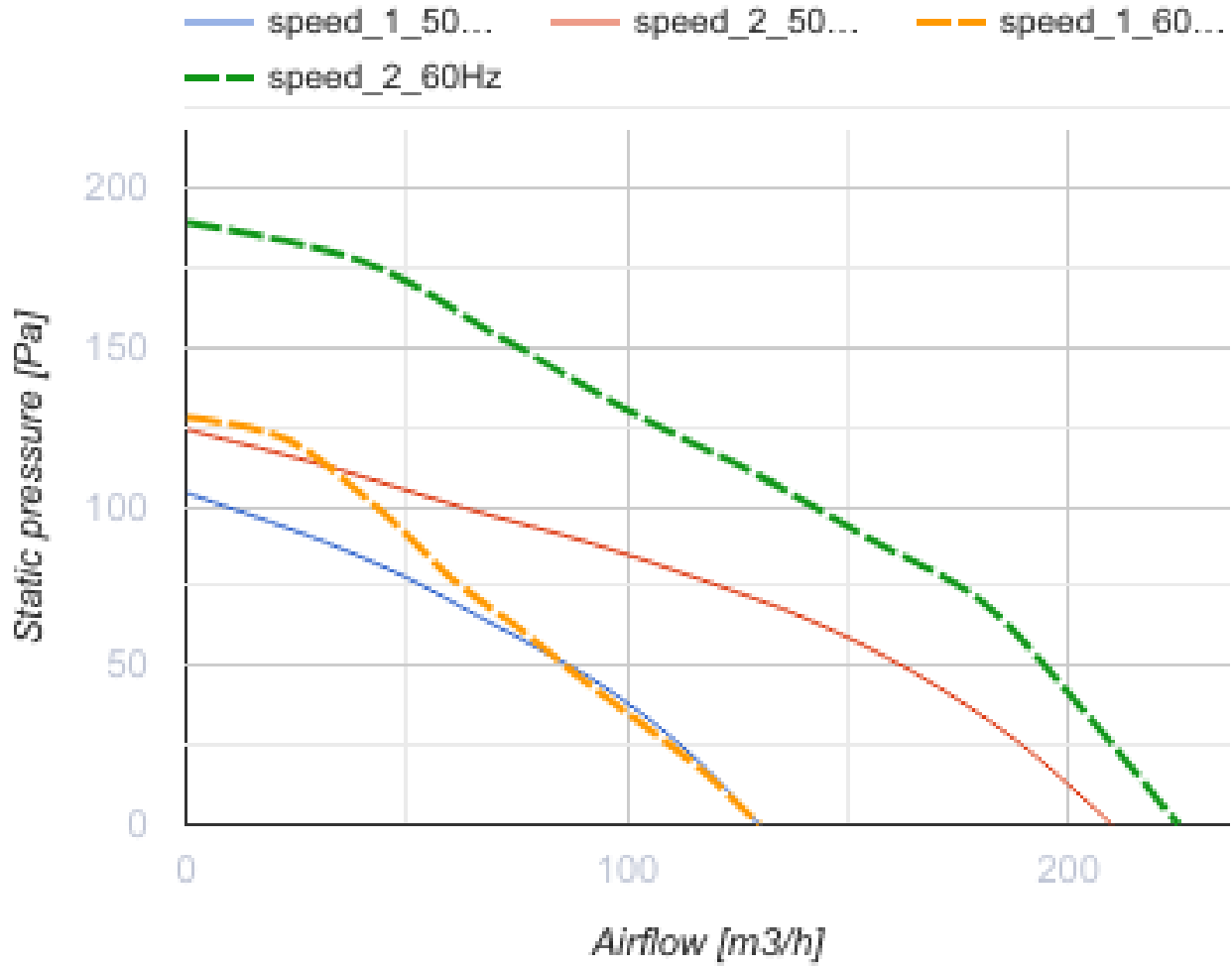

Dimensions

D	d	L1	L2	A	B	C	E	H	h	a	b
148	98	100	45	330	258	260	395	188	62	208	123

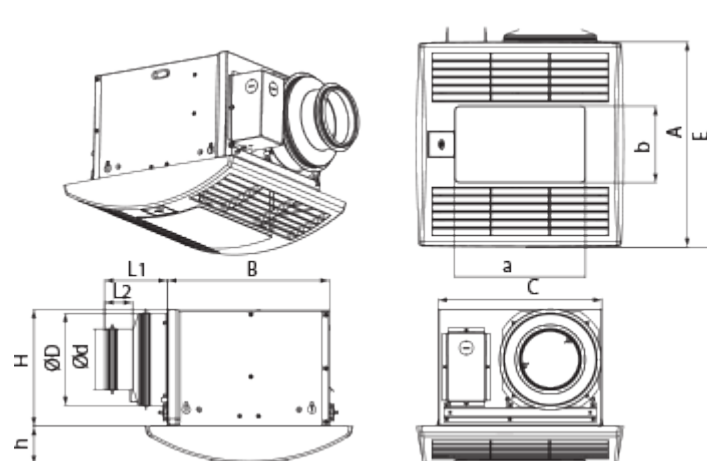



Accessories

Speed control switches

Name	Photo	Description
P2-10		Turning fan on/off and speed switching for multispeed fans

Other accessories

Name	Photo	Description
MVM 102 bVs N		Supply and exhaust metal hoods
MVM 152 bVs N		Supply and exhaust metal hoods

Other accessories

Name	Photo	Description
MV 102 V ASA		Supply and exhaust hoods
MV 152 V ASA		Supply and exhaust hoods
CH-PLC-10WG23		10 W LED light with colour temperature 3000 K

Flexible ducts

Name	Photo	Description
Polyvent 660		Flexible PVC film non-insulated air ducts with steel wire frame (65 µm)

Fittings

Name	Photo	Description
CB 60-110		The clamps are designed for quick and reliable mounting and connection of various round ventilation system components. Clamps are the stainless steel quick-release clamps equipped with a stainless steel swing screw

[CB 60-165](#)

The clamps are designed for quick and reliable mounting and connection of various round ventilation system components. Clamps are the stainless steel quick-release clamps equipped with a stainless steel swing screw

Ecodesign

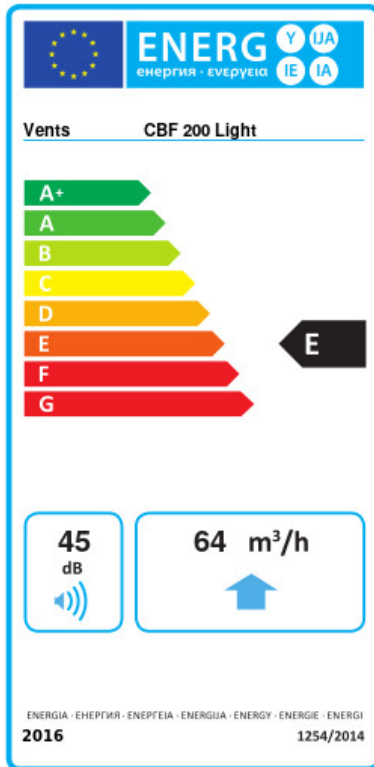

Trademark	Vents					
Model	CBF 200 Light					
Specific energy consumption (SEC) (kWh/(m ² /a))	Cold		Average		Warm	
	-26.9	B	-10.5	E	-1.1	F
Type of ventilation unit	Unidirectional					
Type of drive installed	2-speed					
Type of heat recovery system	None					
Maximum flow rate (m ³ /h)	64					
Electric power input (W)	25.5					
Reference flow rate (m ³ /s)	0.024					
Reference pressure difference (Pa)	50					
Specific power input (SPI) (W/(m ³ /h))	0.212					
Control typology	Manual control					
Maximum external leakage rates (%)	2.7					
Sound power level (dB(A))	45					
Declared typology	RVU UVU					
The annual electricity consumption (AEC) (kWh/a)	Cold		Average		Warm	
	265		265		265	
The annual heating saved (AHS) (kWh/a)	Cold		Average		Warm	
	3355		1715		776	