

CBF 250 Light TH



Centrifugal ceiling fans with integrated LED-light

- Maximum airflow: 260
- Sound pressure level LpA at 3 m: 29
- Lighting
- Motor type: AC
- Control: Built-in control panel
- Casing material: Galvanized steel
- Backdraft protection: Backdraft damper
- Humidity sensor
- Timer: Turn off timer

	Unit of measurement	CBF 250 Light TH	
		100	150
Connected air duct size	mm	100	150
Phases	-	1	
Minimum supply voltage	V	220	
Maximum supply voltage	V	240	
Power supply frequency	Hz	50/60	
Rated power	W	23	39
Unit current	A	0.12	0.18
Maximum airflow	m ³ /h	170	260
Sound pressure level LpA at 3 m	dB(A)	25	29
Weight	kg	5.3	
Ambient air temperature min	°C	1	
Ambient air temperature max	°C	40	
Ingress protection rating	-	IPX2	



Dimensions

D	d	L1	L2	A	B	C	E	H	h	a	b
148	98	100	45	330	258	260	395	188	62	208	123

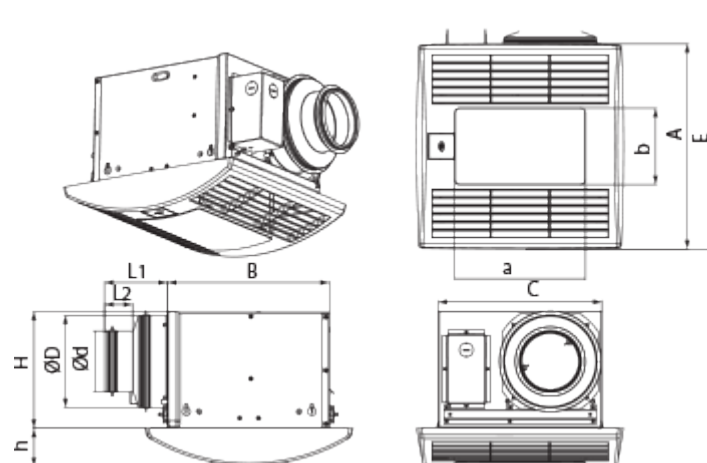

Accessories



Speed control switches

Name	Photo	Description
P2-10		Turning fan on/off and speed switching for multispeed fans

Other accessories

Name	Photo	Description
TH CBF		Humidity sensor
MV 102 V ASA		Supply and exhaust hoods
MV 152 V ASA		Supply and exhaust hoods
CH-PLC-10WG23		10 W LED light with colour temperature 3000 K

Metal

Name	Photo	Description
MVM 102 bVs N		Supply and exhaust metal hoods
MVM 152 bVs N		Supply and exhaust metal hoods

Flexible ducts

Name	Photo	Description
Polyvent 660		Flexible PVC film non-insulated air ducts with steel wire frame (65 µm)

Fittings

Name	Photo	Description
CB 60-110		The clamps are designed for quick and reliable mounting and connection of various round ventilation system components. Clamps are the stainless steel quick-release clamps equipped with a stainless steel swing screw

[CB 60-165](#)

The clamps are designed for quick and reliable mounting and connection of various round ventilation system components. Clamps are the stainless steel quick-release clamps equipped with a stainless steel swing screw

Ecodesign

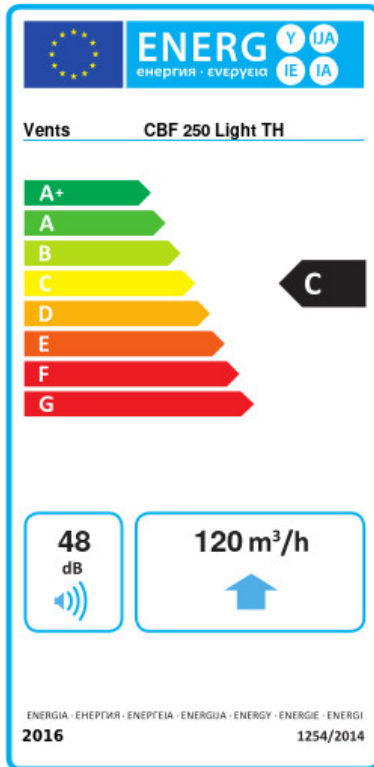

Trademark	Vents					
Model	CBF 250 Light TH					
Specific energy consumption (SEC) (kWh/(m ² /a))	Cold		Average		Warm	
	-52.4	A+	-25.3	C	-9.8	F
Type of ventilation unit	Unidirectional					
Type of drive installed	2-speed					
Type of heat recovery system	None					
Maximum flow rate (m ³ /h)	120					
Electric power input (W)	36					
Reference flow rate (m ³ /s)	0.037					
Reference pressure difference (Pa)	50					
Specific power input (SPI) (W/(m ³ /h))	0.159					
Control typology	Local demand control					
Maximum external leakage rates (%)	2.7					
Declared typology	RVU UVU					
Sound power level (dB(A))	48					
The annual electricity consumption (AEC) (kWh/a)	Cold		Average		Warm	
	119		119		119	
The annual heating saved (AHS) (kWh/a)	Cold		Average		Warm	
	5536		2830		1280	