

# CBF 300 Light T



Centrifugal ceiling fans with integrated LED-light

- Maximum airflow: 300
- Sound pressure level LpA at 3 m: 31
- Lighting
- Motor type: AC
- Control: Built-in control panel
- Casing material: Galvanized steel
- Backdraft protection: Backdraft damper
- Timer: Turn off timer

	Unit of measurement	CBF 300 Light T	
Connected air duct size	mm	150	
Phases	-	1	
Minimum supply voltage	V	220	
Maximum supply voltage	V	240	
Power supply frequency	Hz	50/60	
Rated power	W	31	49
Unit current	A	0.15	0.22
Maximum airflow	m <sup>3</sup> /h	220	300
Sound pressure level LpA at 3 m	dB(A)	28	31
Weight	kg	5.1	
Ambient air temperature min	°C	1	
Ambient air temperature max	°C	40	
Ingress protection rating	-	IPX2	

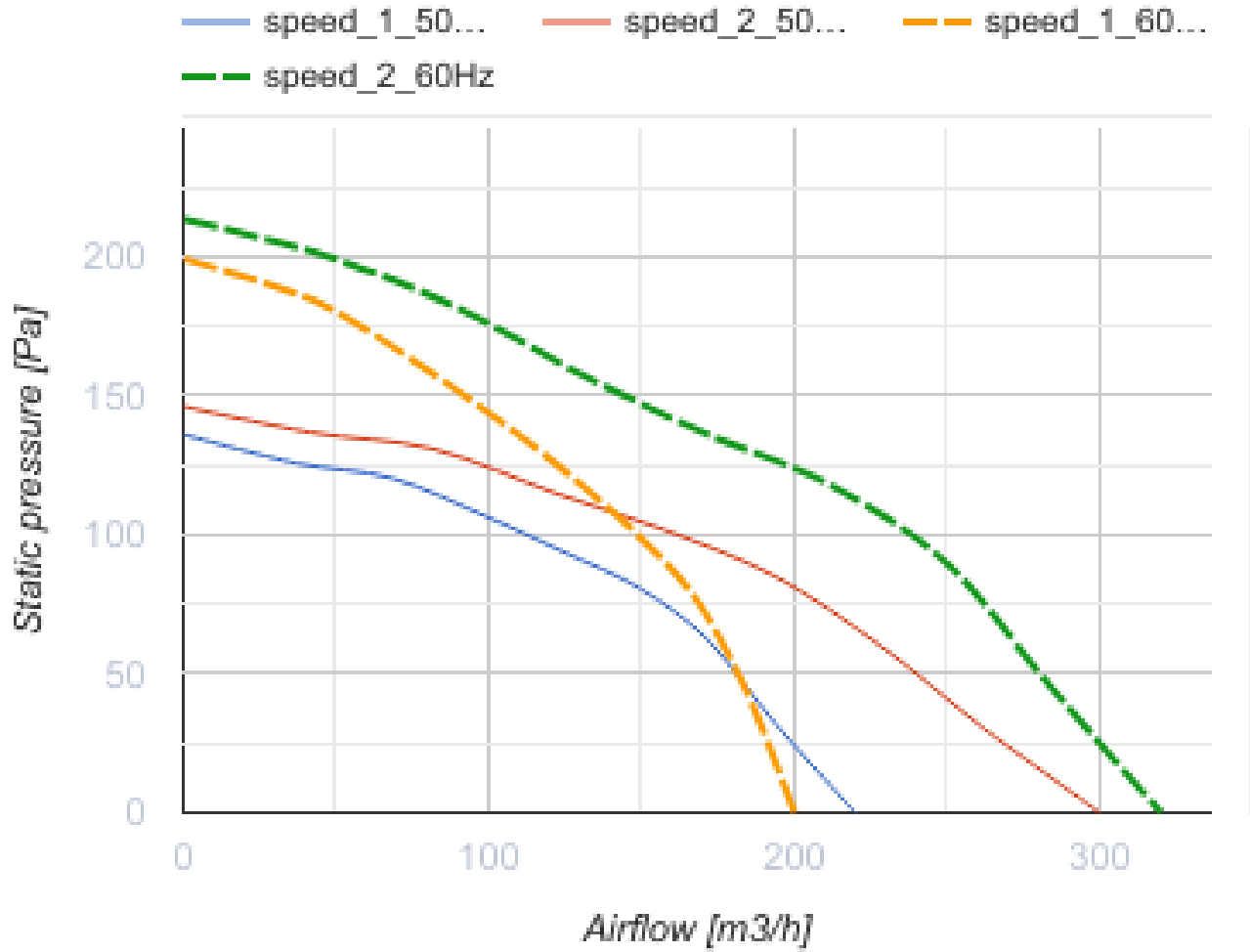

## Dimensions

D	L1	A	B	C	E	H	h	a	b
149	50	330	258	260	395	188	62	208	123

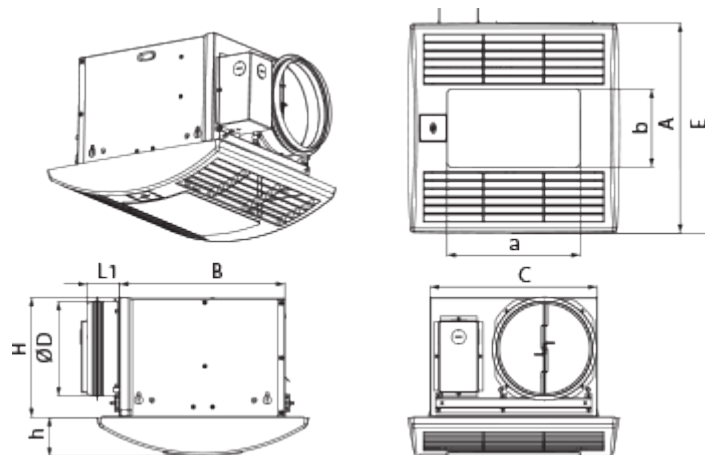





## Accessories

### Speed control switches

Name	Photo	Description
<a href="#">P2-10</a>		Turning fan on/off and speed switching for multispeed fans

### Other accessories

Name	Photo	Description
TH CBF		Humidity sensor
MV 152 V ASA		Supply and exhaust hoods
TP CBF		Motion sensor
CH-PLC-10WG23		10 W LED light with colour temperature 3000 K

### Metal

Name	Photo	Description
<a href="#">MVM 152 bVs N</a>		Supply and exhaust metal hoods

### Flexible ducts

Name	Photo	Description
<a href="#">Polyvent 660</a>		Flexible PVC film non-insulated air ducts with steel wire frame (65 µm)

### Fittings

Name	Photo	Description
<a href="#">CB 60-165</a>		The clamps are designed for quick and reliable mounting and connection of various round ventilation system components. Clamps are the stainless steel quick-release clamps equipped with a stainless steel swing screw

## Ecodesign

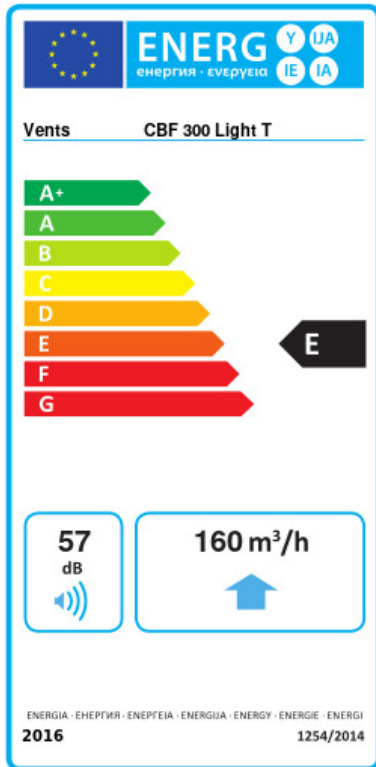

Trademark	Vents					
Model	CBF 300 Light T					
Specific energy consumption (SEC) (kWh/(m <sup>2</sup> /a))	Cold		Average		Warm	
	-32.1	B	-14.2	E	-3.9	F
Type of ventilation unit	Unidirectional					
Type of drive installed	2-speed					
Type of heat recovery system	None					
Maximum flow rate (m <sup>3</sup> /h)	160					
Electric power input (W)	44					
Reference flow rate (m <sup>3</sup> /s)	0.044					
Reference pressure difference (Pa)	50					
Specific power input (SPI) (W/(m <sup>3</sup> /h))	0.156					
Control typology	Clock control					
Maximum external leakage rates (%)	2.7					
Declared typology	RVU UVU					
Sound power level (dB(A))	57					
The annual electricity consumption (AEC) (kWh/a)	Cold		Average		Warm	
	183		183		183	
The annual heating saved (AHS) (kWh/a)	Cold		Average		Warm	
	3667		1874		848	