

CBF 300 Light TP



Centrifugal ceiling fans with integrated LED-light

- Maximum airflow: 300
- Sound pressure level LpA at 3 m: 31
- Lighting
- Motor type: AC
- Control: Built-in control panel
- Casing material: Galvanized steel
- Backdraft protection: Backdraft damper
- Motion sensor
- Timer: Turn off timer

	Unit of measurement	CBF 300 Light TP	
Connected air duct size	mm	150	
Phases	-	1	
Minimum supply voltage	V	220	
Maximum supply voltage	V	240	
Power supply frequency	Hz	50/60	
Rated power	W	31	49
Unit current	A	0.15	0.22
Maximum airflow	m ³ /h	220	300
Sound pressure level LpA at 3 m	dB(A)	28	31
Weight	kg	5.1	
Ambient air temperature min	°C	1	
Ambient air temperature max	°C	40	
Ingress protection rating	-	IPX2	
ErP compliance	-	2016, 2018	
Cold - Specific energy consumption (SEC)	kWh/(m ² /a)	52.5	
SEC Class Cold	-	A+	
Average - Specific energy consumption (SEC)	kWh/(m ² /a)	25.4	
SEC Class Average	-	C	
Warm - Specific energy consumption (SEC)	kWh/(m ² /a)	9.9	
SEC Class Warm	-	F	
Unit category	-	RVU	

Type of ventilation unit	-	Unidirectional
Type of drive installed	-	2-speed
Type of heat recovery system	-	None
Maximum flow rate	m ³ /h	160
Electric power input	W	44
Reference flow rate	m ³ /s	0.044
Reference pressure difference	Pa	50
Specific power input (SPI)	W/(m ³ /h)	0.156
Control typology	-	Local demand control
Maximum external leakage rates	%	2.7
Cold - The annual electricity consumption (AEC)	kWh/a	116
Average - The annual electricity consumption (AEC)	kWh/a	116
Warm - Jährlicher Stromverbrauch (JSV)	kWh/a	116
Cold - The annual heating saved (AHS)	kWh/a	5536
The annual heating saved (AHS) Average	kWh/a	2830
The annual heating saved (AHS) Warm	kWh/a	1280
Sound power level	dB(A)	57
Declared typology	-	RVU UVU

Dimensions

D	L1	A	B	C	E	H	h	a	b
149	50	330	258	260	395	188	62	208	123

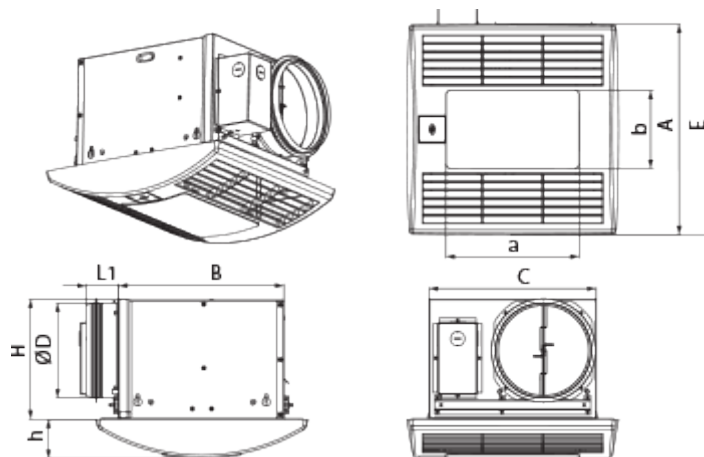



Accessories

Speed control switches

Name	Photo	Description
------	-------	-------------

P2-10		Turning fan on/off and speed switching for multispeed fans
-----------------------	---	--

Other accessories

Name	Photo	Description
MV 152 bVs N		Supply and exhaust metal hoods
MV 152 V ASA		Supply and exhaust hoods



Flexible ducts

Name	Photo	Description
Polyvent 660		Flexible PVC film non-insulated air ducts with steel wire frame (65 µm)

Other accessories

Name	Photo	Description
CB 60-165		The clamps are designed for quick and reliable mounting and connection of various round ventilation system components. Clamps are the stainless steel quick-release clamps equipped with a stainless steel swing screw

Electrical accessories

Name	Photo	Description
TP CBF		Motion sensor
CH-PLC-10WG23		10 W LED light with colour temperature 3000 K