

# CBF LP 200 TP



## Centrifugal ceiling fans

- Maximum airflow: 210
- Sound pressure level LpA at 3 m: 27
- Motor type: AC
- Control: Built-in control panel
- Casing material: Galvanized steel
- Backdraft protection: Backdraft damper
- Motion sensor
- Timer: Turn off timer, Turn on timer

	Unit of measurement	CBF LP 200 TP	
Connected air duct size	mm	100	
Phases	-	1	
Minimum supply voltage	V	220	
Maximum supply voltage	V	240	
Power supply frequency	Hz	50/60	
Rated power	W	20	29
Unit current	A	0.1	0.13
Maximum airflow	m <sup>3</sup> /h	130	210
Sound pressure level LpA at 3 m	dB(A)	24	27
Weight	kg	5.3	
Ambient air temperature min	°C	1	
Ambient air temperature max	°C	40	
Ingress protection rating	-	IPX4	

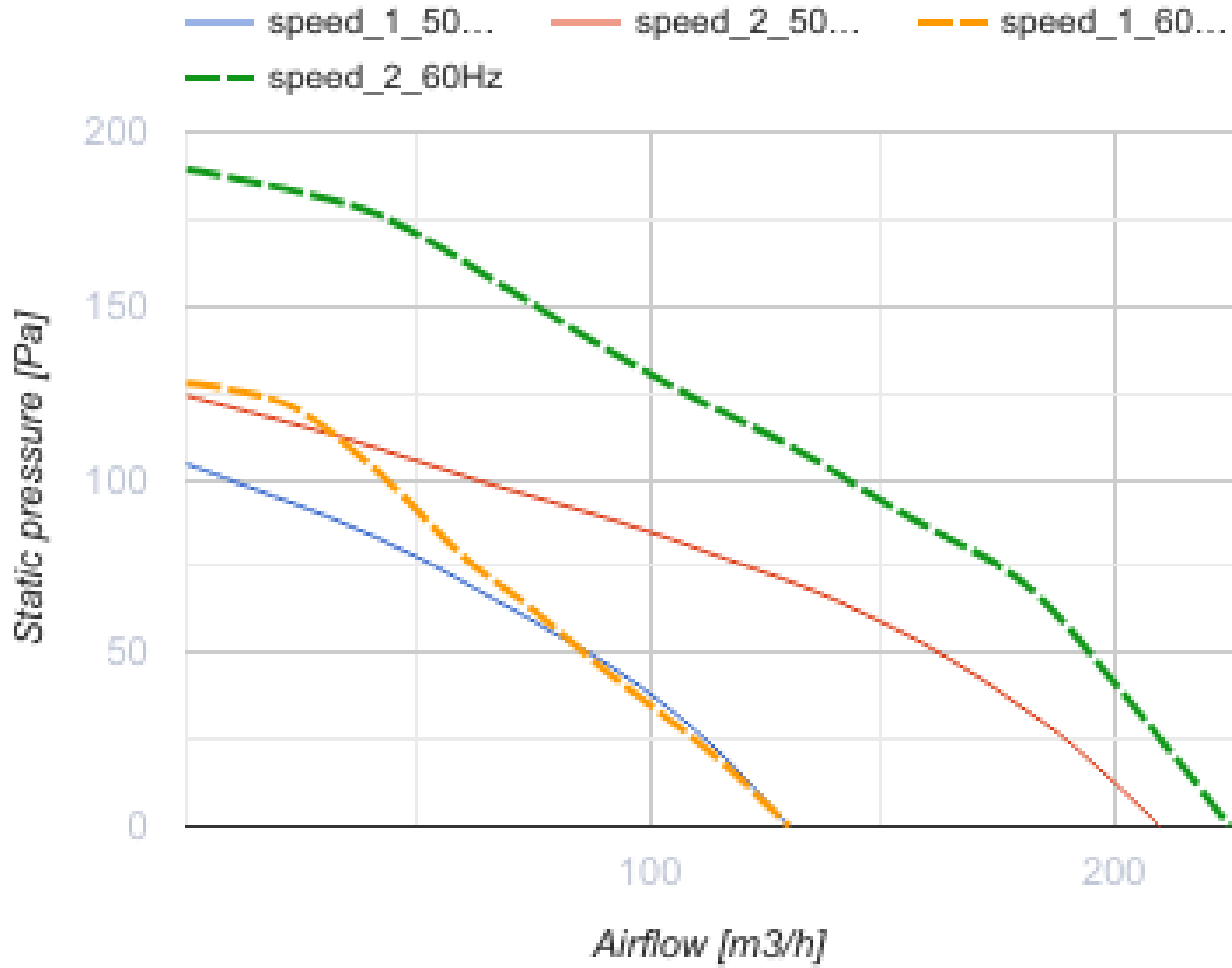

## Dimensions

d	L1	L2	A	B	C	E	H	h	G
98	100	40.5	330	278	255	395	134	18	max 620



## Accessories

### Speed control switches

Name	Photo	Description
<a href="#">P2-10</a>		Turning fan on/off and speed switching for multispeed fans

### Metal

Name	Photo	Description
<a href="#">MVM 102 bVs N</a>		Supply and exhaust metal hoods

### Other accessories

Name	Photo	Description
MV 102 V ASA		Supply and exhaust hoods

### Flexible ducts

Name	Photo	Description
<a href="#">Polyvent 660</a>		Flexible PVC film non-insulated air ducts with steel wire frame (65 µm)

**Other accessories**

Name	Photo	Description
<a href="#">CB 60-110</a>		The clamps are designed for quick and reliable mounting and connection of various round ventilation system components. Clamps are the stainless steel quick-release clamps equipped with a stainless steel swing screw

**Electrical accessories**

Name	Photo	Description
<a href="#">TP CBF</a>		Motion sensor

## Ecodesign

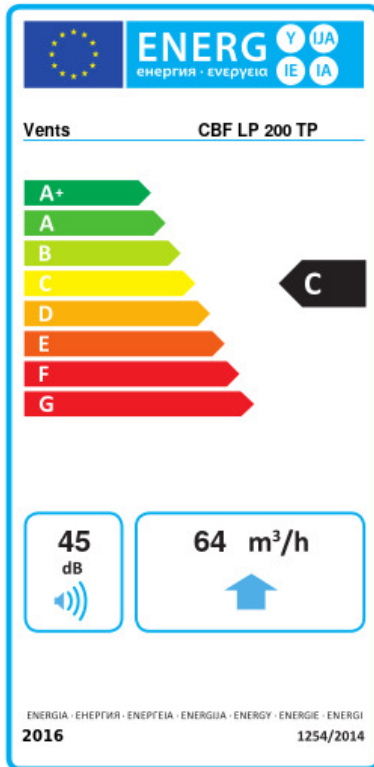

Trademark	Vents					
Model	CBF LP 200 TP					
Specific energy consumption (SEC) (kWh/(m <sup>2</sup> /a))	Cold	Average	Warm			
	51.4	A+	24.3	C	8.8	F
Type of ventilation unit	Unidirectional					
Type of drive installed	2-speed					
Type of heat recovery system	None					
Maximum flow rate (m <sup>3</sup> /h)	64					
Electric power input (W)	25.5					
Reference flow rate (m <sup>3</sup> /s)	0.024					
Reference pressure difference (Pa)	50					
Specific power input (SPI) (W/(m <sup>3</sup> /h))	0.212					
Control typology	Local demand control					
Maximum external leakage rates (%)	2.7					
Sound power level (dB(A))	45					
Declared typology	RVU UVU					
The annual electricity consumption (AEC) (kWh/a)	Cold	Average	Warm			
	158	158	158			
The annual heating saved (AHS) (kWh/a)	Cold	Average	Warm			
	5536	2830	1280			