

# Enave 210 V A21 L



Heat recovery air handling units in sound- and heat-insulated casings made of expanded polypropylene

- Maximum airflow: 255
- Sound pressure level LpA at 3 m: 34
- Heat exchanger type: Counter flow
- Extract filter: G4 / Coarse > 60%
- Supply filter: G4 / Coarse > 60% (option F7 / ePM1 60%)
- Sound insulation
- Motor type: EC
- Bypass: Auto
- Reheater: Optional
- Preheater: Optional
- BMS protocol: ModBus
- Control: Smartphone
- Casing material: EPP
- Humidity sensor: Optional
- CO2 sensor: Optional
- VOC sensor: Optional
- PM2.5 sensor: Optional

	Unit of measurement	Enave 210 V A21 L
Connected air duct size	mm	125
Phases	-	1
Minimum supply voltage	V	230
Maximum supply voltage	V	230
Power supply frequency	Hz	50/60
Rated power	W	114
Unit current	A	0.92
Maximum airflow	m <sup>3</sup> /h	255
Sound pressure level LpA at 3 m	dB(A)	34
Heat recovery efficiency, max	%	92
Heat exchanger type	-	Counter flow
Heat exchanger material	-	Polystyrene
Weight	kg	20
Extract filter	-	G4 / Coarse > 60%
Supply filter	-	G4 / Coarse > 60% (option F7 / ePM1 60%)
Transported air temperature (max)	°C	40
Transported air temperature (min)	°C	-25
Ambient air temperature min	°C	1
Ambient air temperature max	°C	40
Ambient air humidity max	%	60
Ingress protection rating	-	IP22

Ingress protection rating of the drive	-	IP44
--	---	------

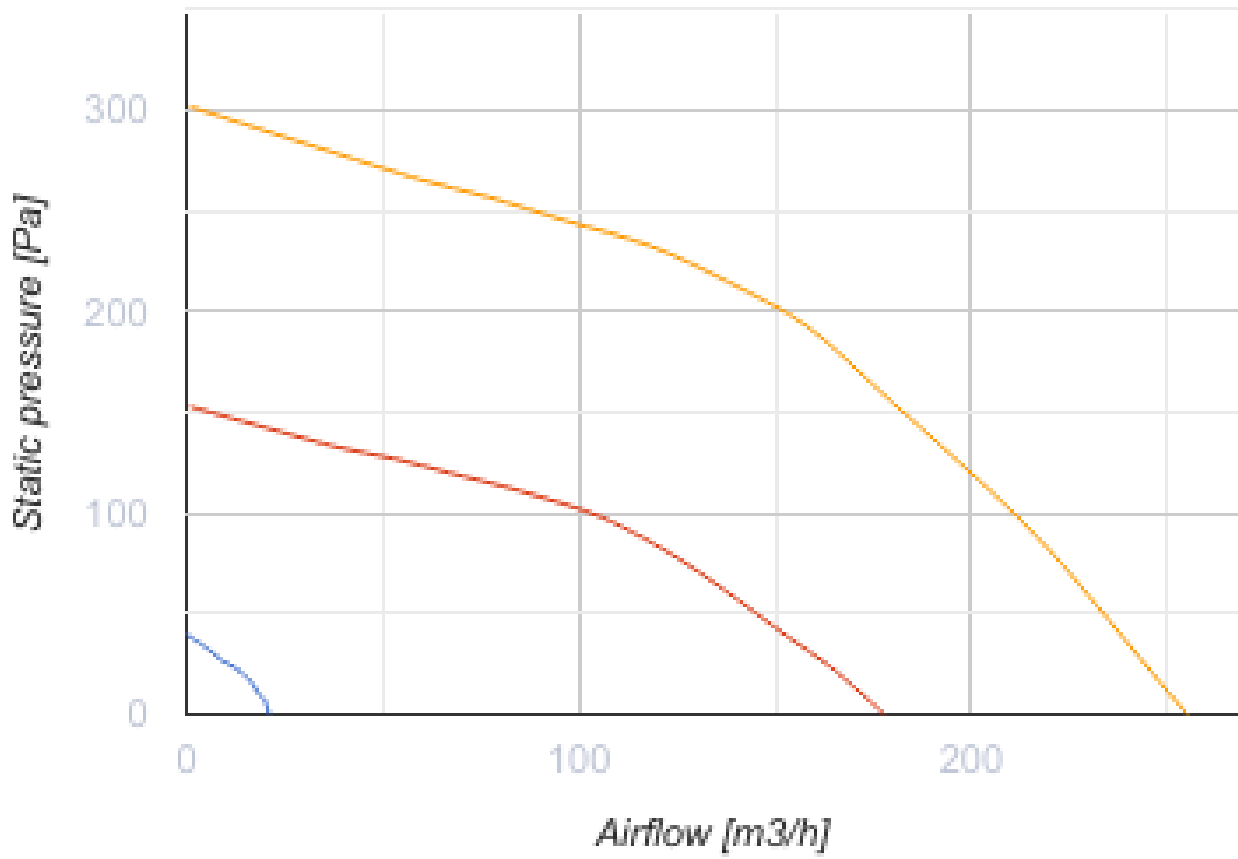



## Dimensions

Ø D	H	H1	L	L1	W	W1
125	852	909	419	160	600	273





## Accessories





### Other accessories

Name	Photo	Description
SF 356x100x48 Coarse 90% G4		Panel filter G4
SF 356x100x48 ePM1 65% F7		F7 panel filter

### Control Panels for AHU

Name	Photo	Description
<a href="#">A25</a>		The control panel with a sensor display
<a href="#">A22</a>		The A22/A22 WiFi control panels are used for control of industrial and domestic air handling units with an A21 automation system.
<a href="#">A22 WiFi</a>		The A22/A22 WiFi control panels are used for control of industrial and domestic air handling units with an A21 automation system.

### Sensors

Name	Photo	Description
<a href="#">HV2</a>		Humidity sensor
<a href="#">CO2-3</a>		CO2 sensor
<a href="#">CO2-1</a>		CO2 sensors
<a href="#">CO2-2</a>		CO2 sensors
<a href="#">HR-S</a>		Electro-mechanical humidistats

### Electrical heaters



Name	Photo	Description
------	-------	-------------

<a href="#">NKP 125-0,6-1 A21 V.2</a>		Heater for heat exchanger freeze protection
<a href="#">NKP 125-0,8-1 A21 V.2</a>		Heater for heat exchanger freeze protection
<a href="#">NKP 125-1,2-1 A21 V.2</a>		Heater for heat exchanger freeze protection
<a href="#">NKD 125-0,6-1 A21 V.2</a>		Duct heater for supply air post-heating with external control
<a href="#">NKD 125-0,8-1 A21 V.2</a>		Duct heater for supply air post-heating with external control
<a href="#">NKD 125-1,2-1 A21 V.2</a>		Duct heater for supply air post-heating with external control

### Condensation drainage

Name	Photo	Description
<a href="#">SH-32</a>		The hydraulic U-trap for condensate drainage from heat exchangers and coolers in ventilation and air conditioning systems

### For round ducts

Name	Photo	Description
<a href="#">SR 125/600</a>		Silencer is applied for noise absorption produced during the ventilating equipment operation and spread along the ducting systems
<a href="#">SR 125/900</a>		Silencer is applied for noise absorption produced during the ventilating equipment operation and spread along the ducting systems
<a href="#">SR 125/1200</a>		Silencer is applied for noise absorption produced during the ventilating equipment operation and spread along the ducting systems

### For round ducts

Name	Photo	Description
<a href="#">KRV 125</a>		Air damper for air flow cut-off in round air ducts

### Electric actuators

Name	Photo	Description
------	-------	-------------

[Belimo TF230](#)



The actuators are designed for controlling air dampers with cross section up to 0.4 m<sup>2</sup> performing protection functions