

Enave 350 V L A21



Heat recovery air handling units in sound- and heat-insulated casings made of expanded polypropylene

- Maximum airflow: 410
- Sound pressure level LpA at 3 m: 26
- Heat exchanger type: Counter flow
- Extract filter: Coarse > 60 %
- Supply filter: Coarse > 60 % (option ePM1 60 %)
- Sound insulation
- Motor type: EC
- Bypass: Auto
- Reheater: Optional
- Preheater: Optional
- BMS protocol: ModBus
- Control: Smartphone
- Casing material: EPP
- Humidity sensor: Optional
- CO2 sensor: Optional
- VOC sensor: Optional
- PM2.5 sensor: Optional

	Unit of measurement	Enave 350 V L A21
Connected air duct size	mm	160
Speed	-	1
Phases	-	1
Minimum supply voltage	V	230
Maximum supply voltage	V	230
Power supply frequency	Hz	50/60
Rated power	W	213
Unit current	A	1.62
Maximum airflow	m ³ /h	410
Sound pressure level LpA at 3 m	dB(A)	26
Heat recovery efficiency, max	%	93
Heat exchanger type	-	Counter flow
Heat exchanger material	-	Polystyrene
Weight	kg	26
Extract filter	-	Coarse > 60 %
Supply filter	-	Coarse > 60 % (option ePM1 60 %)
Transported air temperature (max)	°C	40
Transported air temperature (min)	°C	-25
Ambient air temperature min	°C	1
Ambient air temperature max	°C	40
Ambient air humidity max	%	60

Ingress protection rating	-	IP22
Ingress protection rating of the drive	-	IP44

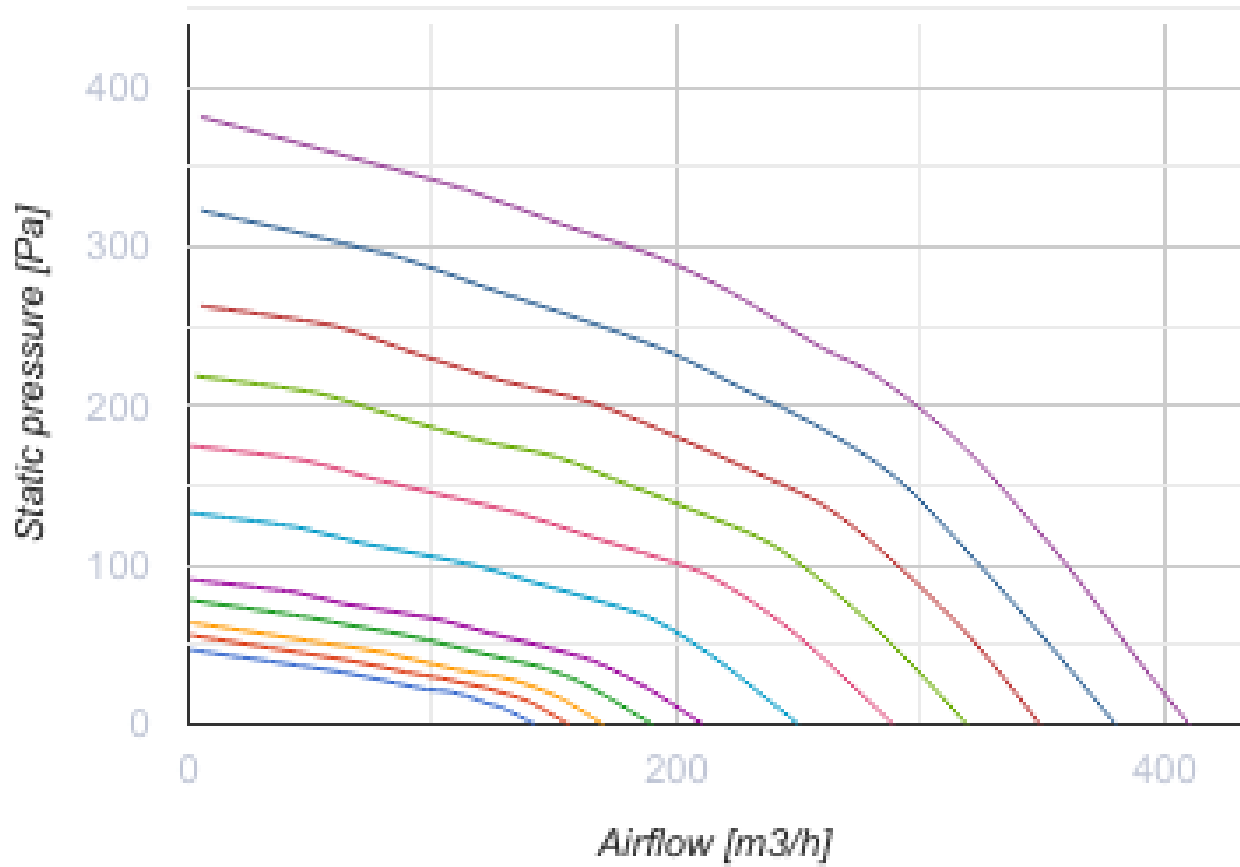

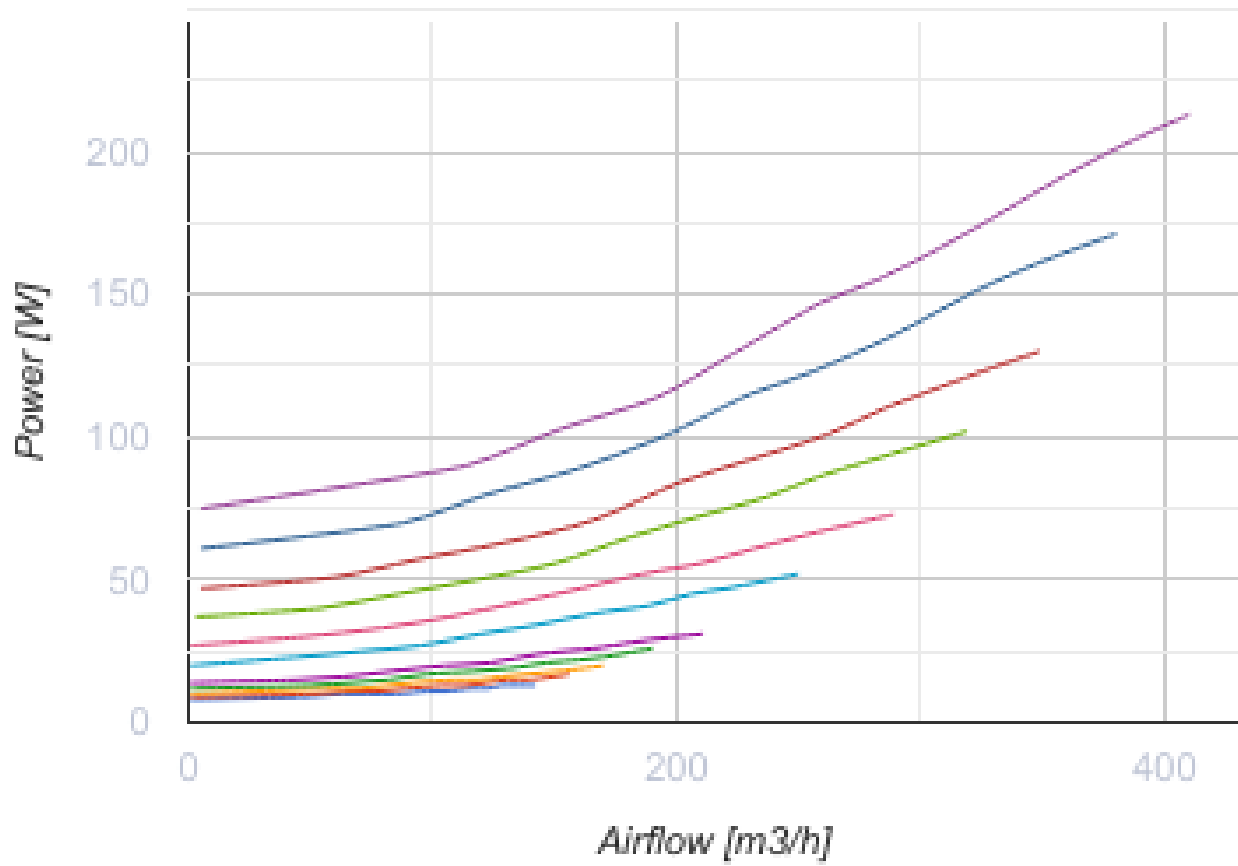

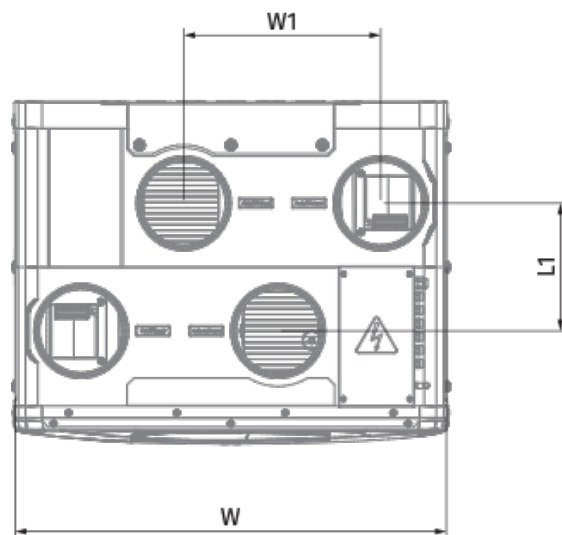
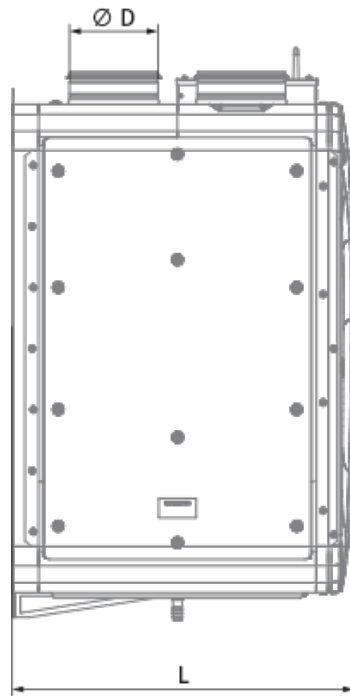
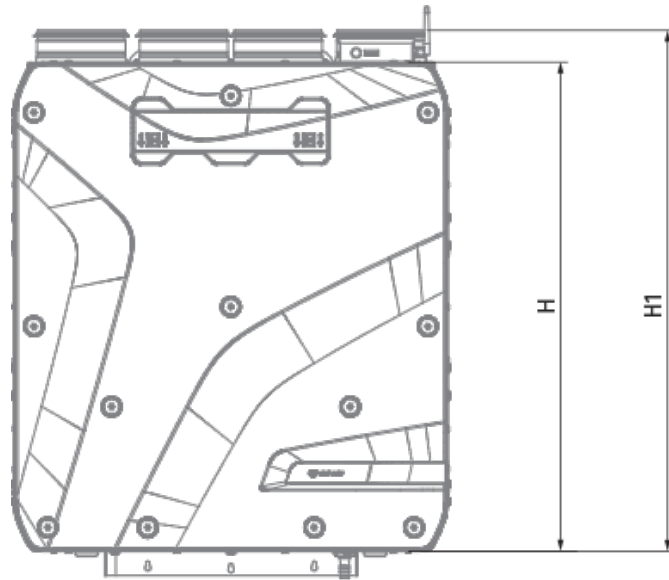

Dimensions

Ø D	H	H1	L	L1	W	W1
160	880	939	616	230	770	355





Accessories





Other accessories

Name	Photo	Description
SF 496x150x60 Coarse 90% G4		Panel filter G4
SF 496x150x60 ePM1 65% F7		F7 panel filter

Control Panels for AHU

Name	Photo	Description
A25		The control panel with a sensor display
A22		The A22/A22 WiFi control panels are used for control of industrial and domestic air handling units with an A21 automation system.
A22 WiFi		The A22/A22 WiFi control panels are used for control of industrial and domestic air handling units with an A21 automation system.

Sensors

Name	Photo	Description
HV2		Humidity sensor
CO2-3		CO2 sensor
CO2-1		CO2 sensors
CO2-2		CO2 sensors
HR-S		Electro-mechanical humidistats

Electrical heaters



Name	Photo	Description
------	-------	-------------

NKP 160-0,8-1 A21 V.2		Heater for heat exchanger freeze protection
NKP 160-1,2-1 A21 V.2		Heater for heat exchanger freeze protection
NKP 160-1,7-1 A21 V.2		Heater for heat exchanger freeze protection
NKP 160-2,0-1 A21 V.2		Heater for heat exchanger freeze protection
NKD 160-0,8-1 A21 V.2		Duct heater for supply air post-heating with external control
NKD 160-1,2-1 A21 V.2		Duct heater for supply air post-heating with external control
NKD 160-1,7-1 A21 V.2		Duct heater for supply air post-heating with external control
NKD 160-2,0-1 A21 V.2		Duct heater for supply air post-heating with external control

Condensation drainage

Name	Photo	Description
SH-32		The hydraulic U-trap for condensate drainage from heat exchangers and coolers in ventilation and air conditioning systems

For round ducts

Name	Photo	Description
SR 160/600		Silencer is applied for noise absorption produced during the ventilating equipment operation and spread along the ducting systems
SR 160/900		Silencer is applied for noise absorption produced during the ventilating equipment operation and spread along the ducting systems
SR 160/1200		Silencer is applied for noise absorption produced during the ventilating equipment operation and spread along the ducting systems

For round ducts

Name	Photo	Description
------	-------	-------------

KRV 160		Air damper for air flow cut-off in round air ducts
-------------------------	---	--

Electric actuators

Name	Photo	Description
Belimo TF230		The actuators are designed for controlling air dampers with cross section up to 0.4 m ² performing protection functions

