

Enave-T 210 VE A21 R

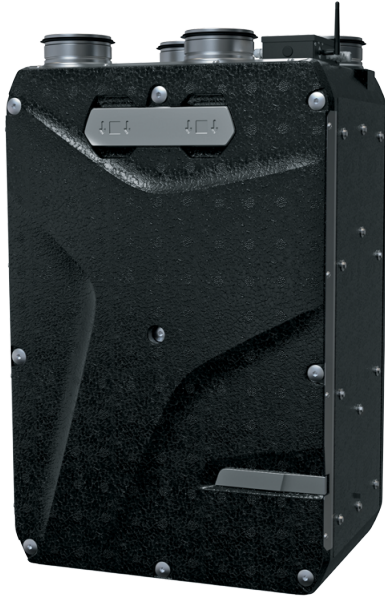

Vertical air handling units with a counterflow polystyrene heat exchanger

- Power of electrical preheater: 800
- Maximum airflow: 255
- Sound pressure level LpA at 3 m: 34
- Heat exchanger type: Counter flow
- Extract filter: G4 / Coarse > 60%
- Supply filter: G4 / Coarse > 60% (option F7 / ePM1 60%)
- Sound insulation
- Motor type: EC
- Enthalpy heat exchanger
- Bypass: Auto
- Reheater: Optional
- Preheater: Built-in
- BMS protocol: ModBus
- Control: Smartphone
- Casing material: EPP
- Humidity sensor: Optional
- CO2 sensor: Optional
- VOC sensor: Optional
- PM2.5 sensor: Optional

	Unit of measurement	Enave-T 210 VE A21 R
Connected air duct size	mm	125
Phases	-	1
Minimum supply voltage	V	230
Maximum supply voltage	V	230
Power supply frequency	Hz	50/60
Rated power	W	114
Power of electrical preheater	W	800
Unit current	A	4.47
Maximum airflow	m ³ /h	255
Sound pressure level LpA at 3 m	dB(A)	34
Heat recovery efficiency, max	%	83
Heat exchanger type	-	Counter flow
Heat exchanger material	-	Enthalpy
Weight	kg	20
Extract filter	-	G4 / Coarse > 60%
Supply filter	-	G4 / Coarse > 60% (option F7 / ePM1 60%)
Transported air temperature (max)	°C	40
Transported air temperature (min)	°C	-25
Ambient air temperature min	°C	1

Ambient air temperature max	°C	40
Ambient air humidity max	%	60
Ingress protection rating	-	IP22
Ingress protection rating of the drive	-	IP44

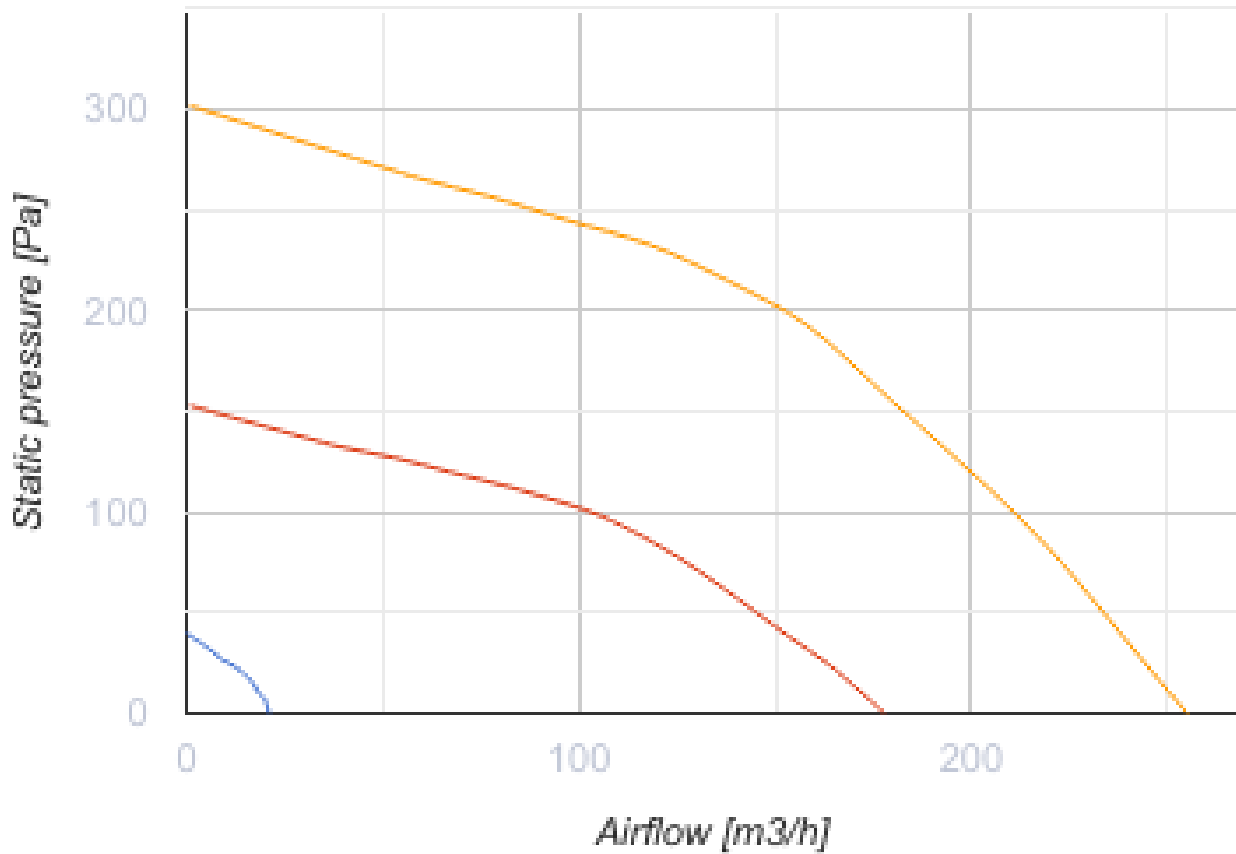



Dimensions

Ø D	H	H1	L	L1	W	W1
125	852	909	419	160	600	273





Accessories





Other accessories

Name	Photo	Description
SF 356x100x48 Coarse 90% G4		Panel filter G4
SF 356x100x48 ePM1 65% F7		F7 panel filter

Control Panels for AHU



Name	Photo	Description
A25		The control panel with a sensor display
A22		The A22/A22 WiFi control panels are used for control of industrial and domestic air handling units with an A21 automation system.
A22 WiFi		The A22/A22 WiFi control panels are used for control of industrial and domestic air handling units with an A21 automation system.

Sensors



Name	Photo	Description
HV2		Humidity sensor
CO2-3		CO2 sensor
CO2-1		CO2 sensors
CO2-2		CO2 sensors
HR-S		Electro-mechanical humidistats

Electrical heaters

Name	Photo	Description
------	-------	-------------

NKD 125-0,6-1 A21 V.2		Duct heater for supply air post-heating with external control
NKD 125-0,8-1 A21 V.2		Duct heater for supply air post-heating with external control
NKD 125-1,2-1 A21 V.2		Duct heater for supply air post-heating with external control

For round ducts

Name	Photo	Description
SR 125/600		Silencer is applied for noise absorption produced during the ventilating equipment operation and spread along the ducting systems
SR 125/900		Silencer is applied for noise absorption produced during the ventilating equipment operation and spread along the ducting systems
SR 125/1200		Silencer is applied for noise absorption produced during the ventilating equipment operation and spread along the ducting systems

For round ducts

Name	Photo	Description
KRV 125		Air damper for air flow cut-off in round air ducts

Electric actuators

Name	Photo	Description
Belimo TF230		The actuators are designed for controlling air dampers with cross section up to 0.4 m ² performing protection functions