

Enave-T 270 V A14 R

Heat recovery air handling units in sound- and heat-insulated casings made of expanded polypropylene



- Maximum airflow: 304
- Sound pressure level LpA at 3 m: 37
- Heat exchanger type: Counter flow
- Extract filter: G4 / Coarse > 60%
- Supply filter: G4 / Coarse > 60% (option F7 / ePM1 60%)
- Sound insulation
- Motor type: EC
- Enthalpy heat exchanger
- Bypass: Manual
- Control: Wired control panel
- Casing material: EPP
- Humidity sensor: Optional
- CO2 sensor: Optional
- VOC sensor: Optional
- PM2.5 sensor: Optional

	Unit of measurement	Enave-T 270 V A14 R
Connected air duct size	mm	125
Phases	-	1
Minimum supply voltage	V	230
Maximum supply voltage	V	230
Power supply frequency	Hz	50/60
Rated power	W	176
Unit current	A	1.34
Maximum airflow	m ³ /h	304
Sound pressure level LpA at 3 m	dB(A)	37
Heat recovery efficiency, max	%	84
Heat exchanger type	-	Counter flow
Heat exchanger material	-	Enthalpy
Weight	kg	22
Extract filter	-	G4 / Coarse > 60%
Supply filter	-	G4 / Coarse > 60% (option F7 / ePM1 60%)
Transported air temperature (max)	°C	40
Transported air temperature (min)	°C	-25
Ambient air temperature min	°C	1
Ambient air temperature max	°C	40
Ambient air humidity max	%	60
Ingress protection rating	-	IP22

Ingress protection rating of the drive	-	IP44
--	---	------

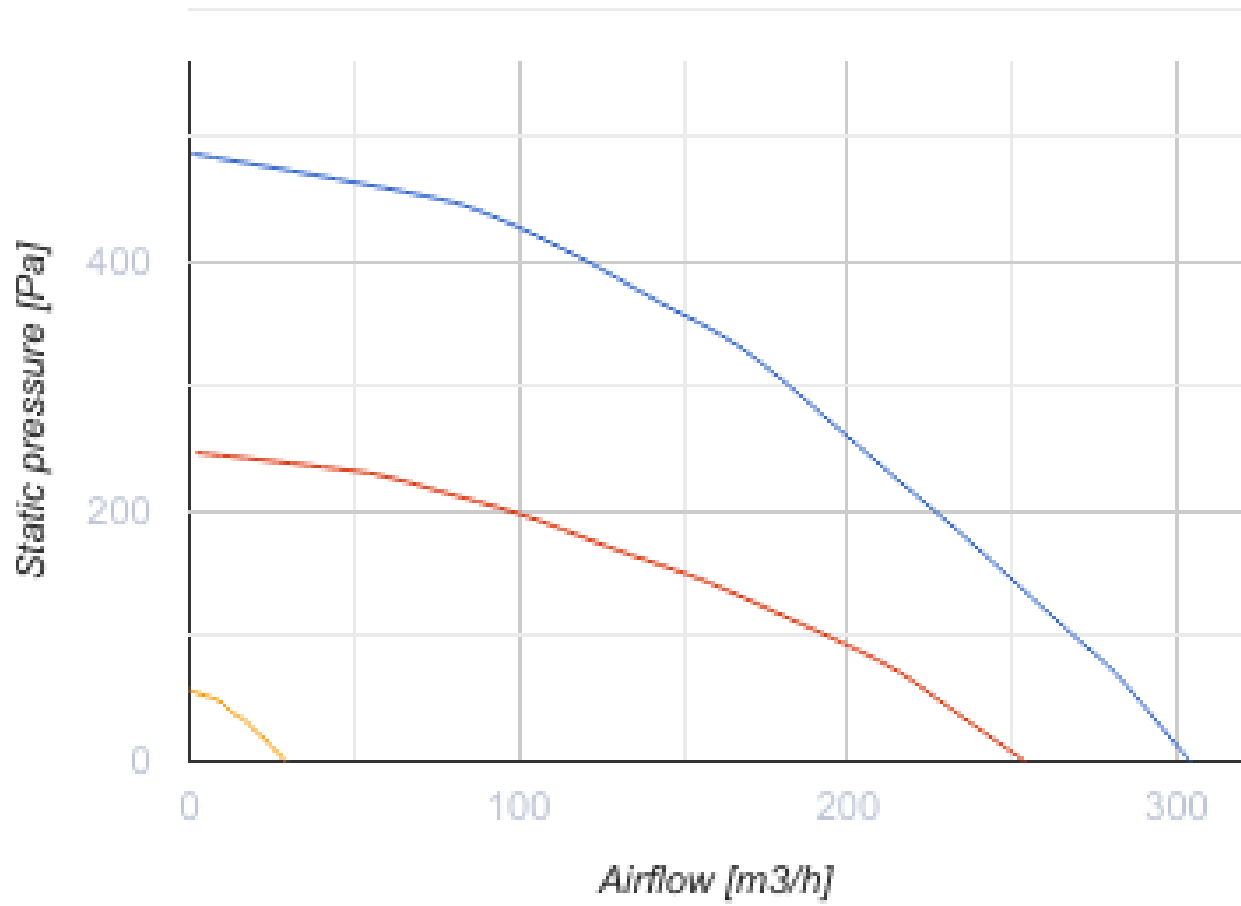

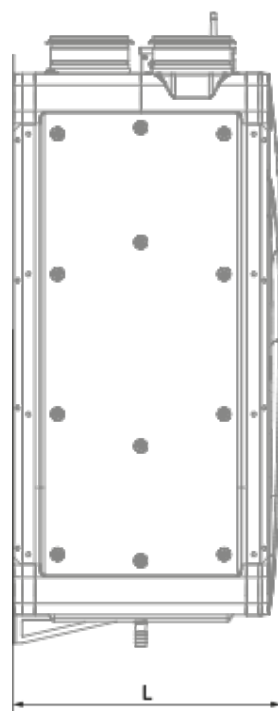

Dimensions

Ø D	H	H1	L	L1	W	W1
125	852	909	419	160	600	273







Accessories



Other accessories

Name	Photo	Description
SF 356x100x48 Coarse 90% G4		Panel filter G4
SF 356x100x48 ePM1 65% F7		F7 panel filter

Sensors

Name	Photo	Description
HV2		Humidity sensor
CO2-3		CO2 sensor
CO2-1		CO2 sensors
CO2-2		CO2 sensors
HR-S		Electro-mechanical humidistats

For round ducts

Name	Photo	Description
SR 125/600		Silencer is applied for noise absorption produced during the ventilating equipment operation and spread along the ducting systems
SR 125/900		Silencer is applied for noise absorption produced during the ventilating equipment operation and spread along the ducting systems
SR 125/1200		Silencer is applied for noise absorption produced during the ventilating equipment operation and spread along the ducting systems

For round ducts

Name	Photo	Description
------	-------	-------------

KRV 125		Air damper for air flow cut-off in round air ducts
-------------------------	---	--

Electric actuators

Name	Photo	Description
Belimo TF230		The actuators are designed for controlling air dampers with cross section up to 0.4 m ² performing protection functions