

Enave-T 550 V A14 L



Heat recovery air handling units in sound- and heat-insulated casings made of expanded polypropylene

- Maximum airflow: 660
- Sound pressure level LpA at 3 m: 57
- Heat exchanger type: Counter flow
- Extract filter: Coarse > 60 %
- Supply filter: Coarse > 60 % (option ePM1 60 %)
- Sound insulation
- Motor type: EC
- Enthalpy heat exchanger
- Bypass: Manual
- Control: Wired control panel
- Casing material: EPP
- Humidity sensor: Optional
- CO2 sensor: Optional

	Unit of measurement	Enave-T 550 V A14 L
Connected air duct size	mm	200
Phases	-	1
Minimum supply voltage	V	230
Maximum supply voltage	V	230
Power supply frequency	Hz	50/60
Rated power	W	347
Unit current	A	2.4
Maximum airflow	m ³ /h	660
Sound pressure level LpA at 3 m	dB(A)	57
Heat recovery efficiency, max	%	80
Heat exchanger type	-	Counter flow
Heat exchanger material	-	Enthalpy
Weight	kg	28
Extract filter	-	Coarse > 60 %
Supply filter	-	Coarse > 60 % (option ePM1 60 %)
Transported air temperature (max)	°C	40
Transported air temperature (min)	°C	-25
Ambient air temperature min	°C	1
Ambient air temperature max	°C	40
Ambient air humidity max	%	60
Ingress protection rating	-	IP22

Ingress protection rating of the drive	-	IP44
--	---	------

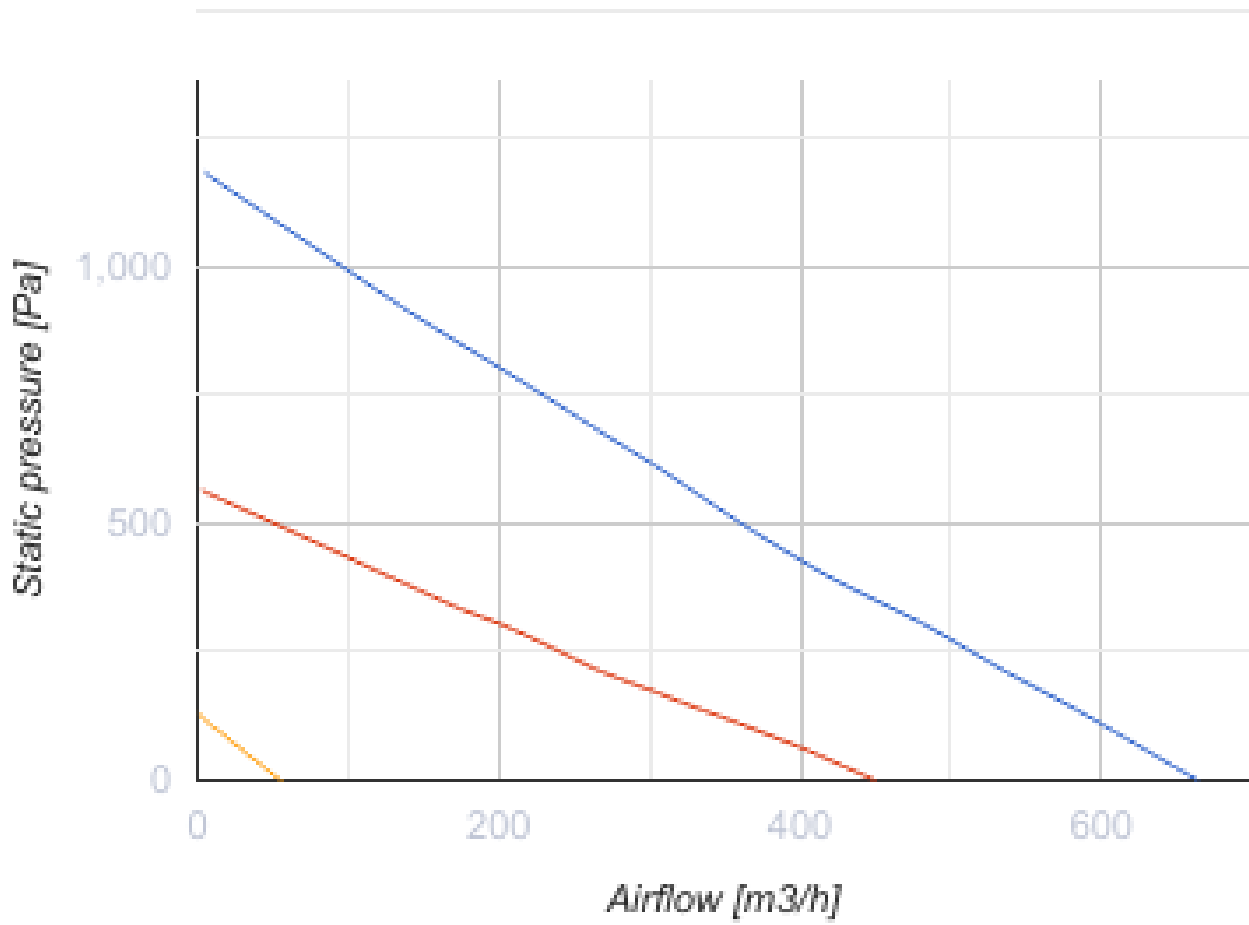

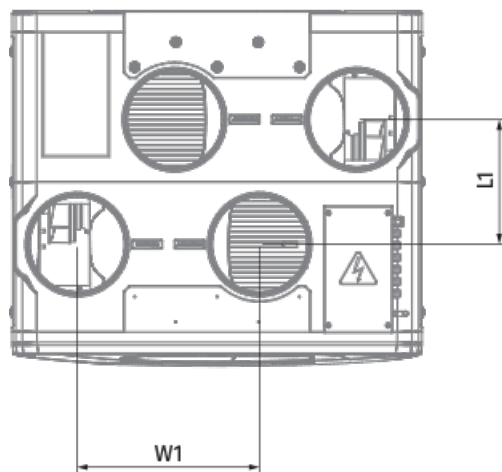
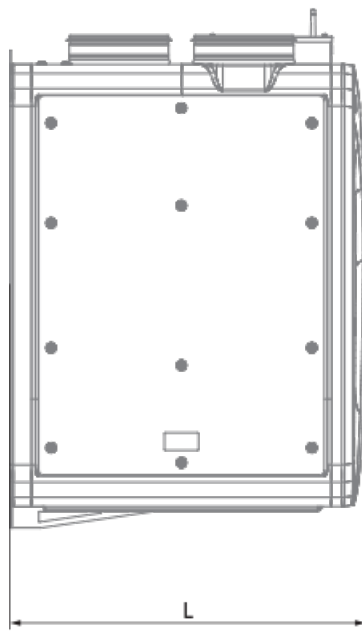
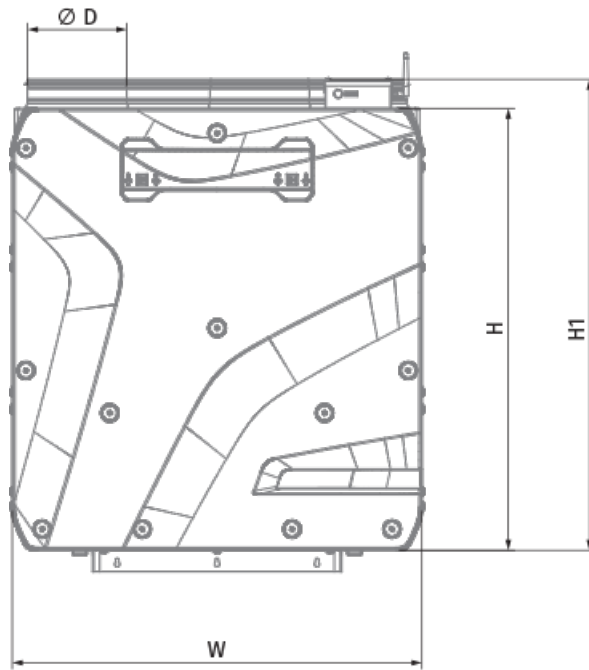

Dimensions

Ø D	H	H1	L	L1	W	W1
200	885	943	711	250	820	365







Accessories



Other accessories

Name	Photo	Description
SF 596x164x60 Coarse 90% G4		Panel filter G4
SF 596x164x60 ePM1 F7		F7 panel filter

Sensors

Name	Photo	Description
HV2		Humidity sensor
CO2-3		CO2 sensor
CO2-1		CO2 sensors
CO2-2		CO2 sensors
HR-S		Electro-mechanical humidistats

For round ducts

Name	Photo	Description
SR 200/600		Silencer is applied for noise absorption produced during the ventilating equipment operation and spread along the ducting systems
SR 200/900		Silencer is applied for noise absorption produced during the ventilating equipment operation and spread along the ducting systems
SR 200/1200		Silencer is applied for noise absorption produced during the ventilating equipment operation and spread along the ducting systems

For round ducts

Name	Photo	Description
------	-------	-------------

KRV 200		Air damper for air flow cut-off in round air ducts
-------------------------	---	--

Electric actuators

Name	Photo	Description
Belimo TF230		The actuators are designed for controlling air dampers with cross section up to 0.4 m ² performing protection functions