

# FlexiVent

## 060175/204x60

For connection of the air ducts to the connectors and air distribution boxes

- Casing material: Polypropylene

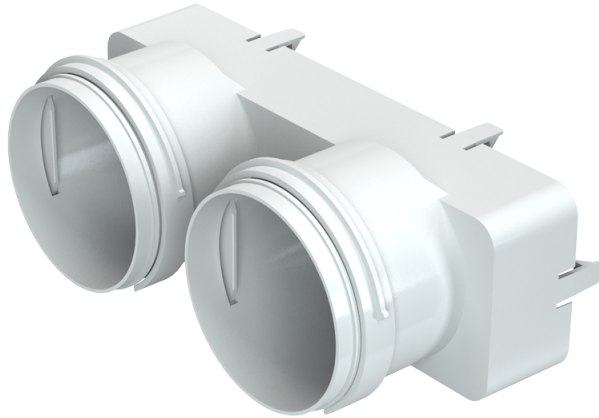

	Unit of measurement	FlexiVent 060175/204x60
Connected air duct size	mm	75
Ambient air temperature min	°C	-20
Ambient air temperature max	°C	60

### Dimensions

Ø D	Ø D1	H	L	W	W1
84	91	60	98	217	204

