

FlexiVent

1051125/75x6

Supply or exhaust ventilation systems of residential spaces. For distribution of air from the ventilation unit through the air ducts

- Casing material: Polypropylene

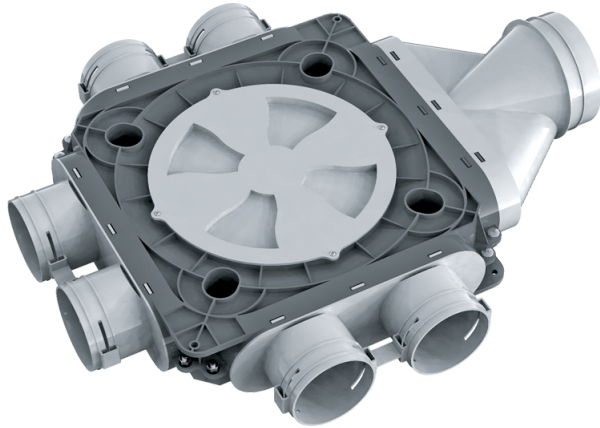

| | Unit of measurement | FlexiVent 1051125/75x6 |
|-----------------------------|---------------------|------------------------|
| Connected air duct size | mm | 75 |
| Ambient air temperature min | °C | -20 |
| Ambient air temperature max | °C | 60 |

Dimensions

| Ø d | H | L | W |
|-----|-----|-----|-----|
| 113 | 128 | 574 | 468 |

