

FlexiVent

1051125/90x6

Supply or exhaust ventilation systems of residential spaces. For distribution of air from the ventilation unit through the air ducts

- Casing material: Polypropylene

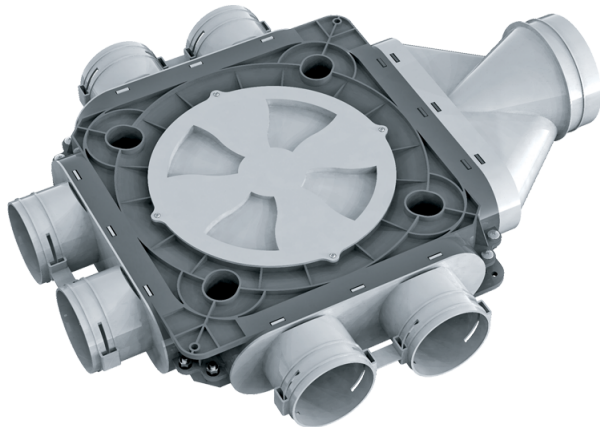

	Unit of measurement	FlexiVent 1051125/90x6
Connected air duct size	mm	90
Ambient air temperature min	°C	-20
Ambient air temperature max	°C	60

Dimensions

$\varnothing d$	H	L	W
113	128	588	496

