

KAM 125 Eco (KFK+GFK)



Chimney centrifugal fan for house heating system management using heat of chimney or fireplace. It can be also used as a base for backup heating source

- Maximum airflow: 350
- Sound pressure level LpA at 3 m: 37
- Motor type: AC
- Casing material: Galvanized steel

	Unit of measurement	KAM 125 Eco (KFK+GFK)
Phases	-	1
Minimum supply voltage	V	230
Maximum supply voltage	V	230
Power supply frequency	Hz	50
Rated power	W	32
Unit current	A	0.14
Maximum airflow	m ³ /h	350
Sound pressure level LpA at 3 m	dB(A)	37
Weight	kg	9.4
Transported air temperature (max)	°C	150
Ingress protection rating	-	IPX2



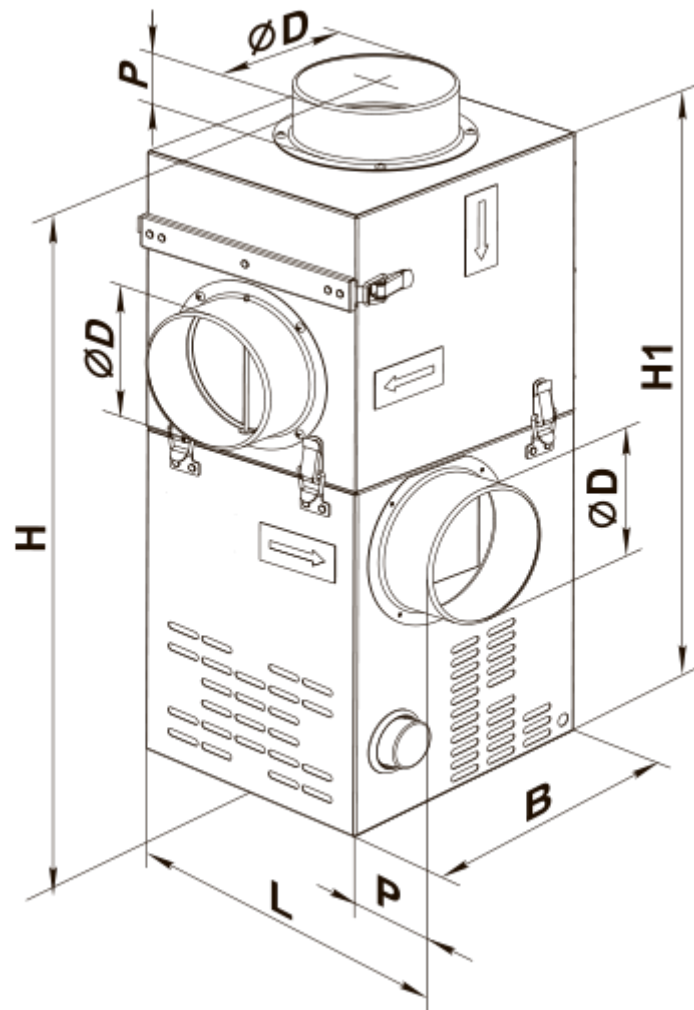

Dimensions













ØD	B	H	H1	L	P
124	245	580	530	260	50





Accessories

Speed controllers





Name	Photo	Description
RS-1-300		Speed controller
RS-1-400		Speed controller
RS-1 N		Speed controller
RS-1 V		Speed controller
RS-1.5 N		Speed controller

RS-1,5 V		Speed controller
RS-2 N		Speed controller
RS-2 V		Speed controller
RS-2,5 N		Speed controller
RS-2,5 V		Speed controller
RS-0,5-PS		Used in ventilation systems for switching on/off and speed control of single-phase fan motors with voltage control
RSA5E-2-P		Speed control enables not only selecting the comfortable ventilation mode for the periodically visited premises but reducing the energy consumption for the ventilation
RSA5E-2-M		Speed controls enables not only selecting the comfortable ventilation mode for the periodically visited premises but reducing the energy consumption for the ventilation
RSA5E-3-M		Speed controls enables not only selecting the comfortable ventilation mode for the periodically visited premises but reducing the energy consumption for the ventilation
RSA5E-4-M		Speed controls enables not only selecting the comfortable ventilation mode for the periodically visited premises but reducing the energy consumption for the ventilation
RSA5E-3,5-T		Speed controllers are applied for air flow control of single phase fans by means of motor step speed control
RSA5E-5,0-T		Speed controllers are applied for air flow control of single phase fans by means of motor step speed control



Temperature regulators

Name	Photo	Description
RT-10		Temperature regulator
TS-1-90		External temperature controller for chimney fans

Sensors

Name	Photo	Description
T-1,5 N		Humidity / light / motion sensors, timers
TH-1,5 N		Humidity / light / motion sensors, timers
TF-1,5 N		Humidity / light / motion sensors, timers
TP-1,5 N		Humidity / light / motion sensors, timers

Fittings

Name	Photo	Description
C 125		The clamps are designed for quick and reliable mounting and connection of various round ventilation system components. Clamps are made of stainless and galvanized steel band
CB 60-135		The clamps are designed for quick and reliable mounting and connection of various round ventilation system components. Clamps are the stainless steel quick-release clamps equipped with a stainless steel swing screw