

## KAM 150 Eco



Chimney centrifugal fan for house heating system management using heat of chimney or fireplace. It can be also used as a base for backup heating source

- Maximum airflow: 450
- Sound pressure level LpA at 3 m: 39
- Motor type: AC
- Casing material: Galvanized steel

	Unit of measurement	KAM 150 Eco
Phases	-	1
Minimum supply voltage	V	230
Maximum supply voltage	V	230
Power supply frequency	Hz	50
Rated power	W	43
Unit current	A	0.19
Maximum airflow	m <sup>3</sup> /h	450
Sound pressure level LpA at 3 m	dB(A)	39
Weight	kg	6.9
Transported air temperature (max)	°C	150
Ingress protection rating	-	IPX2





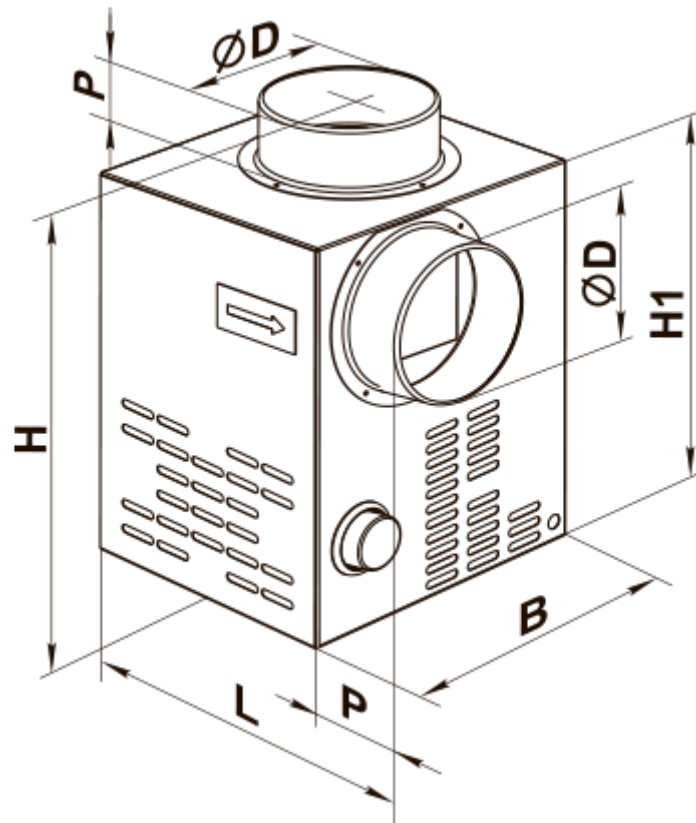

### Dimensions











ØD	B	H	H1	L	P
149	285	320	270	300	50





## Accessories

### Speed controllers

Name	Photo	Description
<a href="#">RS-1-300</a>		Speed controller
<a href="#">RS-1-400</a>		Speed controller
<a href="#">RS-1 N</a>		Speed controller
<a href="#">RS-1 V</a>		Speed controller
<a href="#">RS-1.5 N</a>		Speed controller
<a href="#">RS-1.5 V</a>		Speed controller
<a href="#">RS-2 N</a>		Speed controller



<a href="#">RS-2 V</a>		Speed controller
<a href="#">RS-2,5 N</a>		Speed controller
<a href="#">RS-2,5 V</a>		Speed controller
<a href="#">RS-0,5-PS</a>		Used in ventilation systems for switching on/off and speed control of single-phase fan motors with voltage control
<a href="#">RSA5E-2-P</a>		Speed control enables not only selecting the comfortable ventilation mode for the periodically visited premises but reducing the energy consumption for the ventilation
<a href="#">RSA5E-2-M</a>		Speed controls enables not only selecting the comfortable ventilation mode for the periodically visited premises but reducing the energy consumption for the ventilation
<a href="#">RSA5E-3-M</a>		Speed controls enables not only selecting the comfortable ventilation mode for the periodically visited premises but reducing the energy consumption for the ventilation
<a href="#">RSA5E-4-M</a>		Speed controls enables not only selecting the comfortable ventilation mode for the periodically visited premises but reducing the energy consumption for the ventilation
<a href="#">RSA5E-3,5-T</a>		Speed controllers are applied for air flow control of single phase fans by means of motor step speed control
<a href="#">RSA5E-5,0-T</a>		Speed controllers are applied for air flow control of single phase fans by means of motor step speed control

### Temperature regulators



Name	Photo	Description
<a href="#">RT-10</a>		Temperature regulator
<a href="#">TS-1-90</a>		External temperature controller for chimney fans

### Sensors

Name	Photo	Description
<a href="#">T-1,5 N</a>		Humidity / light / motion sensors, timers

<a href="#">TH-1,5 N</a>		Humidity / light / motion sensors, timers
<a href="#">TF-1,5 N</a>		Humidity / light / motion sensors, timers
<a href="#">TP-1,5 N</a>		Humidity / light / motion sensors, timers

### Fittings

Name	Photo	Description
<a href="#">C 150</a>		The clamps are designed for quick and reliable mounting and connection of various round ventilation system components. Clamps are made of stainless and galvanized steel band
<a href="#">CB 60-165</a>		The clamps are designed for quick and reliable mounting and connection of various round ventilation system components. Clamps are the stainless steel quick-release clamps equipped with a stainless steel swing screw