

KAM 160



Chimney centrifugal fan for house heating system management using heat of chimney or fireplace. It can be also used as a base for backup heating source

- Maximum airflow: 540
- Sound pressure level LpA at 3 m: 42
- Motor type: AC
- Casing material: Galvanized steel

	Unit of measurement	KAM 160
Phases	-	1
Minimum supply voltage	V	230
Maximum supply voltage	V	230
Power supply frequency	Hz	50
Rated power	W	116
Unit current	A	0.86
Maximum airflow	m ³ /h	540
Sound pressure level LpA at 3 m	dB(A)	42
Weight	kg	6.9
Transported air temperature (max)	°C	150
Ingress protection rating	-	IPX2





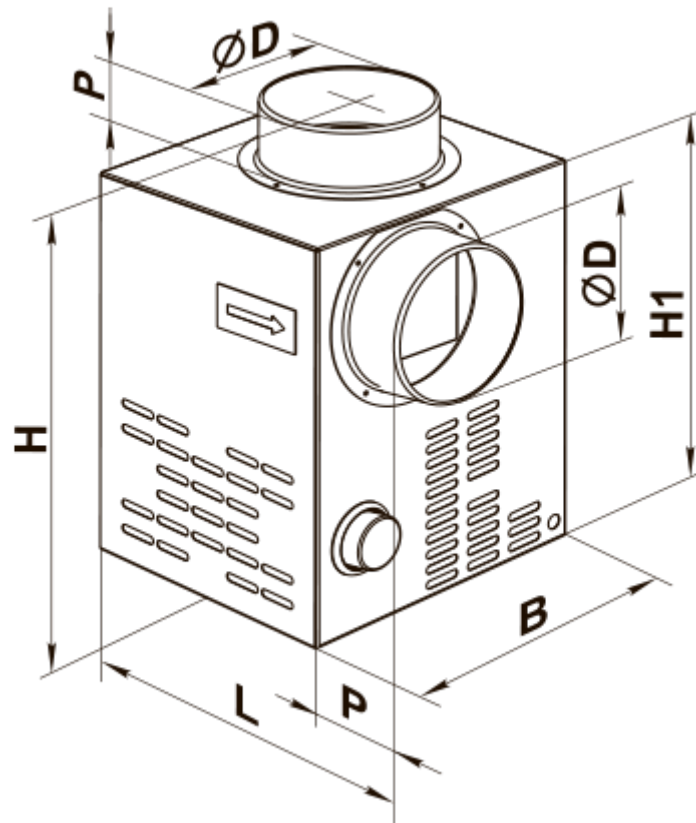

Dimensions



ØD	B	H	H1	L	P
159	285	350	300	300	50



Accessories



Speed controllers

Name	Photo	Description
RS-1-300		Speed controller
RS-1-400		Speed controller
RS-1 N		Speed controller
RS-1 V		Speed controller
RS-1.5 N		Speed controller
RS-1.5 V		Speed controller
RS-2 N		Speed controller





RS-2 V		Speed controller
RS-2,5 N		Speed controller
RS-2,5 V		Speed controller
RS-1,5-PS		Used in ventilation systems for switching on/off and speed control of single-phase fan motors with voltage control
RS-2,5-PS		Used in ventilation systems for switching on/off and speed control of single-phase fan motors with voltage control
RS-4,0-PS		Used in ventilation systems for switching on/off and speed control of single-phase fan motors with voltage control
RS-3,0-T		Applied in ventilation systems for speed switching ON/OFF and speed control of single-phase power-controlled motors
RS-5,0-T		Applied in ventilation systems for speed switching ON/OFF and speed control of single-phase power-controlled motors
RS-3,0-TA		Applied in ventilation systems for switching ON/OFF and speed controlling of single-phase power-controlled motors
RS-5,0-TA		Applied in ventilation systems for switching ON/OFF and speed controlling of single-phase power-controlled motors
RSA5E-2-P		Speed control enables not only selecting the comfortable ventilation mode for the periodically visited premises but reducing the energy consumption for the ventilation
RSA5E-2-M		Speed controls enables not only selecting the comfortable ventilation mode for the periodically visited premises but reducing the energy consumption for the ventilation
RSA5E-3-M		Speed controls enables not only selecting the comfortable ventilation mode for the periodically visited premises but reducing the energy consumption for the ventilation
RSA5E-4-M		Speed controls enables not only selecting the comfortable ventilation mode for the periodically visited premises but reducing the energy consumption for the ventilation
RSA5E-3,5-T		Speed controllers are applied for air flow control of single phase fans by means of motor step speed control

RSA5E-5.0-T		Speed controllers are applied for air flow control of single phase fans by means of motor step speed control
-----------------------------	---	--



Temperature regulators

Name	Photo	Description
RT-10		Temperature regulator
TS-1-90		External temperature controller for chimney fans

Sensors

Name	Photo	Description
T-1,5 N		Sensor
TH-1,5 N		Sensor
TF-1,5 N		Sensor
TP-1,5 N		Sensor

Other accessories

Name	Photo	Description
C 160		The clamps are designed for quick and reliable mounting and connection of various round ventilation system components. Clamps are made of stainless and galvanized steel band
CB 60-165		The clamps are designed for quick and reliable mounting and connection of various round ventilation system components. Clamps are the stainless steel quick-release clamps equipped with a stainless steel swing screw